

4035e/4045e
Dsm635/Dsm645
LDI35/LDI45
Aficio™ 2035e/2045e

Operating Instructions
General Settings Guide

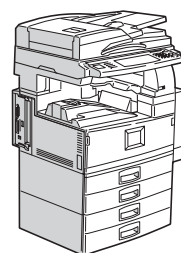

-
- 1** Getting Started
 - 2** Combined Function Operations
 - 3** Document Server
 - 4** User Tools (System Settings)
 - 5** Troubleshooting
 - 6** Remarks
 - 7** Entering Text
 - 8** Security
 - 9** Specifications



RICOH COMPANY, LTD.

15-5, Minami Aoyama 1-chome,
Minato-ku, Tokyo 107-8544, Japan
Phone: +81-3-3479-3111



Overseas Affiliates

U.S.A.

RICOH CORPORATION
5 Dedrick Place
West Caldwell, New Jersey 07006
Phone: +1-973-882-2000

The Netherlands

RICOH EUROPE B.V.
Groenelaan 3, 1186 AA, Amstelveen
Phone: +31-(0)20-5474111

United Kingdom

RICOH UK LTD.
Ricoh House,
1 Plane Tree Crescent, Feltham,
Middlesex, TW13 7HG
Phone: +44-(0)20-8261-4000

Germany

RICOH DEUTSCHLAND GmbH
Mergenthalerallee 38-40,
65760 Eschborn
Phone: +49-(0)6196-9060

France

RICOH FRANCE S.A.
383, Avenue du Général de Gaulle
BP 307-92143 Clamart Cedex
Phone: +33-(0)-821-01-74-26

Spain

RICOH ESPAÑA S.A.
Avda. Litoral Mar, 12-14,
Blue Building, Marina Village,
08005 Barcelona
Phone: +34-(0)93-295-7600

Italy

RICOH ITALIA SpA
Via della Metallurgia 12,
37139 Verona
Phone: +39-045-8181500

China

RICOH CHINA CO.,LTD.
29/F., Lippo Plaza, No.222
Huai Hai Zhong Road,
Lu Wan District,
Shanghai P.C.:200021
Phone: +86-21-5396-6888

Singapore

RICOH ASIA PACIFIC PTE.LTD.
260 Orchard Road,
#15-01/02 The Heeren,
Singapore 238855
Phone: +65-6830-5888

Introduction

This manual describes detailed instructions on the operation and notes about the use of this machine. To get maximum versatility from this machine all operators are requested to read this manual carefully and follow the instructions. Please keep this manual in a handy place near the machine.

Important

Contents of this manual are subject to change without prior notice. In no event will the company be liable for direct, indirect, special, incidental, or consequential damages as a result of handling or operating the machine.

Notes:

Some illustrations in this manual might be slightly different from the machine.

Certain options might not be available in some countries. For details, please contact your local dealer.

Laser Safety:

This machine is considered a class 1 laser device, safe for office/EDP use. The machine contains two GaAlAs laser diodes, 5-milliwatt, 760-800 nanometer wavelength for each emitter. Direct (or indirect reflected) eye contact with the laser beam might cause serious eye damage. Safety precautions and interlock mechanisms have been designed to prevent any possible laser beam exposure to the operator.

The following label is attached on the back side of the machine.

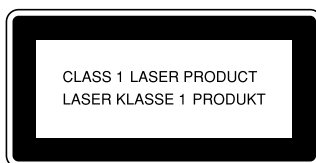

Warning:

Use of controls or adjustment or performance of procedures other than those specified in this manual might result in hazardous radiation exposure.

Notes:

The model names of the machines do not appear in the following pages. Check the type of your machine before reading this manual. (For details, see p.14 "Machine Types".)

- Type 1: Aficio 2035e
- Type 2: Aficio 2045e

Certain types might not be available in some countries. For details, please contact your local dealer.

Two kinds of size notation are employed in this manual. With this machine refer to the metric version.

For good copy quality, Ricoh recommends that you use genuine Ricoh toner.

Ricoh shall not be responsible for any damage or expense that might result from the use of parts other than genuine Ricoh parts with your Ricoh office products.

Power Source

220 - 240V, 50/60Hz, 8A or more

Please be sure to connect the power cord to a power source as above. For details about power source, see p.142 "Power Connection".



Declaration of Conformity

“The Product complies with the requirements of the EMC Directive 89/336/EEC and its amending directives and the Low Voltage Directive 73/23/EEC and its amending directives.”

In accordance with IEC 60417, this machine uses the following symbols for the main power switch:

I means **POWER ON.**

⏻ means **STAND BY.**

Introduction

This manual describes detailed instructions on the operation and notes about the use of this machine. To get maximum versatility from this machine all operators are requested to read this manual carefully and follow the instructions. Please keep this manual in a handy place near the machine.

Important

Contents of this manual are subject to change without prior notice. In no event will the company be liable for direct, indirect, special, incidental, or consequential damages as a result of handling or operating the machine.

For safe and correct use of this machine, please be sure to read the Safety Information before you use it.



Notes:

Some illustrations in this manual might be slightly different from the machine.

Certain options might not be available in some countries. For details, please contact your local dealer.



Laser Safety:

This machine is considered a class 1 laser device, safe for office/EDP use. The machine contains two GaAlAs laser diodes, 5-milliwatt, 760-800 nanometer wavelength for each emitter. Direct (or indirect reflected) eye contact with the laser beam might cause serious eye damage. Safety precautions and interlock mechanisms have been designed to prevent any possible laser beam exposure to the operator.

The following label is attached on the back side of the machine.

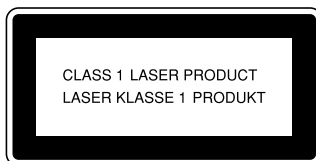

Warning:

Use of controls or adjustment or performance of procedures other than those specified in this manual might result in hazardous radiation exposure.

Notes:

The model names of the machines do not appear in the following pages. Check the type of your machine before reading this manual. (For details, see p.14 "Machine Types".)

- Type 1: DSm635
- Type 2: DSm645

Certain types might not be available in some countries. For details, please contact your local dealer.

Two kinds of size notation are employed in this manual. With this machine refer to the metric version.

For good copy quality, Rex-Rotary recommends that you use genuine Rex-Rotary toner.

Rex-Rotary shall not be responsible for any damage or expense that might result from the use of parts other than genuine Rex-Rotary parts in your Rex-Rotary office product.

Power Source

220 - 240V, 50/60Hz, 8A or more

Please be sure to connect the power cord to a power source as above. For details about power source, see p.142 "Power Connection".

Introduction

This manual describes detailed instructions on the operation and notes about the use of this machine. To get maximum versatility from this machine all operators are requested to read this manual carefully and follow the instructions. Please keep this manual in a handy place near the machine.

Important

Contents of this manual are subject to change without prior notice. In no event will the company be liable for direct, indirect, special, incidental, or consequential damages as a result of handling or operating the machine.

For safe and correct use of this machine, please be sure to read the Safety Information before you use it.

Notes:

Some illustrations in this manual might be slightly different from the machine.

Certain options might not be available in some countries. For details, please contact your local dealer.

Laser Safety:

This machine is considered a class 1 laser device, safe for office/EDP use. The machine contains two GaAlAs laser diodes, 5-milliwatt, 760-800 nanometer wavelength for each emitter. Direct (or indirect reflected) eye contact with the laser beam might cause serious eye damage. Safety precautions and interlock mechanisms have been designed to prevent any possible laser beam exposure to the operator.

The following label is attached on the back side of the machine.



Warning:

Use of controls or adjustment or performance of procedures other than those specified in this manual might result in hazardous radiation exposure.

Notes:

The model names of the machines do not appear in the following pages. Check the type of your machine before reading this manual. (For details, see p.14 "Machine Types".)

- Type 1: DSm635
- Type 2: DSm645

Certain types might not be available in some countries. For details, please contact your local dealer.

Two kinds of size notation are employed in this manual. With this machine refer to the metric version.

For good copy quality, Gestetner recommends that you use genuine Gestetner toner.

Gestetner shall not be responsible for any damage or expense that might result from the use of parts other than genuine Gestetner parts in your Gestetner office product.

Power Source

220 - 240V, 50/60Hz, 8A or more

Please be sure to connect the power cord to a power source as above. For details about power source, see p.142 "Power Connection".

Introduction

This manual describes detailed instructions on the operation and notes about the use of this machine. To get maximum versatility from this machine all operators are requested to read this manual carefully and follow the instructions. Please keep this manual in a handy place near the machine.

Important

Contents of this manual are subject to change without prior notice. In no event will the company be liable for direct, indirect, special, incidental, or consequential damages as a result of handling or operating the machine.

For safe and correct use of this machine, please be sure to read the Safety Information before you use it.

Notes:

Some illustrations in this manual might be slightly different from the machine.

Certain options might not be available in some countries. For details, please contact your local dealer.

Laser Safety:

This machine is considered a class 1 laser device, safe for office/EDP use. The machine contains two GaAlAs laser diodes, 5-milliwatt, 760-800 nanometer wavelength for each emitter. Direct (or indirect reflected) eye contact with the laser beam might cause serious eye damage. Safety precautions and interlock mechanisms have been designed to prevent any possible laser beam exposure to the operator.

The following label is attached on the back side of the machine.

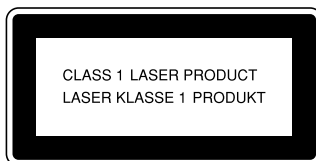

Warning:

Use of controls or adjustment or performance of procedures other than those specified in this manual might result in hazardous radiation exposure.

Notes:

The model names of the machines do not appear in the following pages. Check the type of your machine before reading this manual. (For details, see p.14 "Machine Types".)

- Type 1: DSm635
- Type 2: DSm645

Certain types might not be available in some countries. For details, please contact your local dealer.

Two kinds of size notation are employed in this manual. With this machine refer to the metric version.

For good copy quality, Nashuatec recommends that you use genuine Nashuatec toner.

Nashuatec shall not be responsible for any damage or expense that might result from the use of parts other than genuine Nashuatec parts in your Nashuatec office product.

Power Source

220 - 240V, 50/60Hz, 8A or more

Please be sure to connect the power cord to a power source as above. For details about power source, see p.142 "Power Connection".



Declaration of Conformity

“The Product complies with the requirements of the EMC Directive 89/336/EEC and its amending directives and the Low Voltage Directive 73/23/EEC and its amending directives.”

In accordance with IEC 60417, this machine uses the following symbols for the main power switch:

I means **POWER ON.**

⏻ means **STAND BY.**

Introduction

This manual describes detailed instructions on the operation and notes about the use of this machine. To get maximum versatility from this machine all operators are requested to read this manual carefully and follow the instructions. Please keep this manual in a handy place near the machine.

Important

Contents of this manual are subject to change without prior notice. In no event will the company be liable for direct, indirect, special, incidental, or consequential damages as a result of handling or operating the machine.

For safe and correct use of this machine, please be sure to read the Safety Information before you use it.

Notes:

Some illustrations in this manual might be slightly different from the machine.

Certain options might not be available in some countries. For details, please contact your local dealer.

Laser Safety:

This machine is considered a class 1 laser device, safe for office/EDP use. The machine contains two GaAlAs laser diodes, 5-milliwatt, 760-800 nanometer wavelength for each emitter. Direct (or indirect reflected) eye contact with the laser beam might cause serious eye damage. Safety precautions and interlock mechanisms have been designed to prevent any possible laser beam exposure to the operator.

The following label is attached on the back side of the machine.

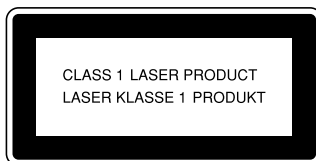

Warning:

Use of controls or adjustment or performance of procedures other than those specified in this manual might result in hazardous radiation exposure.

Notes:

The model names of the machines do not appear in the following pages. Check the type of your machine before reading this manual. (For details, see p.14 "Machine Types".)

- Type 1: IS 2135
- Type 2: IS 2145

Certain types might not be available in some countries. For details, please contact your local dealer.

Two kinds of size notation are employed in this manual. With this machine refer to the metric version.

For good copy quality, Infotec recommends that you use genuine Infotec toner.

Infotec shall not be responsible for any damage or expense that might result from the use of parts other than genuine Infotec parts in your Infotec office product.

Power Source

220 - 240V, 50/60Hz, 8A or more

Please be sure to connect the power cord to a power source as above. For details about power source, see p.142 "Power Connection".

This information is based on our present state of knowledge and is intended to provide general notes on our products and their uses.

It should not therefore be construed as guaranteeing specific properties of the products described or their suitability for particular applications.

Any existing industrial property rights must be observed. The quality of our products is guaranteed under our General Conditions of Sale.

M010.eps



Declaration of Conformity

“The Product complies with the requirements of the EMC Directive 89/336/EEC and its amending directives and the Low Voltage Directive 73/23/EEC and its amending directives.”

In accordance with IEC 60417, this machine uses the following symbols for the main power switch:

I means **POWER ON.**

⏻ means **STAND BY.**

Manuals for This Machine

The following manuals describe the operational procedures of this machine. For particular functions, see the relevant parts of the manual.

Note

- r Manuals provided are specific to machine type.
- r Adobe Acrobat Reader is necessary to view the manuals as a PDF file.
- r Two CD-ROMs are provided:
 - CD-ROM 1 "Operating Instructions for Printer/Scanner"
 - CD-ROM 2 "Scanner Driver & Document Management Utilities"
- v **General Settings Guide (this manual)**
Provides an overview of the machine and describes System Settings (paper trays, Key Operator Tools, etc.), Document Server functions, and troubleshooting.
Refer to this manual for Address Book procedures such as registering fax numbers, e-mail addresses, and user codes.
- v **Network Guide (PDF file - CD-ROM1)**
Describes procedures for configuring the machine and computers in a network environment.
- v **Copy Reference**
Describes operations, functions, and troubleshooting for the machine's copier function.
- v **Facsimile Reference <Basic Features>**
Describes operations, functions, and troubleshooting for the machine's facsimile function.
- v **Facsimile Reference <Advanced Features>**
Describes advanced functions and settings for key operators.
- v **Printer Reference 1**
Describes system settings and operations for the machine's printer function.
- v **Printer Reference 2 (PDF file - CD-ROM1)**
Describes operations, functions, and troubleshooting for the machine's printer function.
- v **Scanner Reference (PDF file - CD-ROM1)**
Describes operations, functions, and troubleshooting for the machine's scanner function.

v **Manuals for DeskTopBinder V2 Lite**

DeskTopBinder V2 Lite is a utility included on the CD-ROM labeled "Scanner Driver & Document Management Utilities".

- **DeskTopBinder V2 Lite Setup Guide (PDF file - CD-ROM2)**
Describes installation of, and the operating environment for DeskTopBinder V2 Lite in detail. This guide can be displayed from the **[Setup]** dialog box when DeskTopBinder V2 Lite is installed.
- **DeskTopBinder V2 Lite Introduction Guide (PDF file - CD-ROM2)**
Describes operations of DeskTopBinder V2 Lite and provides an overview of its functions. This guide is added to the **[Start]** menu when DeskTopBinder V2 Lite is installed.
- **Auto Document Link Guide (PDF file - CD-ROM2)**
Describes operations and functions of Auto Document Link installed with DeskTopBinder V2 Lite. This guide is added to the **[Start]** menu when DeskTopBinder V2 Lite is installed.

v **Manuals for ScanRouter V2 Lite**

ScanRouter V2 Lite is a utility included on the CD-ROM labeled "Scanner Driver & Document Management Utilities".

- **ScanRouter V2 Lite Setup Guide (PDF file - CD-ROM2)**
Describes installation of, settings, and the operating environment for ScanRouter V2 Lite in detail. This guide can be displayed from the **[Setup]** dialog box when ScanRouter V2 Lite is installed.
- **ScanRouter V2 Lite Management Guide (PDF file - CD-ROM2)**
Describes delivery server management and operations, and provides an overview of ScanRouter V2 Lite functions. This guide is added to the **[Start]** menu when ScanRouter V2 Lite is installed.

v **Other manuals**

- **PS3 Supplement (PDF file - CD-ROM1)**
- **Unix Supplement (available from an authorized dealer, or as a PDF file on our Web site)**

What You Can Do with This Machine

The following introduces the functions of this machine, and the relevant manuals containing detailed information about them.

Products marked with * are optional. For details about optional products, see p.18 “Options”, or contact your local dealer.

Copier, Facsimile, Printer, and Scanner Functions

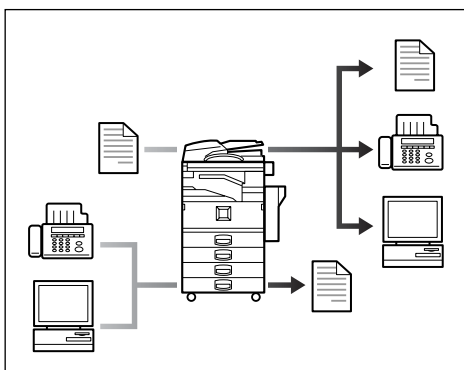

This machine provides copier, facsimile*, printer*, and scanner* functions.

- You can make copies of originals. With a finisher*, you can sort and staple copies. See *Copy Reference*.
- You can send originals by fax or e-mail, and receive faxes from other parties. See *Facsimile Reference <Basic Features>*, and *Facsimile Reference <Advanced Features>*.
- You can print documents created in computer applications. See *Printer Reference 1*, and *Printer Reference 2*.
- You can scan originals and send scan files to a computer. See *Scanner Reference*.

Utilizing Stored Documents

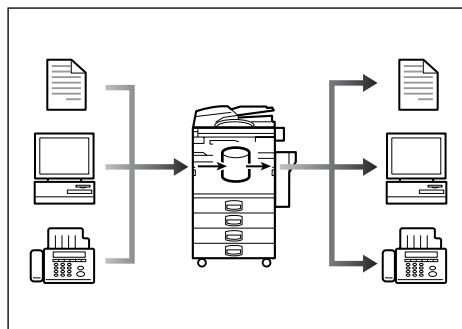

- You can store files scanned by this machine, or files sent from other fax machine or computers, into the machine's hard disk. You can print and fax stored files as required. You can also change print settings and print multiple documents (Document Server). See p.35 “Using the Document Server”.
- With DeskTopBinder V2 Professional*/Lite, you can search, check, print, and delete stored documents using your computer. You can also retrieve stored documents scanned in scanner mode. With file format converter*, you can even download documents stored in copy and printer functions to your computer. See *Network Guide* and *Scanner Reference*.

Paperless Fax Transmission and Reception

Reception

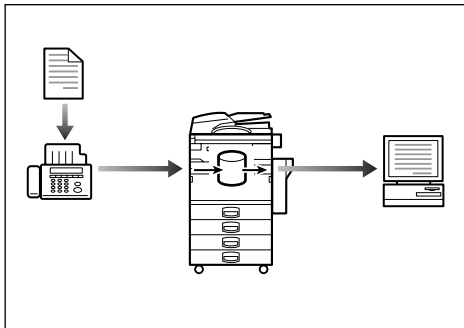

- You can store received fax messages on the machine's hard disk, instead of printing them onto paper. You can use DeskTopBinder V2 Professional*/Lite or a Web browser to check, print, delete, retrieve, or download documents using your computer (Storing received documents). See *Facsimile Reference* <Advanced Features>.

Transmission

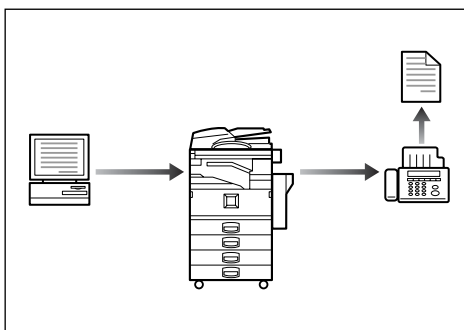

- You can send documents created in computer applications to another party's fax machine directly, without performing a print job (LAN-Fax). See *Facsimile Reference* <Advanced Features>.

Fax Transmission and Reception Through the Internet

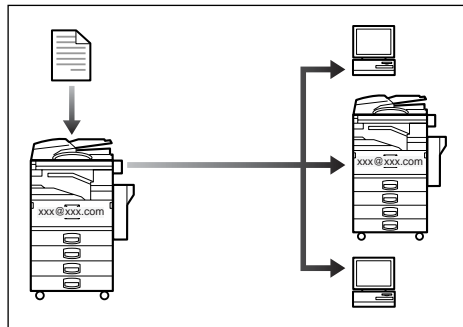

- You can send fax documents through e-mail by specifying the recipient's e-mail address (Internet Fax Transmission). You can receive sent documents via Internet Fax, or from computers (Internet Fax Reception). See *Facsimile Reference* <Basic Features>.

Using the Scanner in a Network Environment

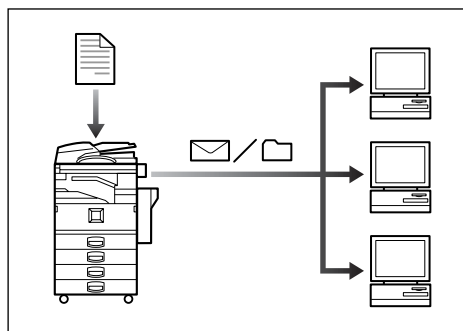

- You can send scan files to a specified destination using e-mail (Sending scan file by e-mail). See *Scanner Reference*.

- With ScscanRouter V2 Professional*/Lite, you can save scan files in specified destinations on network computers (Using the network delivery scanner function). See *Scanner Reference*.
- You can send scan files directly to folders (Sending scan file by Scan to Folder). See *Scanner Reference*.

Administering the Machine/ Protecting Documents (Security Functions)

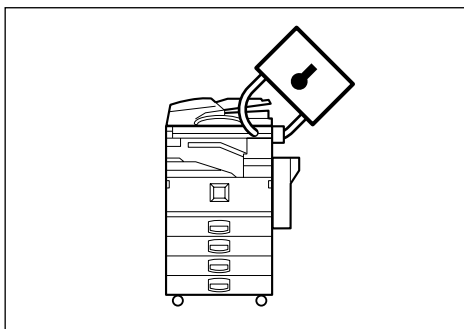

The security functions protect documents from being copied without permission or unauthorized access via the network. See p.149 “Security”.

v Security Functions

- Protecting stored documents (setting passwords)
- Protecting data remaining in memory
- Protecting against unauthorized access via phone lines
- Authenticating administrator (setting the key operator code). See p.60 “Key Operator Code”.

v Extended Security Function

By setting a password, documents are protected against unauthorized access. See p.60 “Extended Security”.

Monitoring the Machine Via Computer

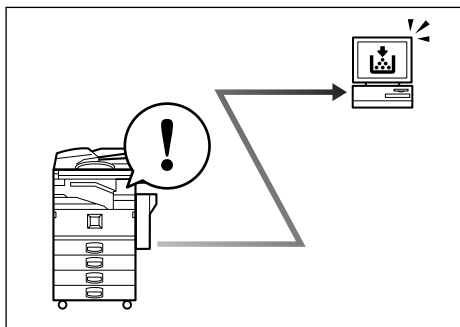

You can monitor machine status and change settings using a computer.

- Using SmartNetMonitor for Admin, SmartNetMonitor for Client, or a Web browser, you can use a computer to view the machine's status, such as to check on paper quantities, or misfeeds, etc. See *Network Guide*.
- You can use a Web browser to make network settings. See *Network Guide*.
- You can also use a Web browser to register and manage items such as user codes, fax numbers, e-mail addresses, and folders in the Address Book. See the Web browser's Help.

TABLE OF CONTENTS

Manuals for This Machine	i
What You Can Do with This Machine	iii
Copier, Facsimile, Printer, and Scanner Functions	iii
Utilizing Stored Documents	iii
Paperless Fax Transmission and Reception	iv
Fax Transmission and Reception Through the Internet	iv
Using the Scanner in a Network Environment	iv
Administrating the Machine/ Protecting Documents (Security Functions)	v
Monitoring the Machine Via Computer	v
Notice	1
Copyrights and Trademarks	2
Trademarks	2
Information about Installed Software	3
How to Read This Manual	8
Safety Information	9
Safety During Operation	9
Positions of ⚠WARNING and ⚠CAUTION labels	11
ENERGY STAR Program	12
Machine Types	14
 1. Getting Started	
<hr/>	
Guide to Components	15
Options	18
External Options	18
Internal Options	19
Control Panel	20
Display Panel	22
Turning On the Power	23
Turning On the Main Power	23
Turning On the Power	24
Turning Off the Power	24
Turning Off the Main Power	24
Saving Energy	25
 2. Combined Function Operations	
<hr/>	
Changing Modes	27
Multi-Access	29

3. Document Server





Relationship between the Document Server and Other Functions	33
Document Server Display	34
Using the Document Server	35
Storing Data	35
Changing Stored Document's File Name, User Name, or Password.....	38
Selecting a Document.....	38
Searching for Stored Documents	39
Printing Stored Documents	40
Deleting Stored Documents	43
Viewing Stored Documents Using a Web Browser	43
Downloading Stored Documents.....	44
Settings for the Document Server	45

4. User Tools (System Settings)

User Tools Menu (System Settings)	47
Accessing User Tools (System Settings)	50
Changing Default Settings	50
Quitting User Tools	50
Settings You Can Change with User Tools	51
General Features	51
Tray Paper Settings	55
Timer Settings.....	58
Key Operator Tools	59
Address Book	67
Registering Destination Information	68
Registering Sender Information	69
User Code	70
Registering a New User Code.....	70
Changing a User Code.....	72
Deleting a User Code.....	73
Displaying the Number of Prints for Each User Code	73
Printing the Number of Prints for Each User Code	74
Clearing the Number of Prints.....	75
Fax Destination	76
Registering a Fax Destination	77
Changing a Registered Fax Destination	79
Deleting a Registered Fax Destination.....	81
E-mail Destination	82
Registering an E-mail Destination.....	82
Changing a Registered E-mail Destination	84
Deleting a Registered E-mail Destination	84
Registering Folders	85
Using SMB to Connect.....	85
Using FTP to Connect.....	89
Registering a Protection Code	93
Registering a Protection Code To a Single User	93
Registering a Protection Code To a Group User	94

Registering Destinations to a Group	95
Registering a New Group	95
Registering Destinations to a Group	96
Removing a Destination from a Group	96
Displaying Destinations Registered in Groups	96
Changing a Group Name	97
Deleting a Group	97
Registering the Transfer Request	98
Registering a Transfer Station/Receiving Station	98
Changing a Registered Transfer Station/Receiving Station	100
Deleting a Registered Transfer Station/Receiving Station	101
Programming/Changing LDAP Server	102
Programming an LDAP Server	102
Changing an LDAP Server	104

5. Troubleshooting

If Your Machine Does Not Operate As You Want	107
General	107
Document Server	109
 Loading Paper	110
Loading Paper into Paper Trays	110
Loading Paper into Large Capacity Tray (optional)	110
 Adding Toner	113
Removing Toner	114
Inserting Toner	115
 Clearing Misfeeds	116
Changing the Paper Size	126
Changing the Paper Size of the Paper Tray	126
 Adding Staples	129
1000-Sheet Finisher	129
2 Tray Finisher	130
Booklet Finisher	132
Removing Jammed Staples	134
1000-Sheet Finisher	134
2 Tray Finisher	135
Booklet Finisher	136
 Removing Punch Waste	138

6. Remarks

Dos and Don'ts	139
Toner	140
Handling Toner	140
Toner Storage	140
Used Toner	140
Where to Put Your Machine	141
Machine Environment	141
Moving	141
Power Connection	142
Access to the Machine	142

Maintaining Your Machine	143
Cleaning the Exposure Glass.....	143
Cleaning the Exposure Glass Cover	143
Cleaning the Auto Document Feeder.....	143
Changing the Photoconductor Unit (PCU)	144
Other Functions	145
Inquiry	145
Changing the Language.....	145
Counter	146
Displaying the Total Counter.....	146
7. Entering Text	
<hr/>	
Entering Text.....	147
Available Characters	147
Keys	147
How to Enter Text	148
8. Security	
<hr/>	
Security.....	149
Primary Security Functions	149
Extended Security Function	149
Temporarily Disabling Document Security	151
Operating Environment and Notes.....	152
Operating Environment	152
For Administrator.....	152
For User	153
9. Specifications	
<hr/>	
Main unit.....	155
Options	159
Exposure Glass Cover	159
Auto Document Feeder	159
1000-Sheet Finisher.....	160
2 Tray Finisher	161
Punch Kit.....	162
Booklet Finisher	163
Bridge Unit	164
Internal Tray 2 (1 bin tray).....	165
Large Capacity Tray.....	165
Paper Tray Unit.....	166
Copy Paper.....	167
Recommended Paper Sizes and Types.....	167
Unusable Paper	169
Paper Storage.....	170
INDEX.....	171

Notice

Notice To Wireless LAN Interface (optional) Users



Notice to Users in EEA Countries

This product complies with the essential requirements and provisions of Directive 1999/5/EC of the European Parliament and of the Council of 9 March 1999 on radio equipment and telecommunications terminal equipment and the mutual recognition of their conformity.

The CE Declaration of Conformity is available on the Internet at URL:

http://www.ricoh.co.jp/fax/ce_doc/.

This product is only for use in EEA or other authorized countries. Outdoor use of this product in Belgium, France, Germany, Italy, or the Netherlands is prohibited.

Copyrights and Trademarks

Trademarks

Microsoft[®], Windows[®] and Windows NT[®] are registered trademarks of Microsoft Corporation in the United States and/or other countries.

Acrobat[®] is a registered trademark of Adobe Systems Incorporated.

Bluetooth[™] is a trademark of the Bluetooth SIG, Inc. (Special Interest Group) and is used by RICOH Company Limited under license.

Copyright ©2001 Bluetooth SIG, Inc.

The Bluetooth Trademarks are owned by Bluetooth SIG, Inc. USA

Other product names used herein are for identification purposes only and might be trademarks of their respective companies. We disclaim any and all right in those marks.

The proper names of the Windows operating systems are as follows:

- The product name of Windows[®] 95 is Microsoft[®] Windows[®] 95
- The product name of Windows[®] 98 is Microsoft[®] Windows[®] 98
- The product name of Windows[®] Me is Microsoft[®] Windows[®] Millennium Edition (Windows Me)
- The product names of Windows[®] 2000 are as follows:
Microsoft[®] Windows[®] 2000 Advanced Server
Microsoft[®] Windows[®] 2000 Server
Microsoft[®] Windows[®] 2000 Professional
- The product names of Windows[®] XP are as follows:
Microsoft[®] Windows[®] XP Professional
Microsoft[®] Windows[®] XP Home Edition
- The product names of Windows Server[™] 2003 are as follows:
Microsoft[®] Windows Server[™] 2003 Standard Edition
Microsoft[®] Windows Server[™] 2003 Enterprise Edition
Microsoft[®] Windows Server[™] 2003 Web Edition
- The product names of Windows[®] NT are as follows:
Microsoft[®] Windows NT[®] Server 4.0
Microsoft[®] Windows NT[®] Workstation 4.0

Information about Installed Software

expat

- The software including controller, etc. (hereinafter "software") installed on this product uses the expat Version 1.95.2 (hereinafter "expat") under the conditions mentioned below.

- The product manufacturer provides warranty and support to the software of the product including the expat, and the product manufacturer makes the initial developer and copyright holder of the expat, free from these obligations.
- Information relating to the expat is available at:
<http://expat.sourceforge.net/>

Copyright (c) 1998, 1999, 2000 Thai Open Source Software Centre, Ltd. and Clark Cooper.

Permission is hereby granted, free of charge, to any person obtaining a copy of this software and associated documentation files (the "Software"), to deal in the Software without restriction, including without limitation the rights to use, copy, modify, merge, publish, distribute, sublicense, and/or sell copies of the Software, and to permit persons to whom the Software is furnished to do so, subject to the following conditions:

The above copyright notice and this permission notice shall be included in all copies or substantial portions of the Software.

THE SOFTWARE IS PROVIDED "AS IS", WITHOUT WARRANTY OF ANY KIND, EXPRESS OR IMPLIED, INCLUDING BUT NOT LIMITED TO THE WARRANTIES OF MERCHANTABILITY, FITNESS FOR A PARTICULAR PURPOSE AND NONINFRINGEMENT. IN NO EVENT SHALL THE AUTHORS OR COPYRIGHT HOLDERS BE LIABLE FOR ANY CLAIM, DAMAGES OR OTHER LIABILITY, WHETHER IN AN ACTION OF CONTRACT, TORT OR OTHERWISE, ARISING FROM, OUT OF OR IN CONNECTION WITH THE SOFTWARE OR THE USE OR OTHER DEALINGS IN THE SOFTWARE.

NetBSD

1. Copyright Notice of NetBSD

For all users to use this product:

This product contains NetBSD operating system:

For the most part, the software constituting the NetBSD operating system is not in the public domain; its authors retain their copyright.

The following text shows the copyright notice used for many of the NetBSD source code. For exact copyright notice applicable for each of the files/binaries, the source code tree must be consulted.

A full source code can be found at <http://www.netbsd.org/>.

Copyright © 1999, 2000 The NetBSD Foundation, Inc.

All rights reserved.

Redistribution and use in source and binary forms, with or without modification, are permitted provided that the following conditions are met:

- ① Redistributions of source code must retain the above copyright notice, this list of conditions and the following disclaimer.
- ② Redistributions in binary form must reproduce the above copyright notice, this list of conditions and the following disclaimer in the documentation and/or other materials provided with the distribution.

- ③ All advertising materials mentioning features or use of this software must display the following acknowledgment:
This product includes software developed by The NetBSD Foundation, Inc. and its contributors.
- ④ Neither the name of The NetBSD Foundation nor the names of its contributors may be used to endorse or promote products derived from this software without specific prior written permission.

THIS SOFTWARE IS PROVIDED BY THE NETBSD FOUNDATION, INC. AND CONTRIBUTORS "AS IS" AND ANY EXPRESS OR IMPLIED WARRANTIES, INCLUDING, BUT NOT LIMITED TO, THE IMPLIED WARRANTIES OF MERCHANTABILITY AND FITNESS FOR A PARTICULAR PURPOSE ARE DISCLAIMED. IN NO EVENT SHALL THE FOUNDATION OR CONTRIBUTORS BE LIABLE FOR ANY DIRECT, INDIRECT, INCIDENTAL, SPECIAL, EXEMPLARY, OR CONSEQUENTIAL DAMAGES (INCLUDING, BUT NOT LIMITED TO, PROCUREMENT OF SUBSTITUTE GOODS OR SERVICES; LOSS OF USE, DATA, OR PROFITS; OR BUSINESS INTERRUPTION) HOWEVER CAUSED AND ON ANY THEORY OF LIABILITY, WHETHER IN CONTRACT, STRICT LIABILITY, OR TORT (INCLUDING NEGLIGENCE OR OTHERWISE) ARISING IN ANY WAY OUT OF THE USE OF THIS SOFTWARE, EVEN IF ADVISED OF THE POSSIBILITY OF SUCH DAMAGE.

2. Sablotron

Sablotron (Version 0.82) Copyright (c) 2000 Ginger Alliance Ltd. All Rights Reserved

- a) The application software installed on this product includes the Sablotron software Version 0.82 (hereinafter, "Sablotron 0.82"), with modifications made by the product manufacturer. The original code of the Sablotron 0.82 is provided by Ginger Alliance Ltd., the initial developer, and the modified code of the Sablotron 0.82 has been derived from such original code provided by Ginger Alliance Ltd.
- b) The product manufacturer provides warranty and support to the application software of this product including the Sablotron 0.82 as modified, and the product manufacturer makes Ginger Alliance Ltd., the initial developer of the Sablotron 0.82, free from these obligations.
- c) The Sablotron 0.82 and the modifications thereof are made available under the terms of Mozilla Public License Version 1.1 (hereinafter, "MPL 1.1"), and the application software of this product constitutes the "Larger Work" as defined in MPL 1.1. The application software of this product except for the Sablotron 0.82 as modified is licensed by the product manufacturer under separate agreement(s).
- d) The source code of the modified code of the Sablotron 0.82 is available at: <http://support-download.com/services/device/sablot/notice082.html>
- e) The source code of the Sablotron software is available at: <http://www.ginger-all.com>
- f) MPL 1.1 is available at: <http://www.mozilla.org/MPL/MPL-1.1.html>

3. Authors Name List

All product names mentioned herein are trademarks of their respective owners.

The following notices are required to satisfy the license terms of the software that we have mentioned in this document:

- This product includes software developed by the University of California, Berkeley and its contributors.
- This product includes software developed by Jonathan R. Stone for the NetBSD Project.
- This product includes software developed by the NetBSD Foundation, Inc. and its contributors.
- This product includes software developed by Manuel Bouyer.
- This product includes software developed by Charles Hannum.
- This product includes software developed by Charles M. Hannum.
- This product includes software developed by Christopher G. Demetriou.
- This product includes software developed by Tools GmbH.
- This product includes software developed by Terrence R. Lambert.
- This product includes software developed by Adam Glass and Charles Hannum.
- This product includes software developed by Theo de Raadt.
- This product includes software developed by Jonathan Stone and Jason R. Thorpe for the NetBSD Project.
- This product includes software developed by the University of California, Lawrence Berkeley Laboratory and its contributors.
- This product includes software developed by Christos Zoulas.
- This product includes software developed by Christopher G. Demetriou for the NetBSD Project.
- This product includes software developed by Paul Kranenburg.
- This product includes software developed by Adam Glass.
- This product includes software developed by Jonathan Stone.
- This product includes software developed by Jonathan Stone for the NetBSD Project.
- This product includes software developed by Winning Strategies, Inc.
- This product includes software developed by Frank van der Linden for the NetBSD Project.
- This product includes software developed for the NetBSD Project by Frank van der Linden
- This product includes software developed for the NetBSD Project by Jason R. Thorpe.
- The software was developed by the University of California, Berkeley.
- This product includes software developed by Chris Provenzano, the University of California, Berkeley, and contributors.

JPEG LIBRARY

- The software installed on this product is based in part on the work of the Independent JPEG Group.

SASL

CMU libsasl

Tim Martin

Rob Earhart

Rob Siemborski

Copyright (c) 2001 Carnegie Mellon University. All rights reserved.

Redistribution and use in source and binary forms, with or without modification, are permitted provided that the following conditions are met:

- ① Redistributions of source code must retain the above copyright notice, this list of conditions and the following disclaimer.
- ② Redistributions in binary form must reproduce the above copyright notice, this list of conditions and the following disclaimer in the documentation and/or other materials provided with the distribution.
- ③ The name "Carnegie Mellon University" must not be used to endorse or promote products derived from this software without prior written permission. For permission or any other legal details, please contact:

Office of Technology Transfer
Carnegie Mellon University
5000 Forbes Avenue
Pittsburgh, PA 15213-3890
(412) 268-4387, fax: (412) 268-7395
tech-transfer@andrew.cmu.edu

- ④ Redistributions of any form whatsoever must retain the following acknowledgment:

"This product includes software developed by Computing Services at Carnegie Mellon University (<http://www.cmu.edu/computing/>)."

CARNEGIE MELLON UNIVERSITY DISCLAIMS ALL WARRANTIES WITH REGARD TO THIS SOFTWARE, INCLUDING ALL IMPLIED WARRANTIES OF MERCHANTABILITY AND FITNESS, IN NO EVENT SHALL CARNEGIE MELLON UNIVERSITY BE LIABLE FOR ANY SPECIAL, INDIRECT OR CONSEQUENTIAL DAMAGES OR ANY DAMAGES WHATSOEVER RESULTING FROM LOSS OF USE, DATA OR PROFITS, WHETHER IN AN ACTION OF CONTRACT, NEGLIGENCE OR OTHER TORTIOUS ACTION, ARISING OUT OF OR IN CONNECTION WITH THE USE OR PERFORMANCE OF THIS SOFTWARE.

MD4

Copyright (C) 1990-2, RSA Data Security, Inc. All rights reserved.

License to copy and use this software is granted provided that it is identified as the "RSA Data Security, Inc. MD4 Message-Digest Algorithm" in all material mentioning or referencing this software or this function.

License is also granted to make and use derivative works provided that such works are identified as "derived from the RSA Data Security, Inc. MD4 Message-Digest Algorithm" in all material mentioning or referencing the derived work.

RSA Data Security, Inc. makes no representations concerning either the merchantability of this software or the suitability of this software for any particular purpose. It is provided "as is" without express or implied warranty of any kind.

These notices must be retained in any copies of any part of this documentation and/or software.

MD5

Copyright (C) 1991-2, RSA Data Security, Inc. Created 1991. All rights reserved.

License to copy and use this software is granted provided that it is identified as the "RSA Data Security, Inc. MD5 Message-Digest Algorithm" in all material mentioning or referencing this software or this function.

License is also granted to make and use derivative works provided that such works are identified as "derived from the RSA Data Security, Inc. MD5 Message-Digest Algorithm" in all material mentioning or referencing the derived work.

RSA Data Security, Inc. makes no representations concerning either the merchantability of this software or the suitability of this software for any particular purpose. It is provided "as is" without express or implied warranty of any kind.

These notices must be retained in any copies of any part of this documentation and/or software.

How to Read This Manual

Symbols

The following set of symbols is used in this manual.

WARNING:

This symbol indicates a potentially hazardous situation that might result in death or serious injury when you misuse the machine without following the instructions under this symbol. Be sure to read the instructions, all of which are described in the Safety Information section.

CAUTION:

This symbol indicates a potentially hazardous situation that might result in minor or moderate injury or property damage that does not involve personal injury when you misuse the machine without following the instructions under this symbol. Be sure to read the instructions, all of which are described in the Safety Information section.

* The statements above are notes for your safety.

Important

If this instruction is not followed, paper might be misfed, originals might be damaged, or data might be lost. Be sure to read this.

Preparation

This symbol indicates information or preparations required prior to operating.

Note

This symbol indicates precautions for operation, or actions to take after abnormal operation.

Limitation

This symbol indicates numerical limits, functions that cannot be used together, or conditions in which a particular function cannot be used.

Reference

This symbol indicates a reference.

[]

Keys that appear on the machine's display panel.

[]

Keys built into the machine's control panel.

Safety Information

When using this machine, the following safety precautions should always be followed.

Safety During Operation

In this manual, the following important symbols are used:

⚠ WARNING:
Indicates a potentially hazardous situation which, if instructions are not followed, could result in death or serious injury.

⚠ CAUTION:
Indicates a potentially hazardous situation which, if instructions are not followed, may result in minor or moderate injury or damage to property.

⚠ WARNING:

- **Connect the power cord directly into a wall outlet and never use an extension cord.**
- **Disconnect the power plug (by pulling the plug, not the cable) if the power cable or plug becomes frayed or otherwise damaged.**
- **To avoid hazardous electric shock or laser radiation exposure, do not remove any covers or screws other than those specified in this manual.**
- **Turn off the power and disconnect the power plug (by pulling the plug, not the cable) if any of the following occurs:**
 - **You spill something into the machine.**
 - **You suspect that your machine needs service or repair.**
 - **The external housing of your machine has been damaged.**
- **Do not incinerate spilled toner or used toner. Toner dust might ignite when exposed to an open flame.**
- **Disposal can take place at our authorized dealer.**
- **Dispose of the used toner bottle in accordance with the local regulations.**

⚠ CAUTION:

- *Protect the machine from dampness or wet weather, such as rain and snow.*
- *Unplug the power cord from the wall outlet before you move the machine. While moving the machine, you should take care that the power cord will not be damaged under the machine.*
- *When you disconnect the power plug from the wall outlet, always pull the plug (not the cable).*
- *Do not allow paper clips, staples, or other small metallic objects to fall inside the machine.*
- *Keep toner (used or unused) and toner bottle out of the reach of children.*
- *For environmental reasons, do not dispose of the machine or expended supply waste at household waste collection points. Disposal can take place at an authorized dealer.*
- *The inside of the machine could be very hot. Do not touch the parts with a label indicating the "hot surface". Otherwise, an injury might occur.*

Positions of ⚠️WARNING and ⚠️CAUTION labels

This machine has labels for ⚠️WARNING and ⚠️CAUTION at the positions shown below. For safety, please follow the instructions and handle the machine as indicated.

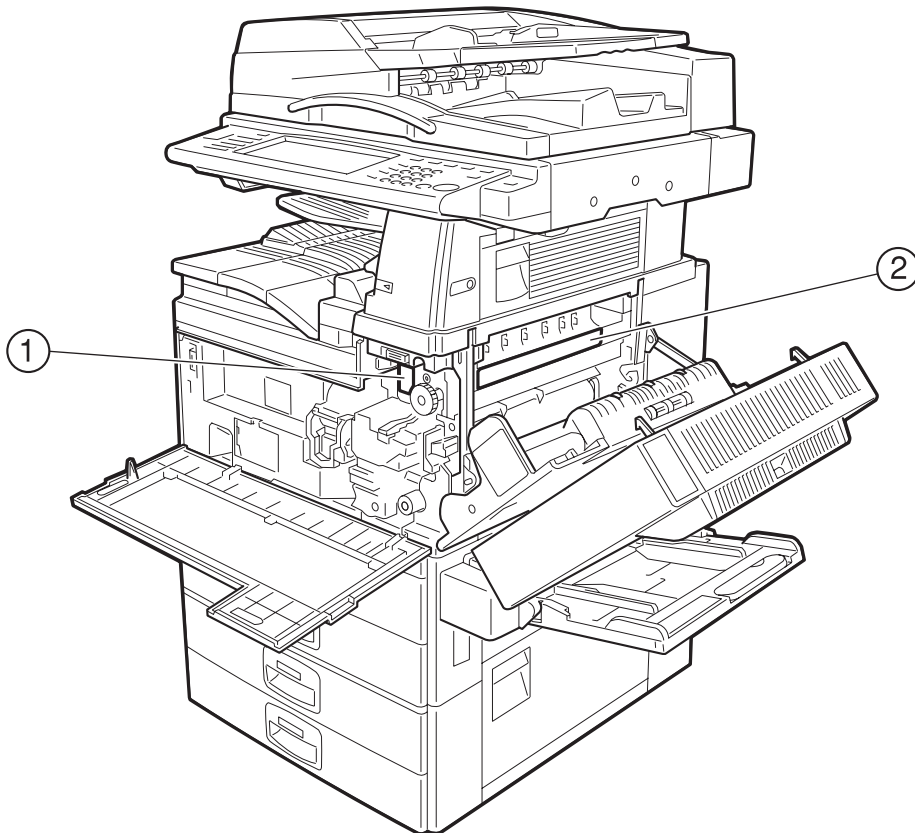

②

<p>CAUTION ATTENTION 注意 ACHTUNG ATTENZIONE PRECAUCIÓN</p>		<ul style="list-style-type: none"> • High temperature. Be careful of hot parts when clearing paper jams. • Temperature leve. Attention aux pices chaudes en supprimant un bourrage papier. • Vorsicht hohe Temperaturen! Achten Sie auf heisse Gerteteile, wenn Sie einen Papierstau beheben. 	<ul style="list-style-type: none"> • Temperatura elevata. Fare attenzione alle parti calde quando si eliminano gli inceppamenti della carta. • Alta temperatura. Tenga cuidado con las partes calientes cuando elimine los atascamientos de papel. • 高温です。用紙つまり処理は、高温部分に注意しながら行ってください。 >P.ET<
---	--	--	--

ENERGY STAR Program

<p>ENERGY STAR®</p>  <hr data-bbox="192 492 528 502"/>	<p>As an ENERGY STAR Partner, we have determined that this machine model meets the ENERGY STAR Guidelines for energy efficiency.</p>
---	--

The ENERGY STAR Guidelines intend to establish an international energy-saving system for developing and introducing energy-efficient office equipment to deal with environmental issues, such as global warming.

When a product meets the ENERGY STAR Guidelines for energy efficiency, the Partner shall place the ENERGY STAR logo onto the machine model.

This product was designed to reduce the environmental impact associated with office equipment by means of energy-saving features, such as Low-power mode.

v Low-Power mode and Off mode or Sleep mode

This product automatically lowers its power consumption when it is not operated for a fixed time (standard setting time: 1 minute). This is called “Off mode” on a single function copying machine, and “Sleep mode” on a multiple function machine equipped with optional facsimile and printing functions.

- Off mode: Same as the condition when the operation switch is turned off.
- Sleep mode: Same as the condition when the operation switch is turned off. Receiving fax messages and printing from a computer are possible.

If you want to operate this product while it is in either of these modes, do one of the following:

- Turn on the operation switch.
- Place an original in the Auto Document Feeder (ADF).
- Lift and lower the exposure glass cover or the ADF.

The default interval before entering Off mode or Sleep mode can be adjusted. To change it, see p.58 “Auto Off Timer”.

The ENERGY STAR Program establishes two modes which lower the power consumption of the product when it is not operated for a fixed time. These modes are the Low-power mode and the Off mode or Sleep mode. This product has only one mode, the Off mode or Sleep mode. This mode meets the requirements of both the Low-power mode and Off mode or Sleep mode. In this manual, the Off mode is called the Auto Off mode.

v Duplex Priority

The ENERGY STAR Program recommends the duplex function. By conserving paper resources this function is less of a burden to the environment. For applicable machines, duplex function (one-sided originals→ two-sided copies) can be selected preferentially when the operation switch or the main power switch is turned on, the **[Energy Saver]** key is pressed, or the machine resets automatically.

Reference

To change the settings of the Duplex Priority mode, see “Duplex Mode Priority” in “General Features 2/4”, *Copy Reference*.

Specifications

		Copier only		Fax, printer and scanner installed	
		Type 1	Type 2	Type 1	Type 2
Low-power Mode, Off Mode	Power consumption	5 W	5 W	—	
	Default interval	1 minute		—	
	Recovery time	10 seconds or less	15 seconds or less	—	
Low-power mode, Sleep mode	Power consumption	—		9 W	9 W
	Default interval	—		1 minute	
	Recovery time	—		10 seconds or less	15 seconds or less
Duplex priority		One-sided→One-sided			

Recycled Paper

In accordance with the ENERGY STAR Program, we recommend use of recycled paper which is environmentally friendly. Please contact your sales representative for recommended paper.

Machine Types

This machine comes in two models which vary in copy speed. To ascertain which model you have, see the inside front cover.

	Type 1	Type 2
Copy speed	35 copies/minute (A4 □, 8 ¹ / ₂ " × 11" □)	45 copies/minute (A4 □, 8 ¹ / ₂ " × 11" □)

1. Getting Started

Guide to Components

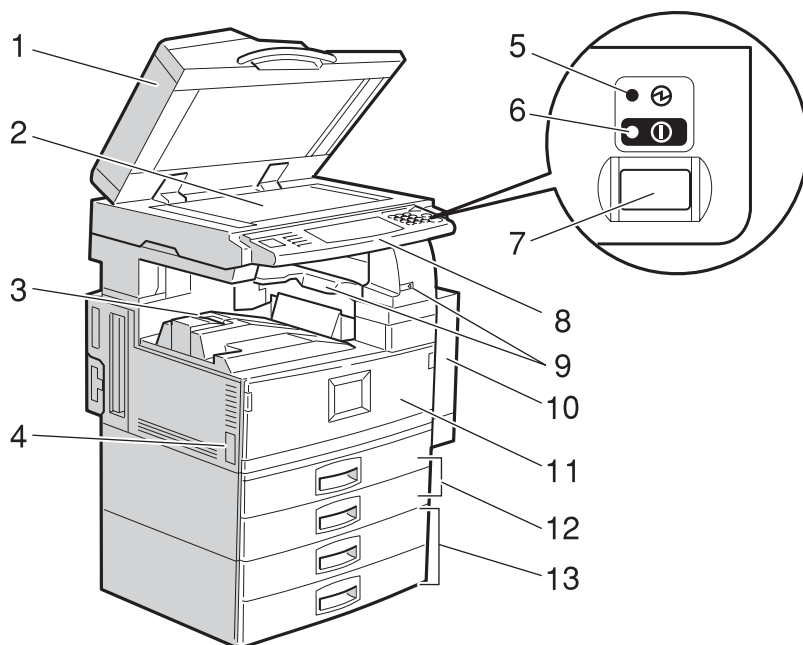

1. Exposure glass cover (optional) or Auto Document Feeder (ADF) (optional)

See p.18 “External Options”.

(The illustration shows the ADF.)

2. Exposure glass

Place originals face down here for copying.

3. Internal tray

Copied, printed paper or fax messages are delivered here.

4. Main power switch

If the machine does not operate after turning on the operation switch, check the main power switch is turned on. See p.23 “Turning On the Power”.

5. Main power indicator

Lights when the main power switch is turned on, and goes off when the switch is turned off.

6. On indicator

Lights when the operation switch is turned on, and goes off when the switch is turned off.

7. Operation switch

Press to turn the power on (the **On** indicator lights up). To turn the power off, press again (the **On** indicator goes off). See p.23 “Turning On the Power”.

8. Control panel

See p.20 “Control Panel”.

9. Internal tray 2 (1 bin tray) (optional)

The indicator lights when paper is delivered to internal tray 2 (1 bin tray). If internal tray 2 has not been installed, the indicator does not light. See p.18 “External Options”.

10. Duplex unit (unit for two-sided copies)

Allows you to print on both sides of a piece paper in copier and printer function.

11. Front cover

Open to access the inside of the machine.

12. Paper tray (upper: Tray 1, lower: Tray 2)

Load paper here.

13. Paper tray unit (optional <upper: Tray 3, lower: Tray 4>)

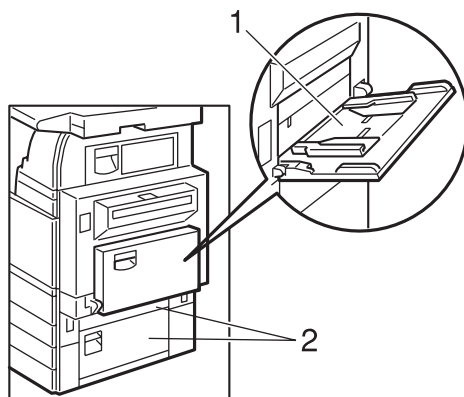

1. Bypass tray

Use when copying onto OHP transparencies, adhesive labels, translucent paper, postcards, and custom size paper.

2. Right side cover

Open this when a paper jam occurs.

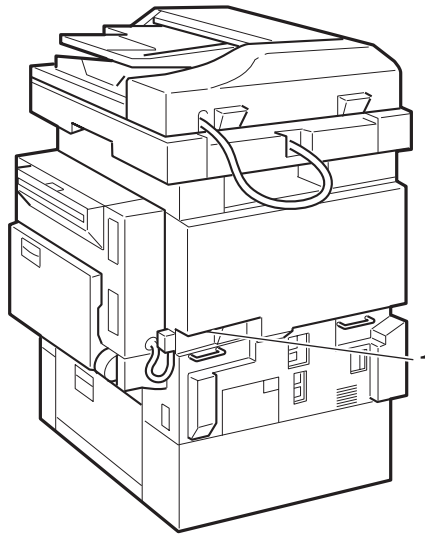

1

1. Ventilation holes

Prevent overheating. Do not obstruct the ventilation holes by placing objects near them or leaning things against them. If the machine overheats, a fault might occur.

Options

1

External Options

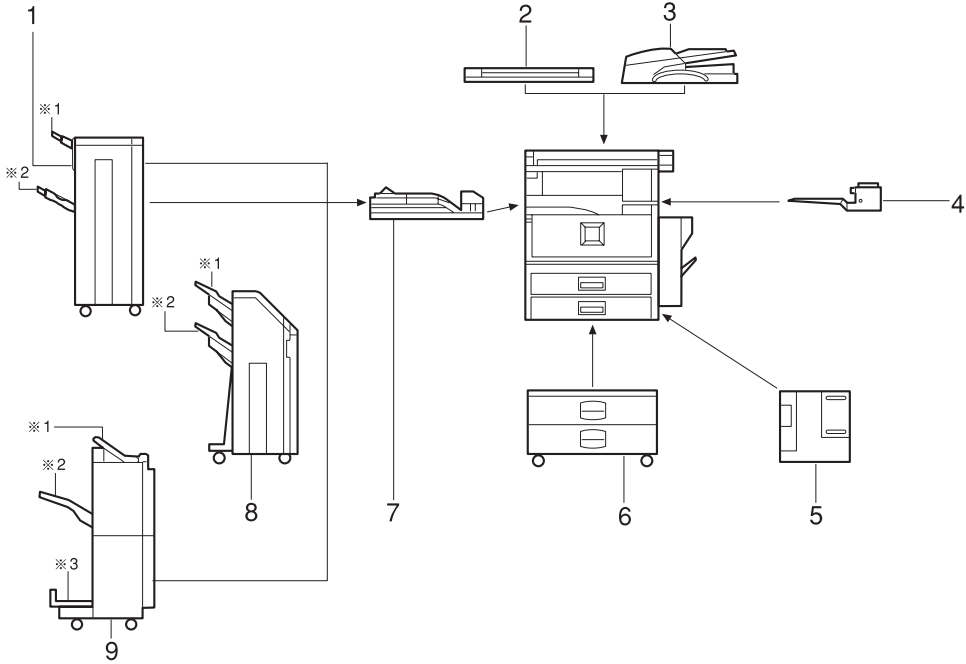

1. 1000-sheet finisher

Sorts, stacks, and staples copies.

*1: Finisher upper tray

*2: Finisher shift tray

2. Exposure glass cover

Lower over originals for copying.

3. Auto Document Feeder

Place stacks of originals here. They will feed in automatically.

4. Internal tray 2 (1 bin tray)

If you select this as the output tray, copied paper will be delivered here face down.

5. Large Capacity Tray (LCT)

Holds up to 1,500 sheets of paper.

6. Paper tray unit

Consists of two paper trays.

7. Bridge unit

Relays copies to the finisher.

8. 2 Tray finisher

Sorts, stacks, and staples copies. You can also punch copies. (The Punch function is optional.)

*1: Finisher shift tray 1

*2: Finisher shift tray 2

9. Booklet finisher

Sorts, stacks, and staples copies. The saddle stitch function can staple the copies in the centre and folds them like a booklet.

*1: Finisher upper tray

*2: Finisher shift tray

*3: Finisher booklet tray

Internal Options

- ① Fax unit
Allows you to use the facsimile function.
- ② Printer/Scanner unit
Allows you to use the printer and scanner functions.
- ③ User account enhance unit
Allows you to increase memory for storing user codes.
- ④ File format converter
Allows you to download documents stored using the copier and printer functions from the Document Server. See p.44 “Downloading Stored Documents”.
- ⑤ IEEE 1394 interface board
Allows you to connect to an IEEE 1394 cable.
- ⑥ IEEE 802.1b wireless LAN board
Allows you to install a wireless LAN interface.
- ⑦ Bluetooth unit
Allows you to expand the interface.
- ⑧ USB 2.0 interface board
Allows you to connect a variety of external devices.

 **Note**

- r You cannot install two or more of the options below: IEEE 1394 interface board, IEEE 802.1b wireless LAN board, Bluetooth unit, USB 2.0 interface board.

Control Panel

This illustration shows the control panel of the machine with options fully installed.

1

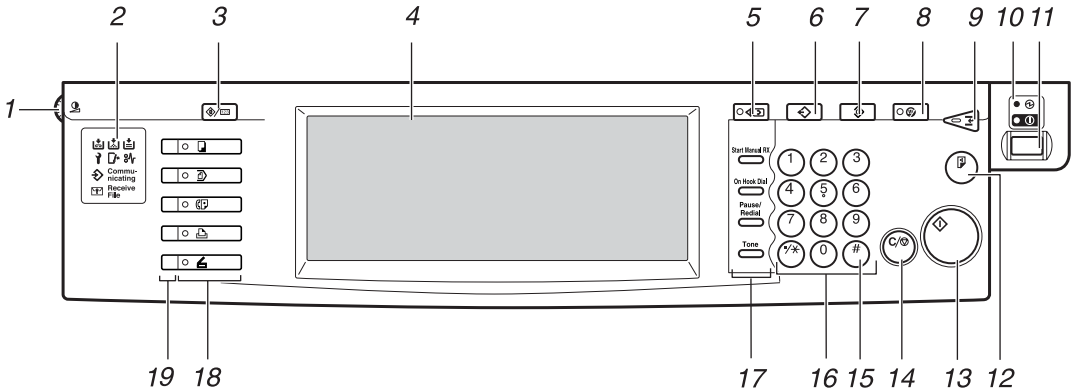

1. Screen contrast knob

Adjusts display panel brightness.

2. Indicators

Show errors and machine status.

- : Add Staple indicator. See p.129 “Adding Staples”.
- : Add Toner indicator. See p.113 “Adding Toner”.
- : Load Paper indicator. See p.110 “Loading Paper”.
- : Service Call indicator
- : Open Cover indicator
- : Misfeed indicator. See p.116 “Clearing Misfeeds”.
- : Data In indicator. See “Control Panel”, *Printer Reference 1*.
- Communicating: Communicating indicator. See “Control Panel”, *Facsimile Reference <Basic Features>*.
- : Confidential File indicator. See “Control Panel”, *Facsimile Reference <Basic Features>*.
- Receiving File: Receiving File indicator. See “Control Panel”, *Facsimile Reference <Basic Features>*.

3. [User Tools/Counter] key

- User Tools
Press to change the default and conditions to meet your requirements. See p.50 “Accessing User Tools (System Settings)”.
- Counter
Press to check or print the counter value. See p.146 “Counter”.

4. Display panel

Displays operation status, error messages, and function menus.

5. [Check Modes] key

Press to check settings.

6. [Program] key (copier/facsimile/scanner mode)

Press to register frequently used settings, or to recall registered settings.

7. [Clear Modes] key

Press to clear previously entered copy job settings.

8. [Energy Saver] key

Press to switch to and from Energy Saver mode. See p.25 “Energy Saver Mode”.

9. [Interrupt] key (copier/scanner mode)

Press to make interrupt copies during copying or scanning. See “Interrupt Copy”, *Copy Reference*.

10. Main power indicator and On indicator

The main power indicator goes on when you turn on the main power switch.

The On indicator lights when the power is on.

Important

Do not turn off the main power switch while the power indicator is lit or blinking. Doing so may damage the hard disk.

11. Operation switch

Press to turn the power on (the **On** indicator goes on). To turn the power off, press again (the **On** indicator goes off).

12. [Sample Copy] key

Press to make a single set of copies or prints to check print quality before making multiple sets.

13. [Start] key

Press to start copying. Start scanning or printing documents stored using the Document Server function.

14. [Clear/Stop] key

- Clear
Press to delete a number entered.
- Stop
Press to stop a job in progress, such as scanning, faxing, or printing.

15. [#] key

Press to enter a value.

16. Number keys





Use to enter the numbers for copies, fax numbers and data for the selected function.

17. [Start Manual RX] key, [On Hook Dial] key, [Pause/Redial] key, and [Tone] key**Reference**

Facsimile Reference <Basic Features> and *Facsimile Reference* <Advanced Features>

18. Function keys

Press to select one of the following functions:

- Copy: 
- Document Server: 
- Facsimile: 
- Printer: 
- Scanner: 

19. Function status indicators

These show the status of the above functions:

- Green: active.
- Red: interrupted.

Display Panel

The display panel shows machine status, error messages, and function menus.

1

Important

r A force or impact of more than 30 N (about 3 kgf) will damage the display panel.



Note

r The following display is of a machine with the optional 2 Tray finisher and LCT installed.

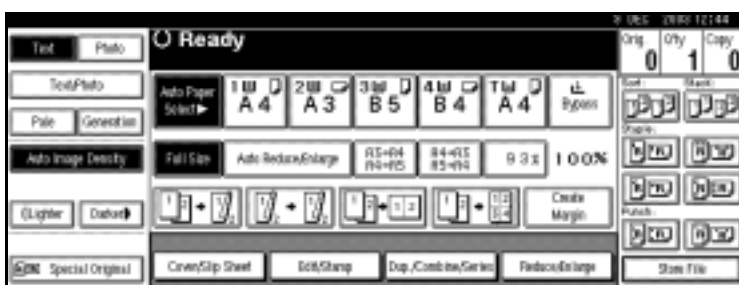
The copying screen is displayed as default after power on.



The function items displayed serve as selector keys. You can select or specify an item by lightly pressing them.

When you select or specify an item on the display panel, it is highlighted like . Keys appearing as  cannot be used.

Common key operations

The following keys are common to all screens:

v Key list

[OK]	Acknowledges a selected function or entered values, and then returns to the previous display.
[Cancel]	Deletes a selected function or entered values, and then returns to the previous display.
[▲Prev.] [▼Next]	Moves to the previous or next display when all items cannot be shown on the same display.
[OK] [Yes]	Closes displayed messages.
[Clear]	Cancels entered values but does not change the settings.
[Exit]	Returns to the previous display.

Turning On the Power

This machine has two power switches.

- v **Operation switch** (right side of the control panel)

Press to activate the machine. When the machine has finished warming up, you can make copies.

- v **Main power switch** (left side of the machine)

Turning off this switch makes the main power indicator on the right side of the control panel go off. When this is done, machine power is completely off.

When the fax unit (optional) is installed, fax files in memory may be lost if you turn this switch off. Use this switch only when necessary.

Note

- r This machine automatically enters Energy Saver mode or turns itself off if you do not use it for a while. See p.58 “Auto Off Timer” and p.58 “Panel Off Timer”.

Turning On the Main Power

- 1** Make sure the power cord is firmly plugged into the wall outlet.

- 2** Open the switch cover and turn on the main power switch.

The main power indicator goes on.

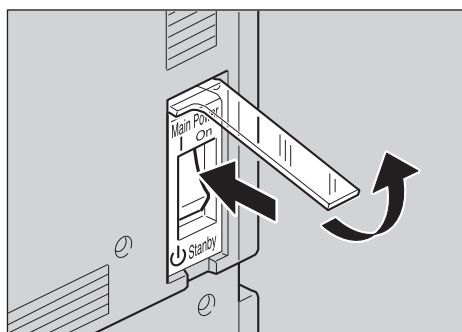

Important

- r Do not turn off the main power switch immediately after turning it on. Doing so may result in damage to the hard disk or memory, leading to malfunctions.

1

Turning On the Power

1 Press the operation switch.

The On indicator goes on.

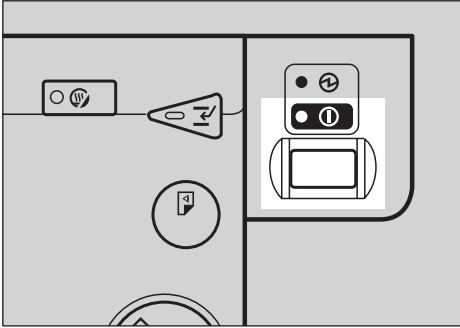

Note

- r If the power does not come on when the operation switch is pressed, check the main power switch is on. If it is off, turn it on.

Turning Off the Power

1 Make sure the exposure glass cover or the ADF is in the right position.

2 Press the operation switch.

The On indicator goes off.

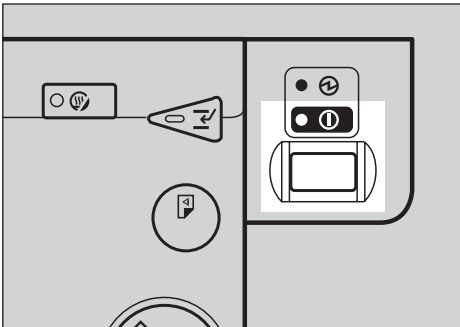

Note

- r Even if you press the operation switch, the indicator does not go out, but blinks in the following cases:
 - When the exposure glass cover or ADF is open.
 - During communication with external equipment.
 - When the hard disk is active.

Turning Off the Main Power

Important

- r Do not turn off the main power switch when the On indicator is lit or blinking. Doing so may result in damage to the hard disk or memory.
- r Make sure to turn off the main power switch before pulling out the power plug. Not doing this may result in damage to the hard disk or memory.

1 Make sure the On indicator is not lit.

2 Open the switch cover, and then turn off the main power switch.

The main power indicator goes out.

When the fax unit (optional) is installed

When the main power switch is turned off while using the fax function, waiting fax and print jobs may be canceled, and incoming fax documents not received. If you have to turn off this switch for some reason, keep the following points in mind:

Important

- r Make sure 100% is shown as available memory on the display before turning off the main power switch or unplugging the power cord. Fax files in memory are deleted an hour after you turn off the main power switch or unplug the power cord. See "Power Failure Report", *Facsimile Reference <Advanced Features>*.
- r The **On** indicator does not go out, but blinks in dial-in mode even if you press the operation switch. When this happens, check the explanations below, and turn off the main power switch.
 - the computer is not controlling the machine.
 - the machine is not receiving a fax.

Saving Energy

Energy Saver Mode

If you do not use the machine for a certain period after an operation, or when you press the **[Energy Saver]** key, the display disappears and the machine goes into Energy Saver mode. When you press the **[Energy Saver]** key again, the machine returns to the ready condition. The machine uses less electricity in Energy Saver mode.

Note

- r You can change the amount of time the machine waits before switching to Energy Saver mode after copying has finished or the last operation is performed. See p.58 "Panel Off Timer".

Auto Off

The machine automatically turns itself off when the job is finished, after a certain period of time has elapsed. This function is called "Auto Off".

Note

- r You can change the Auto Off time. See p.58 "Auto Off Timer".
- r The Auto Off Timer function will not operate in the following cases:
 - When a warning message appears
 - When the service call message appears
 - When paper is jammed
 - When the cover is open

1

- When the "Add Toner" message appears
- When toner is being replenished
- When the User Tools/Counter/Inquiry screen is displayed
- When fixed warm-up is in progress
- When the facsimile, printer, or other functions are active
- When operations were suspended during printing
- When the On-hook dialing function is in use
- When a recipient is being registered in the address list or group dial list
- When the Data In indicator is on or blinking
- When the sample print or locked print screen is displayed



2. Combined Function Operations

Changing Modes

 **Note**

r You cannot switch modes in any of the following situations:

- When scanning in a fax message for transmission
- During immediate transmission
- When accessing User Tools
- During interrupt copying
- During On hook dialing for fax transmission
- While scanning an original

r The copying screen is displayed as default after power on. You can change this default setting. See p.51 “Function Priority”.

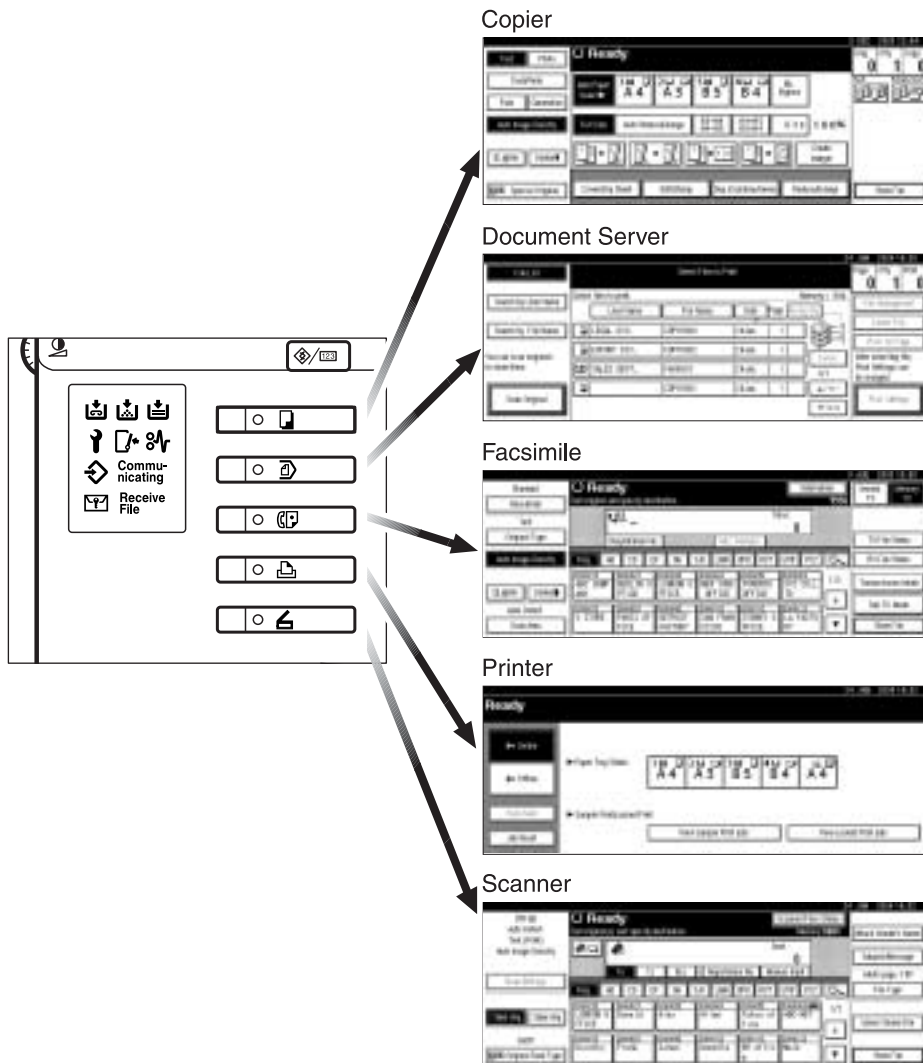



 **System Reset**

The machine returns automatically to its initial condition when the job is finished, after a certain period of time has elapsed. This function is called "System Reset".

 **Note**

r You can change the System Reset time. See p.58 "System Auto Reset Timer".



Multi-Access

You can carry out another job using a different function while the current job is being performed. Performing multiple functions simultaneously like this is called "Multi-accessing".

This allows you to handle jobs efficiently, regardless of how the machine is being used. For example:

- While making copies, you can scan documents to store in the Document Server.
- While printing documents stored in the Document Server, the machine can receive print data.
- You can make copies while receiving fax data.
- While printing print data, you can make operations for copying.

Note

- r See p.51 "Print Priority" for setting function priority. As default, [Display Mode] is set to first priority.
- r When the optional 1000-sheet finisher, 2 Tray finisher or booklet finisher is installed on the machine, you can specify the output tray where documents are delivered. For details about how to specify the output tray for each function, see the following descriptions:
 - p.53 "Output: Copier (copier)"
 - p.53 "Output: Document Server (Document Server)"
 - p.53 "Output: Facsimile (facsimile)"
 - p.54 "Output: Printer (printer)"

 **Function compatibility**

The chart shows function compatibility when print priority is set to "Interleave". See p.51 "Print Priority".

△: Simultaneous operations are possible.

●: Operation is enabled when the relevant function key is pressed and remote switching (of the scanner) is done.

m: Operation is enabled when the **[Interrupt]** key is pressed to interrupt the preceding operation.

→: Operation is performed automatically once the preceding operation ends.

×: The operation must be started once the preceding operation ends. (Simultaneous operations are not possible.)

Function you want to select		Copier			Facsimile				Printer			Scanner		Document Server											
		Using the control panel		Interrupt Copying	Transmission		Reception		Print			Document Server		DeskTopBinder V2 Professional/Lite	Web Document Server										
Function in progress		Using the control panel	Stapling	Sort	Using the control panel	Copying	Using the control panel	Scanning an Original for Memory Transmission	Memory Transmission	Immediate Transmission	Memory Reception	Printing Received Data	Data Reception	Printing	Stapling	Using the control panel	Scanning using the Network TWAIN Scanner	Scanning	Using the control panel	Scanning a Document to Store in Document Server	Printing from Document Server	Printing from Document Server	Sending a Fax from Document Server	Printing	
Copier	Using the control panel	×	×	×	m	m	●	●	△	●	△	△	△	△	△	●	●	●	●	●	△	△	△	m	
	Stapling	△ ^{*1}	→ ^{*1}	→ ^{*1}	m	m ^{*5}	●	● ^{*2}	△	● ^{*2}	△	△	△	△	→	●	● ^{*2}	● ^{*2}	●	● ^{*2}	△ ^{*4}	△ ^{*4}	△	△	m ^{*4}
	Sort	△ ^{*1}	→ ^{*1}	→ ^{*1}	m	m	●	● ^{*2}	△	● ^{*2}	△	△	△	△	△	●	● ^{*2}	● ^{*2}	●	● ^{*2}	△	△	△	△	m
Interrupt Copying	Using the control panel	m	m	m	×	×	×	×	△	×	△	△	△	△	△	×	×	×	×	×	×	△	△	△	m
	Copying	m	m	m	×	×	×	×	△	×	△	→	△	→	→	×	×	×	×	×	×	→	△	△	→

Function in progress	Function you want to select			Copier			Facsimile			Printer			Scanner			Document Server			DeskTopBinder V2 Professional/Lite			Web Document Server				
	Using the control panel	Stapling	Sort	Using the control panel	Interrupt Copying	Copying	Using the control panel	Scanning an Original for Memory Transmission	Memory Transmission	Immediate Transmission	Memory Reception	Printing Received Data	Data Reception	Printing	Stapling	Using the control panel	Scanning using the Network TWAIN Scanner	Scanning	Using the control panel	Scanning a Document to Store in Document Server	Printing from Document Server	Printing from Document Server	Sending a Fax from Document Server	Printing		
Facsimile	Using the control panel	●	●	●	m	m	×	×	△	×	△	△	△	△	△	△	△	△	△	△	△	△	△	△	m	
	Scanning an Original for Memory Transmission	×	×	×	×	×	×	×	△	×	△	△	△	△	△	×	×	×	×	×	×	△	△	△	m	
	Memory Transmission	△	△	△	△	△	△	△	△	△	△	△	△	△	△	△	△	△	△	△	△	△	△	△	△	m
	Immediate Transmission	×	×	×	×	×	×	×	△	×	△	△	△	△	△	×	×	×	×	×	×	△	→	△	m	
	Memory Reception	△	△	△	△	△	△	△	△	△	△	△	△	△	△	△	△	△	△	△	△	△	△	△	△	m
Printer	Printing Received Data	△	△	△	△	△	△	△	△	△	△	×	△	△	△	△	△	△	△	△	△	△	△	△	△	m
	Data Reception	△	△	△	△	△	△	△	△	△	△	△	→	→	→	△	△	△	△	△	△	△	△	△	△	m
Scanner	Sort Print	△	△	△	m	m	△	△	△	△	△	△	△	→	→	△	△	△	△	△	△	△	△	△	△	m
	Stapling	△	→	△	m	m ^{*5}	△	△	△	△	△	△	△	→	→	△	△	△	△	△	△	△	△	△	m ^{*4}	
	Using the control panel	●	●	●	m	m	●	●	m	●	△	△	△	△	△	△	△	△	△	△	△	△	△	△	△	m
Document Server	Scanning using the Network TWAIN Scanner	×	×	×	×	×	×	×	△	×	△	△	△	△	△	×	×	×	×	×	×	△	△	△	△	m
	Scanning	●	×	×	m	m	●	×	△	×	△	△	△	△	△	×	×	×	●	×	×	×	△	△	m	
	Using the control panel	●	●	●	m	m	●	●	△	●	△	△	△	△	△	●	●	●	×	×	×	×	△	△	△	m
DeskTopBinder V2 Professional/Lite	Scanning a Document to Store in Document Server	●	×	×	m	m	●	×	△	×	△	△	△	△	△	×	×	×	×	×	×	△	△	△	m	
	Printing from Document Server	●	△ ^{*4}	△	m	m	△	△	△	△	△	△	△	△	△	△	△	△	△	△	△	△	△	△	△	m
Web Document Server	Printing from Document Server	△	△ ^{*4}	△	△	△	△	△	△	△	△	△	△	△	△	△	△	△	△	△	△	△	△	△	△	m
	Sending a Fax from Document Server	△	△	△	△	△	△	△	△	△	△	△	△	△	△	△	△	△	△	△	△	△	△	×	△	m

Function you want to select		Copier			Facsimile				Printer		Scanner		Document Server	DeskTopBinder V2 Professional/Lite	Web Document Server
Function in progress		Using the control panel	Interrupt Copying	Transmission	Reception	Print	Document Server	DeskTopBinder V2 Professional/Lite	Web Document Server						
Web Document Server	Printing	△	△	△	△	△	△	△	△	△	△	△	△	△	△
		△ ⁴	△	△	△	△	△	△	△	△	△	△	△	△	△
		△	△	△	△	△	△	△	△	△	△	△	△	△	△
		△	△	△	△	△	△	△	△	△	△	△	△	△	△
		△	△	△	△	△	△	△	△	△	△	△	△	△	△
		△	△	△	△	△	△	△	△	△	△	△	△	△	△
		△	△	△	△	△	△	△	△	△	△	△	△	△	△
		△	△	△	△	△	△	△	△	△	△	△	△	△	△
		△	△	△	△	△	△	△	△	△	△	△	△	△	△
		△	△	△	△	△	△	△	△	△	△	△	△	△	△
		△	△	△	△	△	△	△	△	△	△	△	△	△	△
		△	△	△	△	△	△	△	△	△	△	△	△	△	△
		△	△	△	△	△	△	△	△	△	△	△	△	△	△
		△	△	△	△	△	△	△	△	△	△	△	△	△	△
		△	△	△	△	△	△	△	△	△	△	△	△	△	△

*1 Simultaneous operations are only possible once the preceding job documents are all scanned and [Next Job] appears.
 *2 You can scan a document once the preceding job documents are all scanned.
 *3 Simultaneous operations are only possible with an additional line installed and when the fax function is not using the line given priority in the facsimile settings.
 *4 During stapling, printing automatically starts after the current job.
 *5 Stapling is not available.
 *6 Simultaneous operations become possible after you press [Next Job].
 *7 During parallel reception, any subsequent job is suspended until reception is completed.

Limitation

r Stapling cannot be used at the same time for multiple functions.

Note

- r A machine with the 1000-sheet finisher installed, that is printing with the stapling operation on paper larger than A4 size, starts the subsequent job (for which the finisher shift tray is specified as the output tray) only after the current print job finishes.
- r While printing is in progress, scanning using another function may take more time.



3. Document Server

Relationship between the Document Server and Other Functions

The following table describes the relationship between the Document Server and other functions.

Function	Where to store documents	Displaying a list	Printing stored documents	Sending documents
Copier	Copier/Document Server	available	available	not available
Printer	Document Server	available	available	not available
Facsimile	Facsimile	available	available	available ^{*1}
Scanner	Scanner	not available ^{*2}	not available	available ^{*3}

^{*1} You can send stored documents using the fax function. See “Sending a Stored File”, *Facsimile Reference* <Advanced Features>.

^{*2} You can display stored documents using scanner function. See “Viewing a List of Stored Files”, *Scanner Reference*.

^{*3} You can send stored documents from scanner mode. See “Sending Stored Files by E-mail or Scan to Folder, or Delivering”, *Scanner Reference*.

Note

r The following table shows the capacity of the Document Server.

	Number of pages for each file	Number of files	Number of pages in total
Copier	1,000 pages	3,000 files	9,000 pages
Printer			
Scanner			
Facsimile			

Document Server Display

v Document Server Main Display

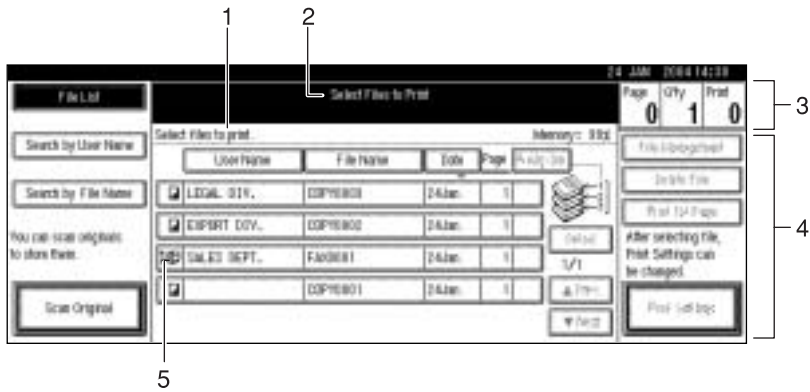

1. Operating status and messages.

2. The title of the currently selected screen.

3. The numbers of originals, copies, and printed pages.

4. The operation keys.

5. The functions under which the documents were stored.

The icons below show the functions active when the documents were stored in the Document Server.

Mode	Copier	Facsimile	Printer	Scanner
Icon				--

Using the Document Server

Storing Data

✓ File name

Stored documents are automatically named "COPY0001", "COPY0002". You can change assigned file names.

✓ User name

You can register a user name to identify the user or user group that stored the documents. To assign it, you can register the user name using the name assigned to the user code, or by entering the name directly.

Reference

For details about user codes, see p.70 "User Code".

✓ Password

You can set a password for stored documents, and use it to prevent others printing them. When a password is set for the documents,  appears next to the documents.

Reference

To store documents without using Document Server functions, see the manuals for those modes.

Important

- r Data stored in the machine might be lost if some kind of failure occurs. The manufacturer shall not be responsible for any damage resulting from loss of data.

Note

- r Data stored in the Document Server is set to be deleted after three days (72 hours) by default. You can specify the period after which stored data is automatically deleted. See p.65 "Auto Delete File".

- r If you do not want stored data to be automatically deleted, select [No] in Auto Delete File before storing a document. If you select [Yes] later, data stored after will be automatically deleted.

1 Press the [Document Server] key.

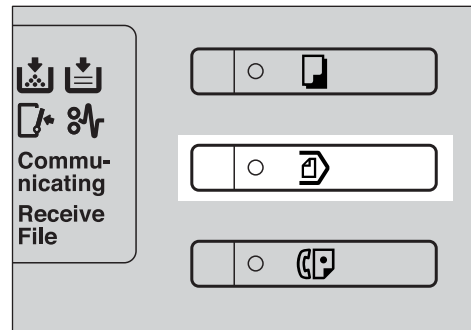

2 Press [Scan Original].

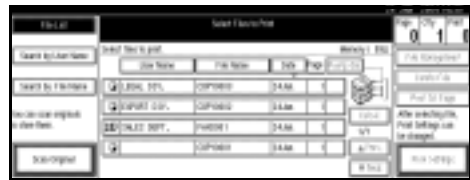

3 Enter a file name, user name, or password if necessary.

Note

- r If you do not enter a file name, one is automatically assigned.

Reference

- p.36 "To register or change the user name"
- p.37 "To change the file name"
- p.37 "To set or change the password"

4 Place originals either on the exposure glass or in the ADF.

Reference

For information about types of originals and how to place them, see *Copy Reference*.

5 Make any required settings.



Reference

For details, see *Copy Reference*.

6 Press the [Start] key.

The document is stored in the Document Server.

Note

- r To stop scanning, press the [Clear/Stop] key. To restart a paused scanning job, press [Continue] in the confirmation display. To delete saved images and cancel the job, press [Stop].
- r When a password is set, **1** appears on the left side of the file name.
- r After scanning, stored documents appear on the Select Files to Print display. If this display does not appear, press [Scanning Finished].
- r When placing an original on the exposure glass, press [Scanning Finished] after all the originals have been scanned.

To register or change the user name

1 Press [Scan Original].

The Scan Original display appears.

2 Press [User Name].



If user names are already registered, the Change User Name display appears. To use an unregistered user name, press [Non-programmed Name].

When no user name are registered in the Address Book, the User (Destination) Name entry display appears.

When using a registered user name in the Address Book

A Select a registered user name from the list, and then press [OK].



To change your user name to an unregistered user name, proceed to the next step.

Reference

p.70 "Registering a New User Code"

When using an unregistered user name in the Address Book

- A To enter an unregistered user name, press [Non-programmed Name].**
- B Enter a new user name, and then press [OK].**

 **Reference**
p.147 “Entering Text”

When no user name has been registered in the Address Book

- A Enter a new user name, and then press [OK].**



 **Reference**
p.147 “Entering Text”

To change the file name

- 1 Press [Scan Original].**
The Scan Original display appears.
- 2 Press [File Name].**



The Change File Name display appears.

- 3 Press [Delete All] to delete the old file name.**

-  **Note**
- r You can also use [Backspace] to delete unnecessary characters.

- 4 Enter a new file name, and then press [OK].**

-  **Note**
- r Up to 20 characters can be entered as a file name. Note that only 15 characters of each file name appear in the document list.

 **Reference**
p.147 “Entering Text”

To set or change the password

- 1 Press [Scan Original].**
The Scan Original display appears.
- 2 Press [Password].**



- 3 Enter a password using the number keys (four digits), and then press the [#] key.**
- 4 Reenter the password (four digits) for verification, and then press the [#] key.**
- 5 Press [OK].**

Changing Stored Document's File Name, User Name, or Password

- 1 Press the [Document Server] key.
- 2 Select the document with the user name, file name, or password you want to change.

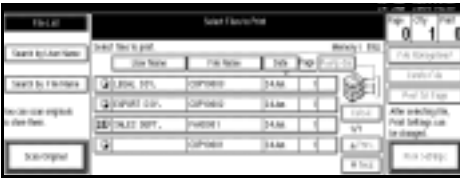

Note

- r If a password is already set for the document, enter that password, and then press [OK].

- 3 Press [File Management].

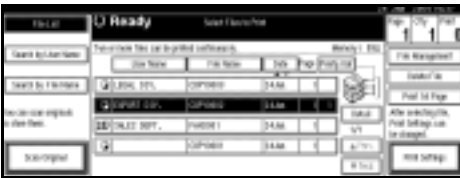

- 4 Press [Change File Name], [Change User Name], or [Change Password].

- 5 Enter the new file name, user name, or password using the letter keys or number keys, and then press [OK].

Reference

- p.36 "To register or change the user name"
- p.37 "To change the file name"
- p.37 "To set or change the password"

- 6 Press [OK].

Selecting a Document

- 1 Press the [Document Server] key.
- 2 Select a document you want to print.



Note

- r If a password is already set for the document, enter that password, and then press [OK].
- r You can search for the document using [Search by User Name] or [Search by File Name] at the left top of the display. See p.39 "Searching for Stored Documents".
- r You can sort document names in the list by user name, file name, or date. To sort documents, press [User Name], [File Name], or [Date].
- r If you cannot determine document content from the file name, you can print just the first page of the document for checking purposes. See p.42 "Printing first page".
- r To cancel a document selection, press it again.

3 To print multiple documents, repeat step **2** in the order you want to print.

Note

- r You can select up to 30 documents.
- r If the sizes or resolution of selected documents are not the same, it may not be possible to print them.
- r If you want to change the printing order, cancel the selection, and select documents again, this time in the order you want.
- r If you press the **[Clear Modes]** key, selection of all documents will be canceled.
- r If you press **[Printg Odr]**, the documents appear in print order.

To check the details of stored documents

1 Select a document to display its detailed information.

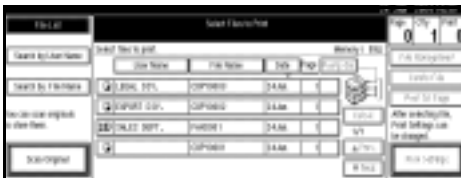

Note

- r If a password is already set for the document, enter that password, and then press **[OK]**.

2 Press **[Detail]**.



Detailed information about the document appears.

Note

- r If you selected several documents, use **[▲]** and **[▼]** to view the details of each.
- r Press **[OK]**. The Select Files to Print display reappears.

Searching for Stored Documents

You can use either **[Search by File Name]** or **[Search by User Name]** to search for documents stored in the Document Server. You can also list stored documents in a preferred order.

Note

- r If you install DeskTopBinder V2 Professional or DeskTopBinder V2 Lite on your computer, you can search for and rearrange documents using your computer.

Reference

Manuals for DeskTopBinder V2 Professional/Lite or Help

To search by file name

1 Press the **[Document Server]** key.

2 Press **[Search by File Name]**.

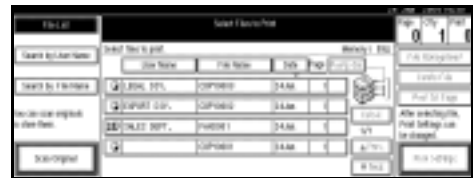

3 Enter the file name using the letter keys, and then press **[OK]**.

Only files beginning with the name entered appear in the Select Files to Print display.

Reference

p.147 “Entering Text”.

Note

- r To display all files stored in the Document Server, press [File List].

Note

- r To display all files stored in the Document Server, press [File List].

To search by user name

3

- 1 Press the [Document Server] key.
- 2 Press [Search by User Name].

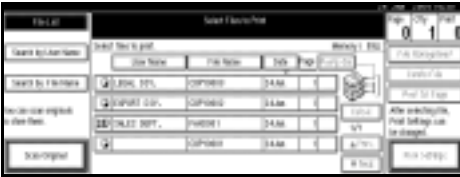

- 3 To specify a registered user name, select the user name from the displayed list, and then press [OK].

Note

- r To specify an unregistered user name, follow the procedure below.

- 4 To specify an unregistered user name, press [Non-programmed Name]. Enter a user name, and then press [OK].



Reference

p.147 “Entering Text”

- 5 Press [OK].

Only files beginning with the name entered appear in the Select Files to Print display.

Printing Stored Documents

Note

- r You can print stored documents from a network computer using a Web browser. For details about how to start the Web browser, see *Network Guide*.

- 1 Select a document.

Note

- r If a password is already set for the document, enter that password, and then press [OK].
- r You can print multiple documents. See p.38 “Selecting a Document”.

- 2 If you need to change print settings, press [Print Settings].

The Print Settings display appears. User names, file names, and print order of documents appear.

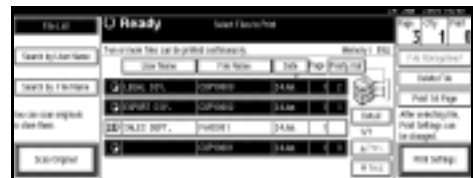

Note

- r Print settings made for printing in copier or printer function remain after printing and applied to the next job. Print settings made in facsimile mode, however, do not remain.
- r If you select multiple documents, print settings remain applied to the first document, but not to other documents.

r Print setting items are listed below. For details about print results of each setting, see *Copy Reference*.

v **Binding format**

- Two-sided Copy Top to Top
- Two-sided Copy Top to Bottom
- Booklet
- Magazine

v **Cover handling**

- Cover/Slip sheet
- Edit/Stamp

v **Finish**

- Sort
- Stack
- Staple
- Punch (optional)

r If you print more than one set using the Sort function, you can check the print result by printing out only the first set. See p.42 “Sample copy”.

r When multiple documents are printed at the same time, you can combine them into a single set by adjusting the print order.

r When multiple documents are printed at the same time, print settings made for the document printed first are applied to all other documents.

r If you select multiple files, you can check file names or print order selected in step 1 by scrolling the list using [▼] and [▲].

r Press [Select File] to return to the Select Files to Print display.

r The Booklet, Magazine, and Stamp functions are not available for documents stored in facsimile mode.

3 Enter the required number of prints using the number keys.



Note

r Up to 999 can be entered.

4 Press the [Start] key.

Printing starts.

To stop printing

1 Press the [Clear/Stop] key.

2 Press [Stop].

Changing the number of copies during printing

Limitation

r The number of copies can only be changed when the Sort function is selected in the print settings.

1 Press the [Clear/Stop] key.

2 Press [Change Quantity].

3 Enter a new number of copies using the number keys.

4 Press the [#] key.

5 Press [Continue].

Printing restarts.

Sample copy

If you print multiple sets using the Sort function, you can check the print order or print settings are correct by printing only the first set using the **[Sample Copy]** key.

Limitation

- r This function can only be used when the Sort function is selected.

1 Select the document.

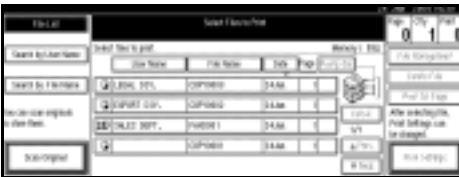

Note

- r If a password is already set for the document, enter that password, and then press **[OK]**.
- r You can search for the document using **[Search by User Name]** or **[Search by File Name]** at the left top of the display. See p.39 “Searching for Stored Documents”.
- r You can sort document names in the list by user name, file name, or date. To sort documents, press **[User Name]**, **[File Name]**, or **[Date]**.
- r To cancel a document selection, press it again.

2 Press the **[Sample Copy]** key.

The first set prints out.

3 Press **[Continue]**.

Printing restarts.

Note

- r Press **[Suspend]** to cancel printing and return to the Print Settings menu to change settings.

Printing first page

You can print the first page of the document selected in the Select Files to Print display to check its content.

If more than one document is selected, the first page of each is printed.

1 Select the document.

Note

- r If a password is already set for the document, enter that password, and then press **[OK]**.
- r You can search for the document using **[Search by User Name]** or **[Search by File Name]** at the left top of the display. See p.39 “Searching for Stored Documents”.
- r You can sort document names in the list by user name, file name, or date. To sort documents, press **[User Name]**, **[File Name]**, or **[Date]**.
- r To cancel a document selection, press it again.

2 Press **[Print 1st Page]**.

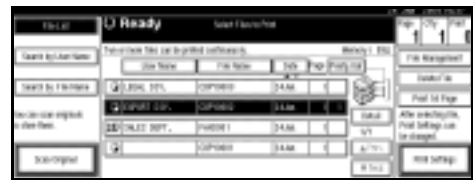

3 Press the **[Start]** key.

Deleting Stored Documents

Important

- r You can store up to 3,000 documents in the Document Server. No more documents can be stored when the total is 3,000. You should delete unnecessary documents to increase available memory.

Note

- r You can delete all the stored documents at once with User Tools. See p.65 “Delete All Files”.
- r You can delete stored documents from a network computer using the Web browser. For details about how to start the Web browser, see *Network Guide*.

1 Press the [Document Server] key.

2 Select the document to delete.

Note

- r If a password is already set for the document, enter that password, and then press [OK].
- r You can delete multiple documents at once. See p.38 “Selecting a Document”.
- r You can search for a document by user or file name, using [Search by User Name] or [Search by File Name] respectively. See p.39 “Searching for Stored Documents”.
- r You can sort document names in the list by the user name, file name, or date. To sort documents, press [User Name], [File Name], or [Date].
- r If you cannot find the document by name, you can print the first page of a document to check its contents. See p.42 “Printing first page”.

- r Press the selected line again to cancel the print job.

3 Press [Delete File].

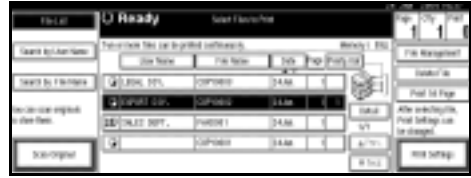

4 Press [Delete] to delete the document.

Viewing Stored Documents Using a Web Browser

Reference

The Web browser's Help.

1 Start a Web browser.

2 Enter “http:// (IP address of this machine) /” in the [Address] box.

The top page appears on the Web browser.

3 Click [Document Server].

The [Document Server File List] appears.

Note

- r To switch the display format, click [Details], [Thumbnails] or [Icons] from the [Display method] list.

4 Click the properties button of the document you want to check.

Information about that document appears.

5 Confirm the document's content.

Note

- r To enlarge the document preview, click [Enlarge Image].

Downloading Stored Documents

Note

- r File format converter is required when downloading documents stored in copier or printer mode.

1 Start a Web browser.

2 Enter “http:// (IP address of this machine) /” in the [Address] box.

The top page appears on the Web browser.

3 Click [Document Server].

The [Document Server File List] appears.

Note

- r To switch the display format, click [Details], [Thumbnails] or [Icons] from the [Display method] list.

4 Click the properties button of the document you want to download.

5 Select [PDF], [JPEG], or [Multi-page TIFF] in the [File format] list.

Note

- r [Multi-page TIFF] is available when file format converter is installed.
- r [JPEG] can only be selected for documents stored in scanner mode.

6 Click [Download].

7 Click [OK].

Settings for the Document Server

- v Copier/Document Server Features (See "General Features 4/4", *Copy Reference*.)

Items	Default	
General Features	Document Server Storage Key: F1	<i>2 Sided Original Top to top</i>
	Document Server Storage Key: F2	<i>1 Sided→1 Sided Combine</i>
	Document Server Storage Key: F3	<i>1 Sided→1 Sided Combine: 4 originals</i>
	Document Server Storage Key: F4	<i>1 Sided→1 Sided Combine: 8 originals</i>
	Document Server Storage Key: F5	<i>Create Margin</i>

- v System Settings (See p.51 "General Features", p.55 "Tray Paper Settings", p.58 "Timer Settings", and p.59 "Key Operator Tools".)

Items	Default	
General Features	Warm Up Notice	<i>ON</i>
	Copy Count Display	<i>Up</i>
	Output: Document Server	<i>Internal Tray 1</i>
Tray Paper Settings	Paper Tray Priority: Copier	<i>Tray 1</i>
	Cover Sheet Tray	<i>Off</i>
	Slip Sheet Tray	<i>Off</i>
Timer Settings	Copier/Document Server Auto Reset Timer	<i>60 seconds</i>
Key Operator Tools	Auto Delete File	<i>Yes After 3 day(s)</i>
	Delete All Files	<i>--</i>
	Password Management for Stored Files	<i>Do not Unlock</i>

4. User Tools (System Settings)

User Tools Menu (System Settings)

Reference

For details about Interface Settings and File Transfer, see “User Tools Menu (System Settings)”, *Network Guide*.

For details about parallel interface, see “System Settings (Parallel Connection)”, *Printer Reference 2*.

v General Features (See p.51 “General Features”.)

	Default
Panel Tone	<i>ON</i>
Warm Up Notice	<i>ON</i>
Copy Count Display	<i>Up</i>
Function Priority	<i>Copier</i>
Print Priority	<i>Display mode</i>
Function Reset Timer	<i>3 Seconds</i>
Output: Copier	<i>Internal Tray 1</i>
Output: Document Server	<i>Internal Tray 1</i>
Output: Facsimile	<i>Internal Tray 2</i>
Output: Printer	<i>Internal Tray 1</i>
Prepare Stapling	--
<F/F4>Size Setting	<i>8¹/₂" × 13" </i>

v Tray Paper Settings (See p.55 “Tray Paper Settings”.)

	Default
Paper Tray Priority: Copier	Tray 1
Paper Tray Priority: Facsimile	Tray 1
Paper Tray Priority: Printer	Tray 1
Tray Paper Size: Tray 1	A4 <input type="checkbox"/> , 8 ¹ / ₂ " × 11" <input type="checkbox"/>
Tray Paper Size: Tray 2	A3 <input type="checkbox"/> , 11" × 17" <input type="checkbox"/>
Tray Paper Size: Tray 3	A4 <input type="checkbox"/> , 8 ¹ / ₂ " × 11" <input type="checkbox"/>
Tray Paper Size: Tray 4	A4 <input type="checkbox"/> , 8 ¹ / ₂ " × 14" <input type="checkbox"/>
Paper Type: Bypass tray	No display
Paper Type: Tray 1	No display/2 Sided Copy/Auto Paper Select on
Paper Type: Tray 2	No display/2 Sided Copy/Auto Paper Select on
Paper Type: Tray 3	No display/2 Sided Copy/Auto Paper Select on
Paper Type: Tray 4	No display/2 Sided Copy/Auto Paper Select on
Paper Type: LCT	No display/2 Sided Copy/Auto Paper Select on
Cover Sheet Tray	Off
Slip Sheet Tray	Off

v Timer Settings (See p.58 “Timer Settings”.)

	Default
Auto Off Timer	1 minute(s)
Panel Off Timer	1 minute(s)
System Auto Reset Timer	60 seconds
Copier/Document Server Auto Reset Timer	60 seconds
Facsimile Auto Reset Timer	30 seconds
Scanner Auto Reset Timer	60 seconds
Set Date	--
Set Time	--

v Interface Settings

- For details about network settings, see “User Tools Menu (System Settings)”, *Network Guide*.
- For details about parallel interface, see “System Settings (Parallel Connection)”, *Printer Reference 2*.

v File Transfer

See “User Tools Menu (System Settings)”, *Network Guide*.

v Key Operator Tools (See p.59 "Key Operator Tools".)

		Default
User Code Management	Copier	<i>OFF</i>
	Document Server	<i>OFF</i>
	Facsimile	<i>OFF</i>
	Scanner	<i>OFF</i>
	Printer	<i>Auto Program</i>
Key Counter Management		<i>All OFF</i>
External Charge Unit Management		--
Key Operator Code		<i>OFF</i>
Extended Security		<i>Off</i>
Display/Print Counter		--
Display/Clear/Print Counter per User Code		--
Print Address Book: Destination List		--
Address Book Management		--
Address Book: Program/Change/Delete Group		--
Address Book: Program/Change/Delete Transfer Request		--
Address Book: Change Order		--
Address Book: Edit Title		--
Address Book: Select Title		<i>Title 1</i>
Auto Delete File		<i>After 3 day(s)</i>
Delete All Files		--
Password Management for Stored Files		<i>Do not Unlock</i>
AOF (Always ON)		<i>ON</i>
Program/Change LDAP Server		--
Use LDAP Server		<i>Off</i>

Accessing User Tools (System Settings)

This section is for key operators in charge of this machine.

User Tools allow you to change or set defaults.

Note

Operations for system settings differ from normal operations. Always quit User Tools when you have finished. See p.50 “Quitting User Tools”.

Any changes you make with User Tools remain in effect even if the main power switch or operation switch is turned off, or the [Energy Saver] or [Clear Modes] key is pressed.

4 Change settings by following instructions on the display panel, and then press [OK].

Note

To cancel changes made to settings and return to the initial display, press the [User Tools/Counter] key.

4

Quitting User Tools

1 Press the [User Tools/Counter] key.



Note

You can also quit User Tools by pressing [Exit].

Changing Default Settings

Note

If a key operator code is already set, the key operator code entry display appears. Enter the key operator code, and then press [OK]. See p.60 “Key Operator Code”.

1 Press the [User Tools/Counter] key.



2 Press [System Settings].

3 Select the menu, and then press the appropriate key.

Reference

p.47 “User Tools Menu (System Settings)”



Settings You Can Change with User Tools

Reference

To access User Tools, see p.50 “Accessing User Tools (System Settings)”.

General Features

v Panel Tone

The beeper (key tone) sounds when a key is pressed.

Note

r Default: *ON*

v Warm Up Notice (copier/Document Server)

You can have the beeper sound when the machine becomes ready to copy after leaving Energy Saver mode, or when the power is turned on.

Note

r If the Panel Tone setting is “OFF”, the beeper does not sound, whatever the Warm Up Notice setting.

r Default: *ON*

v Copy Count Display (copier/Document Server)

The copy counter can be set to show the number of copies made (count up) or the number of copies yet to be made (count down).

Note

r Default: *Up (count up)*

v Function Priority

You can specify the mode to be displayed immediately after the operation switch is turned on, or when System Reset mode is turned on.

Note

r Default: *Copier*

v Print Priority

Gives print priority to the mode displayed.

Reference

p.29 “Multi-Access”

Note

r Default: *Display mode*

r When [Interleave] is selected, the current print job will be interrupted after a maximum of five sheets.

r When the optional internal tray 2, 1000-sheet finisher, 2 Tray finisher or booklet finisher is installed on the machine, you can specify an output tray for documents delivery. For details about how to specify an output tray for each function, see the following sections:

- p.53 “Output: Copier (copier)”
- p.53 “Output: Document Server (Document Server)”
- p.53 “Output: Facsimile (facsimile)”
- p.54 “Output: Printer (printer)”

v **Function Reset Timer**

You can set the length of time the machine waits before changing modes when using the multi-access function (see p.29 “Multi-Access”). This is useful if you are making many copies and have to change settings for each copy. If you set a longer reset period, you can prevent interruption from other functions.

Note

r Default: *Set Time*

r The Function Reset Timer setting is ignored if Interleave is set for Print Priority (see p.51 “Print Priority”).

r When you select [**Set Time**], enter the time (3–30 seconds, in 1 second increments) using the number keys.

r The default time is three seconds.

v Output: Copier (copier)

You can specify a tray to which documents are delivered.

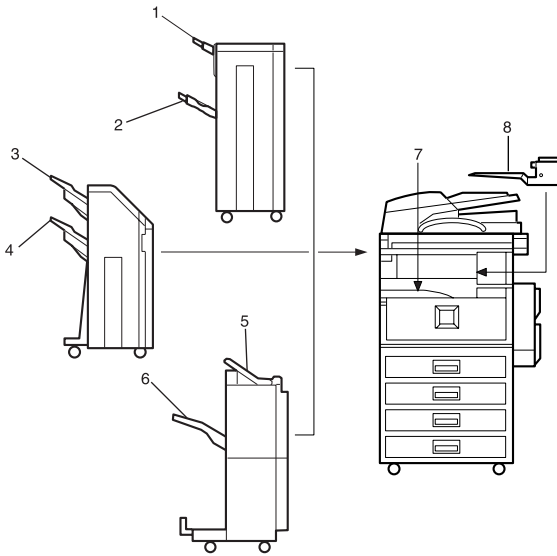

1. Finisher Upper Tray

2. Finisher Shift Tray

3. Finisher Shift Tray 1

4. Finisher Shift Tray 2

5. Finisher Upper Tray

6. Finisher Shift Tray

7. Internal Tray 1

8. Internal Tray 2

Note

r Default: *Internal Tray 1*

v Output: Document Server (Document Server)

You can specify a tray to which documents are delivered.

Note

r Default: *Internal Tray 1*

r For details about output trays, see p.53 “Output: Copier (copier)”.

v Output: Facsimile (facsimile)

You can specify a tray to which documents are delivered.

Note

r Default: *Internal Tray 2*

r For details about output trays, see p.53 “Output: Copier (copier)”.

v Output: Printer (printer)

You can specify a tray to which documents are delivered.

 **Note**

r Default: *Internal Tray 1*

r The output trays set on the printer driver have priority over the output tray specified above.

r For details about output trays, see p.53 “Output: Copier (copier)”.

v Prepare Stapling

When the booklet finisher is installed, perform a stapling test (five to seven times) after replacing staples for saddle stitching, or removing jammed staples.

 **Note**

r The display for this setting appears only when the booklet finisher is installed. See p.133 “Using “Prepare Stapling ”in User Tools to initialize the staple unit”.

v <F/F4>Size Setting

Currently three types of F size are available; 8¹/₂"×13"☐, 8¹/₄"×13"☐ and 8"×13"☐. The ADF or exposure glass cover sensor cannot distinguish these three types of originals. This function sets the F size from the ADF or exposure glass cover sensor. Auto Paper Select or Auto Reduce/Enlarge can be used for F size originals based on this setting.

 **Note**

r Default: 8¹/₂"×13"☐

Output tray settings

 **Limitation**

r You cannot interrupt the current stapling job even if a stapling job is specified by a different function.

r When the 1000-sheet finisher, 2 Tray finisher or booklet finisher is installed and stapling or shift-sorting is specified for a job, the job will be delivered to the finisher shift tray, finisher shift tray 1 or finisher shift tray 2 regardless of the output tray specified.

Tray Paper Settings

✓ Paper Tray Priority: Copier (copier/Document Server)

You can specify the tray to supply paper for output.

Note

r Default: *Tray 1*

✓ Paper Tray Priority: Facsimile (facsimile)

You can specify the tray to supply paper for output.

Note

r Default: *Tray 1*

✓ Paper Tray Priority: Printer (printer)

You can specify the tray to supply paper for output.





















Note

r Default: *Tray 1*

✓ Tray Paper Size: Tray 1–4

Select the size of the paper loaded in the paper tray.

- The paper sizes you can set for Tray 1 to Tray 4 are as follows:









- A3 , B4 JIS (Japanese Industrial Standard) , A4 , A4 , B5 JIS , B5 JIS , A5 
- 11"×17" , 8¹/₂"×14" , 8¹/₂"×13" , 8¹/₂"×11" , 8¹/₂"×11" , 8¹/₄"×13" , 8¹/₄"×14" , 11"×14" , 8"×13" , 7¹/₄"×10¹/₂" , 8"×10¹/₂" , 8"×10¹/₂" , 5¹/₂"×8¹/₂" 

Important

- r If the specified paper size differs from the actual size of the paper loaded in the paper tray, a misfeed might occur because the correct paper size was not detected.

Note

r Default:

- Tray 1: A4 , 8¹/₂" × 11" 
- Tray 2: A3 , 11" × 17" 
- Tray 3: A4 , 8¹/₂" × 11" 
- Tray 4: A4 , 8¹/₂" × 14" 

- r The paper guide for the optional LCT is fixed for A4 , 8¹/₂" × 11"  size paper. Contact your service representative if you need to change the paper size.

- r If the paper size set for the selector in the paper tray is different to the paper size for this setting, the paper size of the selector has priority.

- r If you load paper of a size not indicated on the paper size selector in the paper tray, set the selector to "✱".

 **Reference**

p.126 “Changing the Paper Size”

v Paper Type: Bypass tray

Sets the display so you can see what type of paper is loaded in the bypass tray.

- The paper types you can set for the bypass tray are as follows:
 - recycled paper, special paper, colour paper, letterhead, label paper, pre-punched paper, bond paper, cardstock, thick paper, OHP

 **Note**

r Default: *No display*

v Paper Type: Tray 1–4

Sets the display so you can see what type of paper is loaded in each paper tray. The print function use this information to automatically select the paper tray.

- The paper types you can set are as follows:
 - recycled paper, special paper, colour paper, letterhead, preprinted paper, prepunched paper, bond paper, cardstock

 **Note**

r Default:

- Paper Type: *No Display*
- Copying Method in Duplex: *2 Sided Copy*
- Apply Auto Paper Select: *Yes*

r When paper of the same type and size is loaded in two different paper trays and you want to specify one as 2 Sided Copy and one as 1 Sided Copy, specify the upper tray for 2 Sided Copy. If one of the trays is specified as the default in Paper Tray Priority, assign 2 Sided Copy to that tray.

r A  appears next to the paper tray if [No] is selected in Auto Paper Select.

 **Limitation**

r [Auto Paper Select] can only be selected for the copier function if [No display] and [Recycled paper] are selected. If [No] is selected, Auto Paper Select is not valid for the tray.

v Paper Type: LCT

Sets the display so you can see what type of paper is loaded in the LCT.

- The paper types you can set are as follows:
 - recycled paper, special paper, colour paper, letterhead, preprinted paper, prepunched paper, bond paper, cardstock

Note

r Default:

- Paper Type: *No Display*
- Copying Method in Duplex: *2 Sided Copy*
- Apply Auto Paper Select: *Yes*

r A  appears next to the LCT if **[No]** is selected in Auto Paper Select.

Limitation

r **[Auto Paper Select]** can only be selected for the copier function if **[No display]** and **[Recycled paper]** are selected. If **[No]** is selected, Auto Paper Select is not valid for the LCT.

v Cover Sheet Tray

Allows you to specify and display the paper tray that is setting cover sheets. After selecting the paper tray, you can also specify the display timing and copy method for two-sided copying.

Note

r Default:

- Tray to Program: *Off*

r Functions using the cover sheet tray setting are the front cover function and front/back cover function.

r When **[At Mode Selected]** is selected, cover sheet tray settings only appear when the cover function or slip sheet function is selected.

r When **[Full Time]** is selected, the cover sheet tray is always displayed.

r You can set Copying Method in Duplex only when **[At Mode Selected]** is selected.

Reference

“Covers”, *Copy Reference*

v Slip Sheet Tray

Allows you to specify and display the paper tray that is inserting slip sheets. After selecting the paper tray, you can also specify the display timing and copy method for two-sided copying.

Note

r Default:

- Tray to Program: *Off*

r When **[At Mode Selected]** is selected, slip sheet tray settings only appear when the cover function or slip sheet function is selected.

 **Reference**

"Slip Sheets", *Copy Reference*

Timer Settings

v Auto Off Timer

After a specified period has passed, following job completion, the machine automatically turns off, in order to conserve energy. This function is called "Auto Off".

The machine status after the Auto Off operation is referred to as "Off mode", or "Sleep mode". For the Auto Off Timer, specify the time to elapse before Auto Off.

 **Note**

r Default: *1 minute(s)*

r The time can be set from 10 seconds to 240 minutes, using the number keys.

r From "Off mode" or "Sleep mode", the machine is ready to use within 10 seconds (Type 1), and 15 seconds (Type 2) respectively.

r Auto Off may not work when error messages appear.

v Panel Off Timer

Set the amount of time the machine waits before switching the panel off after copying has finished or performing the last operation.

 **Note**

r Default: *1 minute(s)*

r The time can be set from 10 seconds to 240 minutes, using the number keys.

v System Auto Reset Timer

The System Reset setting automatically switches the screen to that of the function set in Function Priority when no operations are in progress, or when an interrupted job is cleared. This setting determines the system reset interval. See p.51 "Function Priority".

 **Note**

r Default: *ON, 60 seconds*

r The time can be set from 10 to 999 seconds in 1 second increments, using the number keys.

v Copier/Document Server Auto Reset Timer (copier/Document Server)

Specifies the time to elapse before copier and Document Server modes reset.

 **Note**

r If [OFF] is selected, the machine does not automatically switch to the user code entry screen.

r Default: *ON, 60 seconds*

r The time can be set from 10 to 999 seconds, using the number keys.

v Facsimile Auto Reset Timer (facsimile)

Specifies the time to elapse before the facsimile mode resets.

 Note

r Default: *30 seconds*

r The time can be set from 30 to 999 seconds, using the number keys.

v Scanner Auto Reset Timer (scanner)

Specifies the time to elapse before the scanner function resets.

 Note

r If **[OFF]** is selected, the machine will not automatically switch to the user code entry screen.

r Default: *ON, 60 seconds*

r The time can be set from 10 to 999 seconds, using the number keys.

v Set Date

Set the date for the copier's internal clock using the number keys.

 Note

r To change between year, month, and day, press [**←**] and [**→**].

v Set Time

Set the time for the copier's internal clock using the number keys.

 Note

r To change between hours, minutes and seconds, press [**←**] and [**→**].

r Enter the time using the 24-hour format (in 1 second increments).

Key Operator Tools

The key operator must set the following items. For settings or more information, contact the key operator.

The key operator is recommended to program an access code when performing the settings. See p.60 “Key Operator Code”.

v User Code Management

Allows you to control who uses the machine by setting codes for users.

User codes must be registered for user code management. See p.70 “User Code”.

 Note

r Default: *Copier/OFF, Document Server/OFF, Facsimile/OFF, Scanner/OFF, Printer/Auto Program*

r By using Auto Program for the printer, you can keep a print log for each user code entered from the driver.

v Key Counter Management

Use the key counter to specify whether users are restricted or not.

Note

r Default: *Copier/OFF, Document Server/OFF, Facsimile/OFF, Scanner/OFF, Printer/OFF*

v External Charge Unit Management

Use the external charge unit to manage usage charges.

Note

r Default: *Copier/OFF, Document Server/OFF, Facsimile/OFF, Scanner/OFF, Printer/OFF*

v Key Operator Code

Specifies whether or not to use passwords (max. eight digits) to control Key Operator Tools settings for access codes.

Note

r Default: *OFF*

r If you select **[ON]**, enter the access code (max. eight digits) using the number keys, and then select **[Partial]** or **[All Initial Settings]** to set the access limit.

- If you selected **[Partial]**

An access code is only required for the Timer Settings, Key Operator Tools for System Settings, and Key Operator Tools for Facsimile Features. **[Menu Protect]** can be set for **[Maintenance]** in Printer Features. If you set **[Menu Protect]**, you can set the key operator code for some Printer Features. See "Printer Features Parameters", *Printer Reference 2*.

- If you selected **[All Initial Settings]**:

An access code is required to access all items in System Settings, Copier/Document Server Features, Facsimile Features, Printer Features, and Scanner Features.

r If you select **[All Initial Settings]**, you must enter an access code to access the Key Operator Code display.

v Extended Security

Specify whether or not to use the security function.

Note

r Default : *Off*

r You have to set a 6-digit key operator code to enable Extended Security. See p.60 "Key Operator Code".

r When the Extended Security function is on, a security mark  appears on the left side of the date, in the upper right of the display panel.

Reference

For details about security, see p.149 "Security".

v Display/Print Counter

Allows you to view and print the number of prints.

- Display/Print Counter
Displays the number of prints for each function (Total, Copier, Facsimile, Printer, A3/DLT, Duplex, and Staple).
- Print Counter List
Prints out a list of the number of prints made under each function.
- To print the counter list:
 - ① Press the **[User Tools/Counter]** key.
 - ② Press **[System Settings]**.
 - ③ Press **[Key Operator Tools]**.
 - ④ Press **[Display/Print Counter]**.
 - ⑤ Press **[Print Counter List]**.



- ⑥ Press the **[Start]** key.
- ⑦ Press **[Exit]**.

v Display/Clear/Print Counter per User Code

Allows you to view and print the numbers of prints accessed with user codes, and to set those values to 0.

Note

- r Press **[▲]** and **[▼]** to show all the numbers of prints.
- r The number of prints may differ from the counter value shown in Display/Print Counter.
 - Print counter per user code
Prints the number of prints made under each user code.
 - Clear counter per user code
Sets the number of prints made under each user code to 0.

Note

- r Print list for each user code, see p.74 “Printing the Number of Prints for Each User Code”.
 - Print counter for all user codes
Prints the number of prints made under all user codes.
 - Clear counter for all user codes
Sets the number of prints made under all user codes to 0.

v **Print Address Book: Destination List**

You can print the destination list registered in the Address Book.

- **Print in Title 1 Order**
Prints the Address Book in Title 1 order.
- **Print in Title 2 Order**
Prints the Address Book in Title 2 order.
- **Print in Title 3 Order**
Prints the Address Book in Title 3 order.
- **Print Group Dial List**
Prints the group Address Book.

- ① Select the print format.
- ② To print the list on two-sided pages, select **[Print on 2 Sides]**.
- ③ Press the **[Start]** key.
The list prints out.

v **Address Book Management**

You can add, change, or delete user information in the Address Book, and facsimile/scanner functions destinations.

For details about these operations, see p.70 “User Code”, p.76 “Fax Destination”, and p.82 “E-mail Destination”.

- **[Program/Change]**
This registers new user codes. You can register and change the items below:
 - **User name**
User (destination) name, key display, registration number, title selection
 - **User code**
User code, available functions
 - **Fax Dest.**
Facsimile number, international TX mode, fax header, label insertion
 - **E-mail**
E-mail address, sender registration
 - **Folder**
Protocol, path, user name, password, port no., server name
 - **Protect dest.**
Sender's name, folder, protection code
- **[Delete]**
Deletes a user.

Note

- r You can register up to 100 user codes. If you add the optional user account enhance unit, you can register up to 500 user codes.
- r You can also register and manage data in the Address Book, using Smart-NetMonitor for Admin (printer option required).
- r You can also register and manage data in the Address Book using a Web browser. See the Web browser's Help.

v Address Book: Program/Change/Delete Group

You can register multiple users in a group.

This allows you to easily control registered users in each group.

For details about operations, see p.95 “Registering Destinations to a Group”.

- **[Program/Change]**

This registers new groups, or changes the group name, key display, title selection, registration number or protection code. You can also protect folders.

- **[Delete]**

Deletes a group.

Note

r You can register up to 100 groups.

r You can also group users (destinations) using a Web browser. See the Web browser's Help.

v Address Book: Program/Change/Delete Transfer Request

You can register fax destinations for the Transfer Request function in facsimile mode.

For details about operations, see p.98 “Registering the Transfer Request”.

- **[Program/Change]**

This registers new transfer requests and receiving stations, or changes the transfer request name, key display, title selection, registration number, fax destination, or e-mail address.

- **[Delete]**

Deletes a transfer request.

Note

r You can register up to 100 transfer requests.

v Address Book: Change Order

Changes the order of registered users (destinations).

Note

r You can rearrange the order of items on the same page, but you cannot move items to another page. For example, you cannot move an item from “PLANNING” ([OPQ]) to “DAILY” ([CD]).

- ① Press the **[User Tools/Counter]** key.
- ② Press **[System Settings]**.
- ③ Press **[Key Operator Tools]**, and then press **[▼Next]**.
- ④ Press **[Address Book: Change Order]**.



- ⑤ Press the user (destination) key you want to move.



Note

r You can select a user using the number keys.

- ⑥ Press the user (destination) key that is in the place you want to move to.



The user (destination) moves to the selected place, and the other users' keys will shift also.



Note

r You can select a user using the number keys.

v **Address Book: Edit Title**

You can edit the title to easily find a user.

- ① Press the [User Tools/Counter] key.
- ② Press [System Settings].
- ③ Press [Key Operator Tools], and then press [▼Next].
- ④ Press [Address Book: Edit Title].



- ⑤ Press the title key you want to change.



- ⑥ Enter the new name, and then press **[OK]**.
- ⑦ Press **[Exit]**.

v **Address Book: Select Title**

Specifies the title to select a user.

Note

r Default: *Title 1*

v **Auto Delete File**

Specifies whether documents stored in the Document Server are to be deleted or not after a specified period of time elapses.

Note

r Default: *Yes After 3 day(s)*

r If you select **[Yes]**, documents stored subsequently are deleted after the specified period.

r If you select **[No]**, documents are not automatically deleted.

r If you select **[Yes]**, enter a number of days from 1 to 180 (in 1 day increments).

r The default is 3 days, this means documents are deleted 3 days (72 hours) after they are stored.

v **Delete All Files**

Deletes all documents stored in the Document Server.

Note

r Even if a password is always set, all documents are deleted.

r A confirmation message appears. To delete all documents, select **[OK]**.

v **Password Management for Stored Files**

- Unlocking a locked document

When a document is locked due to a wrong password being entered, this function unlocks the document, allowing access.

- Temporarily disabling document security

Password-protected documents can be temporarily accessed, without entering the password.

Note

r Default: *Do not Unlock*

r Select **[Unlock]** only when you forget the password. After accessing the document, be sure to select **[Do not Unlock]**.

Reference

p.151 “Unlocking a locked document”

p.151 “Temporarily Disabling Document Security”

v **AOF (Always ON)**

Specify whether or not to use Auto Off.

 **Note**

r Default: *ON*

v **Program/Change LDAP Server**

Programming an LDAP server allows you to look up e-mail destinations from the LDAP server Address Book directly. This function is available when you send scan files by e-mail in scanner mode.

You can program and change the identification name, server name, search base, port no., authentication, user name, password, and search options.

 **Reference**

For details about these operations, see p.102 “Programming/Changing LDAP Server”.

v **Use LDAP Server**

Specify whether or not to use the LDAP server.

 **Note**

r Default: *OFF*

r If you select **[OFF]**, **[Search LDAP]** will not appear on the searching display.

Address Book

Registering user information, such as fax number and e-mail address, in the Address Book allows you to manage them together.

Important

r Address Book data is stored on the hard disk. It can be lost if there is some kind of hard disk failure. The manufacturer shall not be responsible for any damage resulting from data loss.

Note

r Using [Address Management Tool] in SmartNetMonitor for Admin, you can backup Address Book data. We recommend backing up data when using the Address Book.

Reference

For details about SmartNetMonitor for Admin and how to install it, see *Printer Reference 1*.

For operating instructions, see SmartNetMonitor for Admin Help.

You can register and manage the following items in the Address Book:

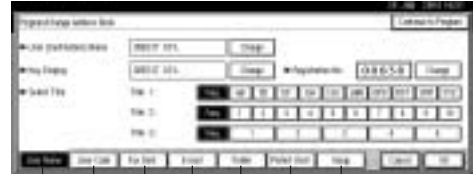

v To manage registered items

1. User Code

Register user codes to restrict particular functions to certain users, and check their use of each function.

Reference

p.70 "User Code"

2. Protect Dest.

Reference

p.69 "When using the scanner function"

p.69 "Registering Sender Information"

3. Group

Use this to display the group that the selected user (destination) belongs to.

You can group registered fax destinations, e-mail destinations, and folders to manage them better. For details about operations, see p.95 "Registering Destinations to a Group".

v Items to register

4. User Name

Reference

p.68 "Registering the destination name and key display"

p.69 "Registering Sender Information"

5. Fax Dest.

 Reference

p.68 “When using the fax function”



6. E-mail

 Reference

p.68 “When using the fax function”

p.69 “When using the scanner function”

p.69 “Registering Sender Information”



7. Folder

 Reference

p.69 “When using the scanner function”

- SMB



- FTP



Registering Destination Information

v Registering the destination name and key display

- User Name
Register the destination name and key display name. This is the basic information required for managing destinations.

 Reference

p.70 “User Code”

v When using the fax function

- Fax Dest.
Register fax numbers in the Address Book. To send a fax, select the destination key as it appears on the initial fax function display, so you can specify the fax number. When you set Label Insertion to ON, the registered destination name, preceded by “To”, is printed at the top of the page when it is received at the other end.

 Reference

p.76 “Fax Destination”

- E-mail
Register e-mail addresses in the Address Book. To send an Internet Fax, select the destination key as it appears on the initial fax function display, so you can specify the e-mail address.

 Reference

p.82 “E-mail Destination”

v When using the scanner function

- E-mail
Register e-mail addresses in the Address Book. To send a scan file by e-mail, select the destination key as it appears on the initial scanner function display, so you can specify the e-mail address.

Reference

p.82 “E-mail Destination”

- Folder
Register the path name, user name, and password. To send files directly to shared folders, select the destination key as it appears on the initial scanner function display, so you can specify the folder.
Select SMB when sending files to shared Windows folders.
Select FTP when uploading files to an FTP server.

Reference

p.85 “Registering Folders”

You can stop unauthorized users accessing folders from the machine by setting a protection code.

Reference

p.93 “Registering a Protection Code”

Registering Sender Information

v When using the scanner function

You can set Register as Sender to ON for an e-mail address. If you do this, you can use it as the sender address when sending scan files by e-mail.

- User Name
Register the user name and key display name. This is useful when selecting the sender from the Attach Sender's Name list.
Register the user name so it will be recorded under Sender in Scanned Files Status. Also, the user name automatically appears in the From field of the e-mail.

Reference

p.70 “User Code”

- E-mail
Register the e-mail address. You can use it as the sender address when sending scan files by e-mail using the scanner function. Also, the sender address automatically appears in the From field of the e-mail.
To display a user key on the Attach Sender's Name list, you must register an e-mail address to it.

Reference

p.82 “E-mail Destination”

You can prevent misuse of sender name by setting a protection code on the e-mail address.

Reference

p.93 “Registering a Protection Code”

User Code

Register user codes to restrict the following functions to certain users, and check their use of each function:

- Copier
- Document Server
- Facsimile
- Scanner
- Printer

 **Note**

- r The number of copies made of documents using the fax function stored in the Document Server is counted for each user code. This allows you to check each user's usage.
- r The number of copies scanned in using the scanner function is counted for each user code. This allows you to check each user's usage.
- r To automatically register the printer driver user code, select **[Auto Program]** for the printer in User Code Management. To use the user code set in User Tools, select **[ON]**. Set the user codes registered in User Tools for the printer driver. See p.59 "User Code Management".

 **Reference**

For details about setting user codes for the printer driver, see *Printer Reference 1* or the printer driver Help.

 **Important**

- r The functions associated with each user code are the same. If you change or delete user codes, management data and limits associated with that code become invalid.

Registering a New User Code

1 Press the **[User Tools/Counter]** key.



2 Press **[System Settings]**.



3 Press **[Key Operator Tools]**, and then press **[▼Next]**.

4 Press **[Address Book Management]**.

5 Press **[New Program]**.

 **Note**

- r To assign a user code to a registered user, press the user (destination) key whose user code is to be registered, or enter the registered number using the number keys.

6 Set the user information.

 **Note**

- r To register a user code to a registered user, proceed to step **7**.

To register the user name and key display

A Press **[Change]** on the right of the user name or key display.

The user name or key display entry display appears.

- B** Enter the user name or key display, and then press [OK].

 **Note**

- r You can use the same user name as that assigned to the documents using the Document Server function. For this, the user code is not necessary. See p.33 “Document Server”.

 **Reference**

p.147 “Entering Text”

To select the title

- A** Press the key for the classification you want to use under Select Title.

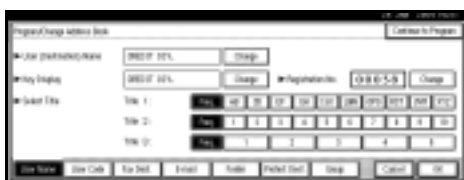

 **Note**

- r The keys you can select are as follows:
- [Freq.]... Added to the page that is displayed first.
 - [AB],[CD],[EF],[GH],[IJK],[LMN],[OPQ],[RST],[UVW],[XYZ], [1] to [10]... Added to the list of items in the selected title.
- r You can select [Freq.], and one more page for each title.

- 7** Press [User Code].

- 8** Enter the user code using the number keys, and then press [#].



 **Note**

- r If you make a mistake, press [Clear] or the [Clear/Stop] key, and then enter the code again.

- 9** Select the functions to be used with the user code from Available Functions.

- 10** To continue registering user codes, press [Continue to Program], and then repeat the procedure from step 6.



- 11** Press [OK].

- 12** Press [Exit].

- 13** Press the [User Tools/Counter] key.

Changing a User Code

Note

Even if you change a user code, the counter value will not be cleared.

- 1** Press the [User Tools/Counter] key.
- 2** Press [System Settings].
- 3** Press [Key Operator Tools], and then press [▼Next].
- 4** Press [Address Book Management].

5 Select the registered user code you want to change.

Press the user (destination) key, or enter the registered number using the number keys.

Note

If you press , you can search for a user by user name/index, user code, fax destination, or e-mail address.

6 Enter the new information for the item you want to change.

To change the user (destination) name or key display

- A** Press [Change] on the right of the user (destination) name or key display.
- B** Enter the user (destination) name, and then press [OK].

Reference

p.147 "Entering Text"

To change the title

- A** Press the key for the classification you want to use from Select Title.

Changing the user code

- A** Press [User Code].
- B** Press [Change], and then enter the new user code using the number keys.



- C** Press [#].

To change the available functions

- A** Press [User Code].
- B** Press the key to select the functions to enable.

Note

Press the key to highlight it, and then the function is enabled.

- 7** Press [OK].
- 8** Press [Exit].
- 9** Press the [User Tools/Counter] key.

Deleting a User Code

Important

r This operation also deletes user codes registered to multiple functions. User control via the deleted user code is disabled.

- 1** Press the [User Tools/Counter] key.
- 2** Press [System Settings].
- 3** Press [Key Operator Tools], and then press [▼Next].
- 4** Press [Address Book Management].

To delete the user code

A Select the user (destination) whose code is to be deleted.

Press the user (destination) key, or enter the registered number using the number keys.

- B** Press [User Code].
- C** Press [Change] to delete the user code, and then press [#].



- D** Press [OK].

To delete a user (destination)

- A** Press [Delete].
- B** Select a user (destination) you want to delete.

Press the user (destination) key, or enter the registered number using the number keys.

Note

r If you press , you can search for a user by user name/index, user code, fax destination, or e-mail address.

- C** Press [Yes] in the confirmation screen.

- 5** Press [Exit].

- 6** Press the [User Tools/Counter] key.

Displaying the Number of Prints for Each User Code

You can check the number of prints made under each function's user code.

- 1** Press the [User Tools/Counter] key.
- 2** Press [System Settings].
- 3** Press [Key Operator Tools].
- 4** Press [Display/Clear/Print Counter per User Code].
- 5** Select [Print Counter], [Transmission Counter] or [Scanner Counter].

Counters for individual function usage under each user code appear.

Printing the Number of Prints for Each User Code

You can print out the number of prints made under each user code using [Print Counter], [Transmission Counter] or [Scanner Counter].

To print the number of prints made under each user code

- 1 Press the [User Tools/Counter] key.
- 2 Press [System Settings].
- 3 Press [Key Operator Tools].
- 4 Press [Display/Clear/Print Counter per User Code].
- 5 Select a user code from the left side of the display.

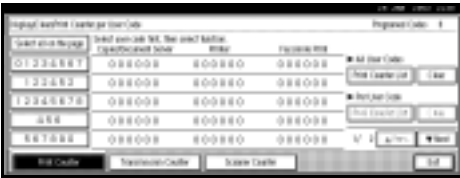

Note
 r Press [Select all on the page] to select all user codes on the page.

- 6 Press [Print Counter List] under Per User Code.

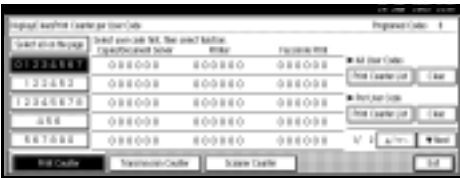

Note
 r Enter the user code, and then press [#] if the user code is registered.

- 7 Select the function usage you want to print from [Print Counter], [Transmission Counter], and [Scanner Counter].

- 8 Press [Print].

To print the number of prints for all user codes

- 1 Press the [User Tools/Counter] key.
- 2 Press [System Settings].
- 3 Press [Key Operator Tools].
- 4 Press [Display/Clear/Print Counter per User Code].
- 5 Press [Print Counter List] under All User Codes.

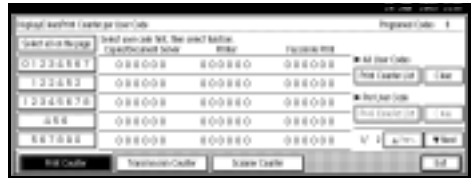

Note
 r Enter the user code, and then press [#] if the user code is registered.

- 6 Select the function usage you want to print from [Print Counter], [Transmission Counter], and [Scanner Counter].

- 7 Press [Print].

Clearing the Number of Prints

- 1 Press the [User Tools/Counter] key.
- 2 Press [System Settings].
- 3 Press [Key Operator Tools].
- 4 Press [Display/Clear/Print Counter per User Code].
- 5 Select the user code to clear.

To clear the number of prints made under a user code

A Select the user code from the left side of the display.

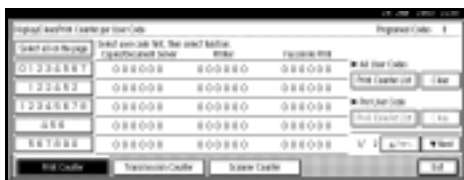

Note

- r Press [Select all on the page] to select all user codes on the page.

B Press [Clear] under Per User Codes.

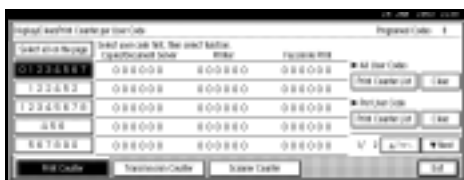

C Select the function usage you want to clear from [Print Counter], [Transmission Counter], and [Scanner Counter].

D Press [OK].

To clear the number of prints for all user codes

A Press [Clear] under All User Codes.

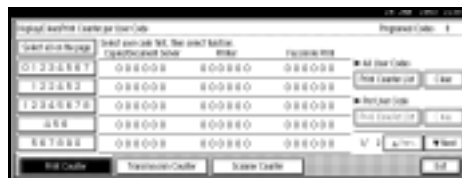

B Select the function usage you want to clear from [Print Counter], [Transmission Counter] and [Scanner Counter].

C Press [OK].

Fax Destination

Register a fax destination so you do not need to enter fax numbers each time, and can send documents scanned in using the fax function.

- It is easy to select the fax destination if you register a “User (Destination) Name” and “Key Display” for the fax destination.
- You can register fax destinations as a group.

You can program the following items in a fax destination:

v Fax number

Registers the destination's fax number. You can enter a fax number using up to 128 digits. You must include every digit in the number.

v SUB Code

Registering a SUB Code allows you to use Confidential Transmission to send messages to the other fax machines which support a similar function called “SUB Code”. You can also program an SID Code (Sender ID) under this function. A code can be up to 20 digits long.

v SEP Code

Registering a SEP Code allows you to use Polling Reception to receive faxes from the other fax machines which support Polling Reception. You can also program a PWD Code when you want to use a password under this function. A code can be up to 20 digits long.

v Line

If the optional extra G3 interface unit is installed, you can select the line type per destination.

v Fax header

You can select to print a fax header on fax messages the other party receives. The default is “1st Name”. See *Facsimile Reference <Advanced Features>*.

v Label insertion

With this function you can have the receiver's name printed on the message when it is received at the other end. The name is printed at the top of the page and will be preceded by “To”. You can also have a standard message stamped on the second and third lines after that.

Note

- r Fax header and label insertion are also printed when sending by e-mail using fax functions.
- r You can program a standard message apart from one of those registered in the machine. See “Programming, Changing, and Deleting Standard Messages”, *Facsimile Reference <Advanced Features>*.

v International TX mode

When setting the International TX mode to [ON], the machine transmits more carefully by lowering transmission speed. However, communication times increase.

Registering a Fax Destination

- 1 Press the [User Tools/Counter] key.

Zcas100e.eps



- 2 Press [System Settings].



- 3 Press [Key Operator Tools], and then press [▼Next].

- 4 Press [Address Book Management].

- 5 Press [New Program].

Note

- r To register a fax destination to a registered user, press the user (destination) key, or enter the registered number using the number keys.

- 6 Set the user's information.

Note

- r To register a fax destination to a registered user, proceed to step 7.

To register the user (destination) name and key display

- A Press [Change] under User (Destination) Name or Key Display.

The user (destination) name or key display entry display appears.

- B Enter the user (destination) name or key display, and then press [OK].

Note

- r You can use the user name when selecting a fax destination.
- r You can register the user code after the user name. For details, see p.70 "User Code".

Reference

p.147 "Entering Text"

To select the title

- A To associate a user with a title, press the title key under Select Title.

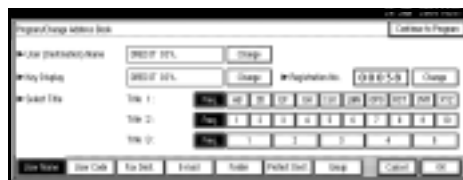

Note

- r The keys you can select are as follows:
 - [Freq.]... Added to the page that is displayed first.
 - [AB], [CD], [EF], [GH], [IJK], [LMN], [OPQ], [RST], [UVW], [XYZ], [1] to [10]... Added to the list of items in the selected title.

- r You can select [Freq.], and one more page for each title.

- 7 Press [Fax Dest.].

8 Enter the fax number using the number keys, and then press [OK].



To select the line

- A Press [Select Line].
- B Select the line, and then press [OK].

To program the SUB Code

- A Press [Adv. Features], and then select [SUB Code].
- B Press [Change] under TX SUB Code.
- C Enter a SUB Code using the number keys, and then press [OK].
- D To enter a password, press [Change] under Password (SID).
- E Enter a password using the number keys, and then press [OK].
- F Press [OK].

To program the SEP Code

- A Press [Adv. Features], and then select [SEP Code].
- B Press [Change] under RX SEP Code.
- C Enter a SEP Code using the number keys, and then press [OK].
- D To enter a password, press [Change] under Password (PWD).

- E Enter a password using the number keys, and then press [OK].
- F Press [OK].

To set the International TX mode

- A Press [Change] under International TX Mode.
- B Select [OFF] or [ON], and then press [OK].

To select the fax header

Note

r You can register the fax header name in Program Fax Information under the system settings of Facsimile Features. See *Facsimile Reference <Advanced Features>*.

- A Press [Change] under Fax Header.
- B Select [1st Name] or [2nd Name], and then press [OK].

To set label insertion

When Label Insertion is set to ON, the receiver's name and standard messages are printed on the fax message when it is received at the other end.

- A Press [Change] under Label Insertion.
- B Select [ON].
- C Press [Change] under Line 2.

- D Select a standard message to print on the second line. To stamp a customized message, press [Custom Message].

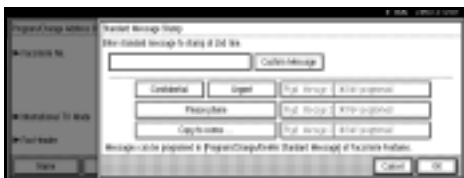

- E Enter a message, and then press [OK].

Reference

p.147 "Entering Text"

- F Press [OK].

- G Press [Change] under Line 3.

- H Select a standard message, and then press [OK].

- I Press [OK].

- 9** Press [OK].

Note

- r When a group is registered, you can add this fax destination to the group. See p.95 "Registering Destinations to a Group".

Changing a Registered Fax Destination

- 1** Press the [User Tools/Counter] key.

- 2** Press [System Settings].

- 3** Press [Key Operator Tools], and then press [▼Next].

- 4** Press [Address Book Management].

- 5** Select the registered fax destination user you want to change.

Press the user (destination) key, or enter the registered number using the number keys.

Note

- r If you press , you can search for a user by user name/index, user code, fax destination, or e-mail address.

- 6** Press [Fax Dest.].

- 7** Enter the items.

To change the fax number

- A Press [Change] under Facsimile No..



- B Enter the new fax number using the number keys, and then press [OK].

To change the line

- A Press [Select Line].

- B Select the line type.

- C Press [OK].

To change the SUB Code

- A Press [Adv. Features].
- B Press [Change] under TX SUB Code.
- C Enter the new SUB Code, and then press [OK].
- D To change the password, press [Change] under Password (SID).
- E Enter the new password, and then press [OK].
- F Press [OK].

To change the SEP Code

- A Press [Adv. Features].
- B Press [Change] under RX SEP Code.
- C Enter the new SEP Code, and then press [OK].
- D To change the password, press [Change] under Password (PWD).
- E Enter the new password, and then press [OK].
- F Press [OK].

To change the fax header

- A Press [Change] under Fax Header.
- B Select the fax header, and then press [OK].

To change the label insertion

- A Press [Change] under Label Insertion.
- B Press [Change] under Line 2.

- C Select the new standard message, or press [Custom Message] to enter the new message.
- D Press [OK].
- E Press [Change] under Line 3.
- F Select the new standard message, and then press [OK].
- G Press [OK].

8 Press [OK].

 **Note**

- r To change the user name, see p.72 “To change the user (destination) name or key display”.

Deleting a Registered Fax Destination

Note

- r If you delete a destination that is a specified delivery destination, messages to its registered Personal Box, for example, cannot be delivered. Be sure to check the settings in the fax function before deleting any destinations.

- 1** Press the **[User Tools/Counter]** key.
- 2** Press **[System Settings]**.
- 3** Press **[Key Operator Tools]**, and then press **[▼Next]**.
- 4** Press **[Address Book Management]**.

To delete only the fax number

- A Select the fax destination you want to delete.**

Press the user (destination) key, or enter the registered number using the number keys.

- B Press [Fax Dest.].**
- C Press [Change] under Facsimile No..**
- D Press [Delete All], and then press [OK].**



- E Press [OK].**

To delete all user information

- A Press [Delete].**
- B Select a user you want to delete.**

Press the user (destination) key, or enter the registered number using the number keys.

- C Press [Yes].**

- 5 Press [Exit].**

Note

- r To delete user codes together, see p.73 “Deleting a User Code”.

- 6 Press the [User Tools/Counter] key.**

E-mail Destination

Register e-mail destinations so you do not need to enter e-mail address every time, and can send scan files by e-mail, or send fax documents by Internet Fax.

- It is easy to select the e-mail destination if you register “User (Destination) Name” and “Key Display” for the e-mail destination.
- You can register e-mail destinations as a group.
- You can use the e-mail address as the sender address when sending scan files in scanner mode. If you do this, set a protection code on the sender address to prevent use by other people. See p.93 “Registering a Protection Code”.
- You can select an e-mail address from an LDAP server, and then register it in the Address Book. For details about programming an LDAP server, see p.102 “Programming/Changing LDAP Server”. For details about searching an e-mail address from an LDAP server, see “Sending Scan File by E-mail”, *Scanner Reference*.

Registering an E-mail Destination

- 1 Press the [User Tools/Counter] key.



- 2 Press [System Settings].

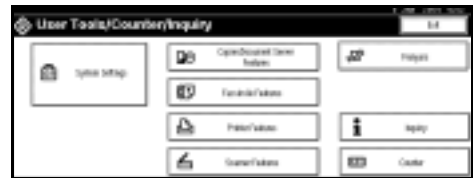

- 3 Press [Key Operator Tools], and then press [▼Next].

- 4 Press [Address Book Management].

- 5 Press [New Program].

Note

- r To register an e-mail address to a registered user, press the user (destination) key, or enter the registered number using the number keys.

- 6 Set the user's information.

Note

- r To register an e-mail address to a registered user, proceed to step 7.

To register the user (destination) name and key display

- A Press [Change] under User (Destination) Name or Key Display.

The user (destination) name or key display entry display appears.

- B Enter the user (destination) name or key display, and then press [OK].

 **Note**

- r You can use the user name when selecting an address to send an e-mail to.
- r You can register the user code after the user name. For details, see p.70 “User Code”.

 **Reference**

p.147 “Entering Text”

To select the title

- A To associate a user with a title, press the title key under Select Title.



 **Note**

- r The keys you can select are as follows:
 - [Freq.]... Added to the page that is displayed first.
 - [AB], [CD], [EF], [GH], [IJK], [LMN], [OPQ], [RST], [UVW], [XYZ], [1] to [10]... Added to the list of items in the selected title.
- r You can select [Freq.], and one more page for each title.

- 7** Press [E-mail].

- 8** Press [Change] under E-mail Address.



- 9** Enter the e-mail address.

Entering the e-mail address

- A Enter the e-mail address.



- B Press [OK].

Using the e-mail address as the sender

- A Press [ON] under Register as Sender.

- 10** Press [OK].

 **Note**

- r When a group is registered, other e-mail destinations can be added to the group. See p.96 “Registering Destinations to a Group”.

Changing a Registered E-mail Destination

- 1** Press the [User Tools/Counter] key.
- 2** Press [System Settings].
- 3** Press [Key Operator Tools], and then press [▼Next].
- 4** Press [Address Book Management].
- 5** Select the registered e-mail address user you want to change.

Press the user (destination) key, or enter the registered number using the number keys.

Note

r If you press , you can search for a user by user name/index, user code, fax destination, or e-mail address.

- 6** Press [E-mail].
- 7** Enter the items.

To change the e-mail address

- A** Press [Change] under E-mail Address.



- B** Enter the e-mail address, and then press [OK].

 **Reference**
p.147 "Entering Text"

- 8** Press [OK].

Note

r To change the user name, see p.72 "To change the user (destination) name or key display".

Deleting a Registered E-mail Destination

- 1** Press the [User Tools/Counter] key.
- 2** Press [System Settings].
- 3** Press [Key Operator Tools], and then press [▼Next].
- 4** Press [Address Book Management].

To delete only the e-mail address

- A** Select the e-mail address user you want to delete.

Press the user (destination) key, or enter the registered number using the number keys.

- B** Press [E-mail].
- C** Press [Change] under E-mail Address.
- D** Press [Delete All], and then press [OK].
- E** Press [OK].

To delete all user information

- A** Press [Delete].
- B** Select a user you want to delete.

Press the user (destination) key, or enter the registered number using the number keys.

- C** Press [Yes].

- 5** Press [Exit].

Registering Folders

By registering a shared folder, you can send scan files to it directly.

There are two types of protocol you can use:

- **SMB**
For sending files to shared Windows folders
- **FTP**
For uploading files to an FTP sever

Note

- r For details about protocols, server names, and folder levels, ask your network administrator.
- r You can stop unauthorized users accessing folders from the machine. See p.93 “Registering a Protection Code”.
- r You can only select either SMB or FTP. If you change protocol after finishing your settings, all previous entries are cleared.
- r You can register up to 50 folders per group. Files cannot be sent to a group with over 50 folders registered.

Reference

For details about network settings, see *Network Guide*.

For details about Scan to Folder, see *Scanner Reference*.

Using SMB to Connect

Note

- r To register a folder in an FTP server, see p.89 “Using FTP to Connect”.

To register an SMB folder

- 1** Press the [User Tools/Counter] key.



- 2** Press [System Settings].



- 3** Press [Key Operator Tools], and then press [▼Next].

- 4** Press [Address Book Management].

- 5** Press [New Program].

Note

- r To register a folder to a registered user, press the user (destination) key, or enter the registered number using the number keys.

6 Set the user's information.

Note

- r To register a folder to a registered user, proceed to step **7**.

To register the user (destination) name and key display

A Press [Change] under User (Destination) Name or Key Display.

The user (destination) name or key display entry display appears.

B Enter the user (destination) name or key display, and then press [OK].

Note

- r You can use the user name as the folder name.
- r You can register the user code after the user name. For details, see p.70 "User Code".

Reference

p.147 "Entering Text"

To select the title

A To associate a user with a title, press the title key under Select Title.



Note

- r The keys you can select are as follows:
 - [Freq.]... Added to the page that is displayed first.

- [AB], [CD], [EF], [GH], [IJK], [LMN], [OPQ], [RST], [UVW], [XYZ], [1] to [10]... Added to the list of items in the selected title.

- r You can select [Freq.], and one more page for each title.

7 Press [Folder].

8 Press [SMB].

Note

- r To specify a folder, you can either enter the path manually, or locate the folder by browsing the network.

Reference

p.86 "To locate the folder manually"

p.87 "Using Browse Network to locate the folder"

To locate the folder manually

A Press [Change] under Path.



B Enter the path where the folder is located.

Note

- r Enter the path using this format: "\\ServerName\ShareName\PathName".
- r You can also enter an IP address.
- r You can enter a path using up to 128 characters.

Changing a registered SMB folder

- 1** Press the [User Tools/Counter] key.
- 2** Press [System Settings].
- 3** Press [Key Operator Tools], and then press [▼Next].
- 4** Press [Address Book Management].
- 5** Select the user of the registered folder you want to change.

Press the user (destination) key, or enter the registered number using the number keys.

Note

r If you press , you can search for a user by user name/index, user code, fax destination, or e-mail address.

- 6** Press [Folder].
- 7** Select the items you want to change.

To change the protocol

- A** Press [FTP].



- B** A confirmation message appears. Press [Yes].

Note

r Changing the protocol will clear all settings made under the previous protocol.

- C** Enter each item again.

Reference

See steps 9 to 20 on p.89 “To register an FTP folder”.

Changing items under SMB

- A** Press [Change] under Path.
- B** Enter the new path where the folder is located, and then press [OK].

Note

r You can also use Browse Network to specify a new folder. For details, see p.87 “Using Browse Network to locate the folder”.

- C** Press [Change] under User Name.
- D** Enter the new user name, and then press [OK].

This is a user name which is authorized to access the folder.

- E** Press [Change] under Password.
- F** Enter the new password, and then press [OK].

- 8** Press [Connection Test] to check the path is set correctly.

- 9** Press [Exit].

Note

r If the connection test fails, check the settings, and then try again.

- 10** Press [OK].

Note

r To change the user (destination) name, see p.72 “Changing a User Code”.

Deleting a registered SMB folder

- 1** Press the [User Tools/Counter] key.
- 2** Press [System Settings].
- 3** Press [Key Operator Tools], and then press [▼Next].
- 4** Press [Address Book Management].

To delete only the registered folder

- A** Select a user of the folder you want to delete.

Press the user (destination) key, or enter the registered number using the number keys.

- B** Press [Folder].
C Press [FTP].

A confirmation message appears.

- D** Press [Yes].
E Press [OK].

Settings under SMB are all cleared.

To delete all user information

- A** Press [Delete].
B Select a user you want to delete.
 Press the user (destination) key, or enter the registered number using the number keys.
C Press [Yes].
5 Press [Exit].

Using FTP to Connect

 **Note**

- r To register a shared folder configured in Windows, see p.85 “Using SMB to Connect”.

To register an FTP folder

- 1** Press the [User Tools/Counter] key.



- 2** Press [System Settings].



- 3** Press [Key Operator Tools], and then press [▼Next].

- 4** Press [Address Book Management].

- 5** Press [New Program].

 **Note**

- r To register a folder to a registered user, press the user (destination) key, or enter the registered number using the number keys.

6 Set the user's information.

Note

- r To register a folder to a registered user, proceed to step **7**.

To register the user (destination) name and key display

A Press [Change] under User (Destination) Name or Key Display.

The user (destination) name or key display entry display appears.

B Enter the user (destination) name or key display, and then press [OK].

Note

- r You can use the user name as the folder name.
- r You can register the user code after the user name. For details, see p.70 "User Code".

Reference
p.147 "Entering Text"

To select the title

A To associate a user with a title, press the title key under Select Title.



Note

- r The keys you can select are as follows:
 - [Freq.]... Added to the page that is displayed first.

- [AB], [CD], [EF], [GH], [IJK], [LMN], [OPQ], [RST], [UVW], [XYZ], [1] to [10]... Added to the list of items in the selected title.

- r You can select [Freq.], and one more page for each title.

7 Press [Folder].

8 Press [FTP].

9 Press [Change] under Server Name.



10 Enter the server name.

Note

- r You can enter a server name using up to 64 characters.

11 Press [Change] under Path.

12 Enter the path.

Note

- r You can enter an absolute path, using this format: "/user/home/username"; or a relative path, using this format: "directory/sub-directory".
- r If you leave the path blank, the login directory is assumed to be the current working directory.
- r You can also enter an IP address.
- r You can enter a path using up to 128 characters.

13 Press [OK].

Note

- r To change the port number, press [Change] under Port No.. Enter the port number using the number keys, and then press [#]. You can enter 1 to 65535.

14 Press [Change] under User Name.

15 Enter the user name, and then press [OK].

Note

- r This is a user name which is authorized to access the folder.

16 Press [Change] under Password.

17 Enter the user's password, and then press [OK].

18 Press [Connection Test] to check the path is set correctly.

19 Press [Exit].

Note

- r If the connection test fails, check the settings, and then try again.

20 Press [OK].

Changing a registered FTP folder

1 Press the [User Tools/Counter] key.

2 Press [System Settings].

3 Press [Key Operator Tools], and then press [▼Next].

4 Press [Address Book Management].

5 Select the user of the registered folder you want to change.

Press the user (destination) key, or enter the registered number using the number keys.

Note

- r If you press , you can search for a user by user name/index, user code, fax destination, or e-mail address.

6 Press [Folder].

7 Select the items you want to change.

To change the protocol

A Press [SMB].



B A confirmation message appears. Press [Yes].

Note

- r Changing the protocol will clear all settings made under the previous protocol.

C Enter each item again.

Reference

See steps **8** to **11** on p.85 “To register an SMB folder”.

Changing items under FTP

A Press [Change] under Server Name.

B Enter the new server name, and then press [OK].

C Press [Change] under Path.

D Enter the new path, and then press [OK].

E Press [Change] under User Name.

F Enter the new user name, and then press [OK].

This is a user name which is authorized to access the folder.

G Press [Change] under Password.

H Enter the new password, and then press [OK].

 **Note**

r To change the port number, press [Change] under Port No.. Enter the new port number using the number keys, and then press [#].

8 Press [Connection Test] to check the path is set correctly.

9 Press [Exit].

 **Note**

r If the connection test fails, check the settings, and then try again.

10 Press [OK].

 **Note**

r To change the user (destination) name, see p.72 “Changing a User Code”.

Deleting a registered FTP folder

1 Press the [User Tools/Counter] key.

2 Press [System Settings].

3 Press [Key Operator Tools], and then press [▼Next].

4 Press [Address Book Management].

To delete only the registered folder

A Select a user of the folder you want to delete.

Press the user (destination) key, or enter the registered number using the number keys.

B Press [Folder].

C Press [SMB].

A confirmation message appears.

D Press [Yes].

E Press [OK].

Settings under FTP are all cleared.

To delete all user information

A Press [Delete].

B Select a user you want to delete.

Press the user (destination) key, or enter the registered number using the number keys.

C Press [Yes].

5 Press [Exit].

Registering a Protection Code

You can stop sender's names or folders being accessed by setting a protection code.

You can use this function to protect the following:

- Folders
You can prevent unauthorized access to folders.
- Sender's names (when sending e-mails)
You can prevent misuse of sender's names.

Note

- This function is not available when using Internet Fax to send e-mails.

Registering a Protection Code To a Single User

- 1 Press the [User Tools/Counter] key.



- 2 Press [System Settings].



- 3 Press [Key Operator Tools], and then press [▼Next].

- 4 Press [Address Book Management].

- 5 Press the user (destination) key you want to register a protection code to.

- 6 Press [Protect Dest.].



To protect the sender name

- A Press [Protect] under Sender's Name.



To protect the folder

- A Press [Protect] under Folder.

- 7 Press [Change] under Protection Code.

- 8 Enter a protection code using the number keys, and then press [#].

Note

- You can enter up to eight digits.

- 9 Press [OK].

- 10 Press [Exit].

Registering a Protection Code To a Group User

- 1** Press the [User Tools/Counter] key.
- 2** Press [System Settings].
- 3** Press [Key Operator Tools], and then press [▼Next].
- 4** Press [Address Book: Program/Change/Delete Group].
- 5** Press the group key you want to register a protection code to.
- 6** Press [Protect Dest.].

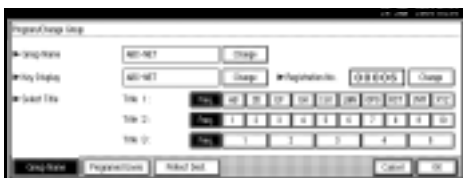

- 7** Press [Protect] under Folder.
- 8** Press [Change] under Protection Code.
- 9** Enter a protection code using the number keys, and then press [#].

 **Note**

r You can enter up to eight digits.

- 10** Press [OK].
- 11** Press [Exit].

Registering Destinations to a Group

Register destinations to a group to easily control registered fax, e-mail and folders for each group.

To group destinations, the groups must be registered beforehand.

Note

- r You can register up to 500 groups.
- r When using Scan to Folder function, you cannot send scan files to a group with over 50 folders registered.
- r You can set a protection code to prevent unauthorized access to the folders registered in a group. For details, see p.93 “Registering a Protection Code”.

Registering a New Group

- 1** Press the [User Tools/Counter] key.



- 2** Press [System Settings].



- 3** Press [Key Operator Tools], and then press [▼Next].

- 4** Press [Address Book: Program/Change/Delete Group].

- 5** Press [New Program].

- 6** Press [Change] under Group Name.



- 7** Enter the group name, and then press [OK].

The Key Display name sets automatically.

Reference

p.147 “Entering Text”

- 8** Press the desired title key under Select Title, if necessary.

Note

- r The keys you can select are as follows:

- [Freq.]... Added to the page that is displayed first.
- [AB], [CD], [EF], [GH], [IJK], [LMN], [OPQ], [RST], [UVW], [XYZ], [1] to [10]... Added to the list of items in the selected title.

- r You can select [Freq.], and one more page for each title.

- 9** When you want to change the key display, press [Change] under Key Display. Enter the key display, and then press [OK].

- 10** Press [OK].

Registering Destinations to a Group

You can register destinations to a group.

When registering new destinations, you can also register groups at the same time.

- 1** Press the [User Tools/Counter] key.
- 2** Press [System Settings].
- 3** Press [Key Operator Tools], and then press [▼Next].
- 4** Press [Address Book Management].
- 5** Select the user (destination) to register in a group.

Press the user (destination) key, or enter the registered number using the number keys.

 **Note**

r If you press , you can search for a user by user name/index, user code, fax destination, or e-mail address.

- 6** Press [Group].
- 7** Select a group to which you want to register the destinations.



 **Note**

r If you press , you can search for the group by entering the group name.

- 8** Press [OK].

Removing a Destination from a Group

- 1** Press the [User Tools/Counter] key.
- 2** Press [System Settings].
- 3** Press [Key Operator Tools], and then press [▼Next].
- 4** Press [Address Book Management].
- 5** Select the user (destination) to remove from a group.
Press the user (destination) key, or enter the registered number using the number keys.
- 6** Press [Group].
- 7** Press the highlighted group key.



- 8** Press [OK].

Displaying Destinations Registered in Groups

You can check the user (destination) of each group.

- 1** Press the [User Tools/Counter] key.
- 2** Press [System Settings].
- 3** Press [Key Operator Tools], and then press [▼Next].
- 4** Press [Address Book: Program/Change/Delete Group].

5 Select the group where the data you want to check is registered.

6 Press [Programed Users].

All the user (destination) names appear.



Press [OK].

Changing a Group Name

1 Press the [User Tools/Counter] key.

2 Press [System Settings].

3 Press [Key Operator Tools], and then press [▼Next].

4 Press [Address Book: Program/Change/Delete Group].

5 Press the group key you want to change.

6 Enter the items.

To change the group name and key display

A Press [Change] under Group Name or Key Display.

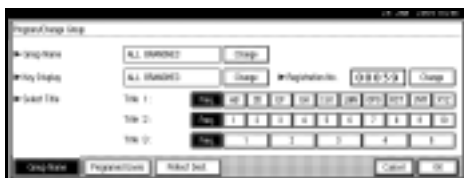

B Enter the new group name or key display, and then press [OK].

To change the title

A Press the title key under Select Title.

To change the registration number

A Press [Change] under Registration No..

B Enter the new registration number using the number keys.

C Press [#].

7 Press [OK].

Deleting a Group

1 Press the [User Tools/Counter] key.

2 Press [System Settings].

3 Press [Key Operator Tools], and then press [▼Next].

4 Press [Address Book: Program/Change/Delete Group].

5 Press [Delete].

6 Press a group key you want to delete.

7 Press [Yes].

Registering the Transfer Request

This section describes how to register the Transfer Station and Receiving Station used in the fax function's Transfer Request.

Note

Before you can use Transfer Request, you must program the Polling ID and set the Transfer Report. See “Programming a Polling ID” and “Transfer Report”, *Facsimile Reference <Advanced Features>*.

Transfer Station

This is the machine that receives the Transfer Request to forward incoming messages to another destination.

Receiving Station

The facsimile or computer that receives messages from the Transfer Station.

Limitation

- r When messages are transferred by fax, Transfer Stations must be machines of the same make as this, and have the Transfer Station function.
- r When messages are transferred by e-mail, Transfer Stations must be machines of the same make as this, and have both the Transfer Station and Internet Fax functions.
- r You cannot use Transfer Request without programming the fax number or e-mail address of the Requesting Party in the Address Book (Quick Dial or Speed Dial) of the Transfer Stations.

Note

- r Polling ID's of the Requesting Party (this machine) and Transfer Stations must be identical.

- r You can have up to 30 Receiving Stations per Transfer Station. If you specify a Transfer Station Group, the Group counts as a single receiver.

Registering a Transfer Station/Receiving Station

- 1** Press the [User Tools/Counter] key.



- 2** Press [System Settings].

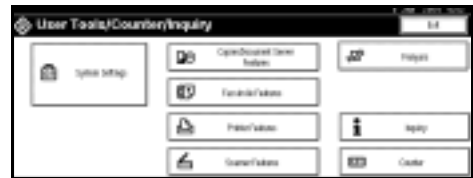

- 3** Press [Key Operator Tools], and then press [▼Next].

- 4** Press [Address Book: Program/Change/Delete Transfer Request].

- 5** Press [New Program].

- 6** Set the Transfer Request's information.

To register the Transfer Request name and key display

A Press [Change] under Transfer Request Name or Key Display.

The user (destination) name or key display entry display appears.

- B** Enter the Transfer Request name or key display, and then press [OK].

 **Reference**
p.147 “Entering Text”

To select the title

- A** To associate a Transfer Request name with a title, press the title key under Select Title.



 **Note**

- r The keys you can select are as follows:
 - [Freq.]... Added to the page that is displayed first.
 - [AB], [CD], [EF], [GH], [IJK], [LMN], [OPQ], [RST], [UVW], [XYZ], [1] to [10]... Added to the list of items in the selected title.
- r You can select [Freq.], and one more page for each title.

- 7** Press [Fax].
- 8** Enter the items. See steps **3** and **9** on p.77 “Registering a Fax Destination”.
- 9** Press [E-mail].
- 10** Enter the items. See steps **3** and **9** on p.82 “Registering an E-mail Destination”.
- 11** Press [Receiving Station].

12 Specify the Receiving Stations.

 **Note**

- r When specifying the Receiving Stations, use the numbers stored in Quick Dial keys, Speed Dials or Groups in the Transfer Station.

Quick Dial

- A** Press [#Quick Dial].
- B** Enter the number stored in the Quick Dial of the Transfer Station using the number keys.
- For example, to select the destination stored in Quick Dial 01 of the Transfer Station, enter [0][1].
- C** To specify an additional Receiving Station, press [Add].

Speed Dial

- A** Press [#*Speed Dial].
- B** Enter the Speed Dial using the number keys.
- For example, to select the destination stored in Speed Dial 12 of the Transfer Station, enter [1][2].
- C** To specify an additional Receiving Station, press [Add].

Group Dial

- A** Press [#*Group Dial].
- B** Enter the Group number using the number keys.
- For example, to select the destinations stored in Group 04 of the Transfer Station, enter [0][4].
- C** To specify an additional Receiving Station, press [Add].

13 When you have specified all the Receiving Stations, press [OK].

14 Press [Exit].

Changing a Registered Transfer Station/Receiving Station

1 Press the [User Tools/Counter] key.

2 Press [System Settings].

3 Press [Key Operator Tools], and then press [▼Next].

4 Press [Address Book: Program/Change/Delete Transfer Request].

5 Select the registered Transfer Station/Receiving Station user you want to change.

Press the user (destination) key, or enter the registered number using the number keys.

 **Note**

r If you press , you can search for a user by Transfer Request name, fax destination, or e-mail address.

6 Enter the items.

To change the Transfer Request name and key display

A Press [Change] under Transfer Request Name or Key Display.

B Enter the new Transfer Request name or key display, and then press [OK].

To change the title

A Press the desired title key under Select Title.

To change the Transfer Station

A Press [Fax].

Proceed to step C when messages are transferred by e-mail.

B Change the Transfer Station's information. See steps **7** and **8** on p.79 "Changing a Registered Fax Destination".

C Press [E-mail].

D Change the Transfer Station's information. See steps **7** and **8** on p.84 "Changing a Registered E-mail Destination".

To change the Receiving Station

A Press [Receiving Station].

B Select the Receiving Station you want to change.

C Press [Clear] to clear the number, and then enter the new number using the number keys.

7 Press [OK].

8 Press [Exit].

Deleting a Registered Transfer Station/Receiving Station

- 1** Press the [User Tools/Counter] key.
- 2** Press [System Settings].
- 3** Press [Key Operator Tools], and then press [▼Next].
- 4** Press [Address Book: Program/Change/Delete Transfer Request].
- 5** Press [Delete].
- 6** Select a Transfer Request you want to delete.
Press the Transfer Request key, or enter the registered number using the number keys.
- 7** Press [Yes].
- 8** Press [Exit].

Programming/Changing LDAP Server

Programming an LDAP server allows you to look up e-mail destinations from the LDAP server Address Book directly. This function is available when you send scan files by e-mail using scanner function.

Note

- r Select **[ON]** in the Use LDAP Server setting to use this function. See p.66 “Use LDAP Server”.
- r This function supports LDAP Version 2 and 3.
- r To ensure successful searching, make sure the server name and port number are entered correctly. For details, ask your network administrator.

Programming an LDAP Server

1 Press the **[User Tools/Counter]** key.



2 Press **[System Settings]**.



3 Press **[Key Operator Tools]**, and then press **[▼Next]** twice.

4 Press **[Program/Change LDAP Server]**.

5 Enter the items.

To enter an identification name

A Press **[Change]** under **Identification Name**.



B Enter the server's identification name.

C Press **[OK]**.

To enter a server name

A Press **[Change]** under **Server Name**.

B Enter the LDAP server name.

C Press **[OK]**.

To enter the search base

A Press **[Change]** under **Search Base**.

B Enter the search base.

Note

- r For example, if you enter “ou=sales department, o=ABC”, searching will start below the sales department level of ABC company (here, “ou” stands for organization unit, and “o” stands for company).

C Press **[OK]**.

To enter a port number

- A Press [Change] under Port No..
 - B Enter the port number using the number keys, and then press [#].
-

To set authentication

- A Press [Next].
- B Press [ON] or [High Security] under Authentication.



Note

- r [High Security] is not available with LDAP Version 2.
 - r When [ON] or [High Security] is selected, the administrator account name and password is required to access the LDAP server.
 - r When [High Security] is selected, you can use a generic password unique to the network. If you do this, the server also requires the same setting. For details, ask your network administrator.
-

To enter the user name and password

Note

- r To use the administrator account for authentication, enter the account name and password here.

- r If you leave the user name and password blank, users will be prompted for the password every time they attempt to connect to the LDAP server.

- A Press [Next].
 - B Press [Change] under User Name.
 - C Enter the user name, and then press [OK].
 - D Press [Change] under Password.
 - E Enter the password, and then press [OK].
-

To test the connection

- A Press [Connection Test].

A connection test is carried out.

- B Press [Exit].

Note

- r If the connection test fails, check your settings, and then try again.
-

To set search options

Note

- r You can search the LDAP server data using keywords below: Name, E-mail Address, Fax Destination, Company Name, Department Name. You can specify an additional keyword. This must be predefined in your LDAP database.

- A Press [Next] twice.
- B Press [Change] under Attribute.
- C Enter the attribute you want to use for searching e-mail addresses, and then press [OK].
- D Press [Change] under Key Display.

E Enter the attribute's display name, and then press [OK].

Note

- r For example, if you want to sort e-mail addresses by employees' number, enter "employeeNo" in the Attribute field, and "Employee No." in the Key Display field.

6 Press [OK].

7 Press [Exit].

8 Press the [User Tools/Counter] key.

4

Changing an LDAP Server

1 Press the [User Tools/Counter] key.

2 Press [System Settings].

3 Press [Key Operator Tools], and then press [▼Next] twice.

4 Press [Program/Change LDAP Server].

5 Change the items.

To change an identification name

A Press [Change] under Identification Name.



B Enter a new identification name for the server.

C Press [OK].

To change the server name

A Press [Change] under Server Name.

B Enter the new LDAP server name.

C Press [OK].

To change the search base

A Press [Change] under Search Base.

B Enter the new search base.

C Press [OK].

To change a port number

A Press [Change] under Port No..

B Enter the new port number using the number keys, and then press [#].

To change authentication

A Press [Next].

B Select [ON] or [High Security] if you want to activate authentication. Select [OFF] to cancel it.

Note

- r [High Security] is not available when the LDAP Version is 2.
- r When [ON] or [High Security] is selected, the administrator account name and password is required to access the LDAP server.
- r When [High Security] is selected, you can use a generic password unique to the network. If you do this, the server also requires the same setting. For details, ask your network administrator.

To change the user name and password

- A Press [Next].
- B Press [Change] under User Name.
- C Enter the new user name, and then press [OK].
- D Press [Change] under Password.
- E Enter the new password, and then press [OK].

 **Note**

- r The user name and password are of a user who is authorized to access the LDAP server.
- r You can press [Connection Test] to check if the new settings work.

To change search options

- A Press [Next] twice.
 - B Press [Change] under Attribute.
 - C Enter a new attribute, and then press [OK].
 - D Press [Change] under Key Display.
 - E Enter the attribute's new display name, and then press [OK].
- 6** Press [OK].
 - 7** Press [Exit].
 - 8** Press the [User Tools/Counter] key.

5. Troubleshooting

If Your Machine Does Not Operate As You Want

The following chart gives explanations of common problems and messages. If other messages appear, follow the instructions displayed.

Note

- r If you cannot make copies as you want because of paper type, paper size or paper capacity problems, use recommended paper. See p.167 “Copy Paper”.

General

Problem	Causes	Solutions
“Please wait.” appears	This message appears when you turn on the operation switch or change the toner bottle.	Wait for the machine to get ready.
The display is off.	The screen contrast knob is turned to the dark position.	Set the screen contrast knob to the light position to see the display panel properly.
	The machine is in Energy Saver mode.	Press the [Energy Saver] key to cancel Energy Saver mode.
	The operation switch is turned off.	Turn on the operation switch.
Nothing happens when the operation switch is turned on.	The main power switch is turned off.	Turn on the main power switch.
Memory is full.	There are too many scanned pages or stored files: hard disk capacity is exceeded.	Press [Delete File] to delete unnecessary documents.
The function status indicator is red.	The function associated with the red indicator was interrupted.	Press the function key corresponding to the indicator. Follow the instructions that appeared on the control panel.
The user code entry display appears.	Users are restricted by user management.	Enter the user code (up to eight digits), and then press [#] .

Problem	Causes	Solutions
The main power indicator continues blinking and does not turn off when pressed.	This occurs in the following cases: <ul style="list-style-type: none"> • The exposure glass cover or the ADF is open. • The machine is communicating with external equipment. • The hard disk is active. 	Close the exposure glass cover or ADF, and check if the machine is communicating with a computer.
Original images are printed on the reverse side of the paper.	You may have loaded the paper incorrectly.	Load paper correctly. Load paper into Tray 1-4 with the print side up, and into the LCT or bypass tray with the print side down. See p.112 "Orientation-Fixed Paper or Two-Sided Paper".
Misfeeds occur frequently.	The tray's side guides may not be locked.	Check the side guides are locked. p.126 "Changing the Paper Size".
	The tray's end guide may not be set properly.	Check the end guide is set properly. See p.126 "Changing the Paper Size".
	You may have loaded paper of a size not shown on the paper size selector.	When using paper of a size that cannot be detected automatically, use Tray Paper Settings to set the paper size. See p.55 "Tray Paper Size: Tray 1-4" and p.167 "Copy Paper".
An error message remains, even if misfed paper is removed.	When a misfeed message appears, it remains until you open and close the cover, as required.	Clear misfed paper, and then open and close the front cover. See p.116 "Clearing Misfeeds".
Cannot print in duplex mode.	You cannot use paper in the bypass tray for duplex printing.	For duplex printing, select Tray 1-4 in copier mode or with the printer driver.
	[1 Sided Copy] is selected for Paper Type: Tray 1-4.	Select [2 Sided Copy] for Paper Type: Tray 1-4. See p.56 "Paper Type: Tray 1-4"
You forgot your key operator code	—	Contact your service representative.

Document Server

Problem	Solutions
"Scanned pages exceeded max. number. Do you want to store the scanned pages as a file?" appears.	<p>The number of scanned pages exceeds the capacity per file of the Document Server.</p> <p>To store scanned pages as a file, press [Store File]. Scanned data is stored as a file in the Document Server. If you do not want to store scanned pages, press [No]. Scanned data is deleted.</p>
You forgot your password.	<p>You can temporarily access password-protected files temporarily.</p> <p>Press [Unlock] in Password Management for Stored Files in User Tools. See p.151 "Temporarily Disabling Document Security" .</p> <p>You can delete all stored documents at once with User Tools. See p.65 "Delete All Files" .</p> <p>Make sure no important documents are stored in the Document Server before deleting all stored documents.</p>
You cannot find out what is stored in a file.	Check the date or time column in the Document Server: Select Files to Print display.
	Check the document content by printing its first page. Press the line of the desired document in the Document Server: Select Files to Print display, and then press [Print 1st Page] followed by the [Start] key.
Memory frequently becomes full.	<ul style="list-style-type: none"> • Press [Delete File] to delete selected documents, to increase available memory. • Delete documents stored using the scanner function. See <i>Scanner Reference</i>.
You want to check print quality before making a large print run.	Check print quality by printing out only the first set using the [Sample Copy] key.
"Original is being scanned by another function." appears.	The copier or scanner function is in use. To cancel a job in progress, first press [Exit] , and then press the [Copy] key or [Scanner] key. Next, press the [Clear/Stop] key. When the message "[Stop] key was pressed. Stop printing?" appears, press [Stop] .

⏴ Loading Paper

🔍 Reference

For paper types and sizes, see p.167 “Copy Paper”.

Loading Paper into Paper Trays

📌 Note

☞ You can change the paper size, see p.126 “Changing the Paper Size”.

1 Pull the paper tray out slowly until it stops.

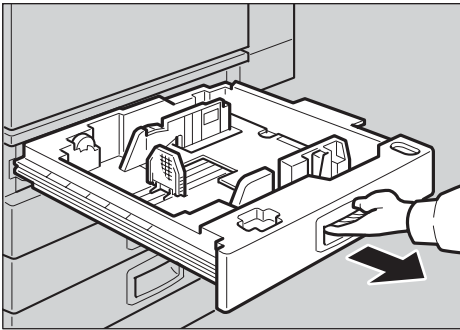

2 Square the paper, and then load it into the tray.

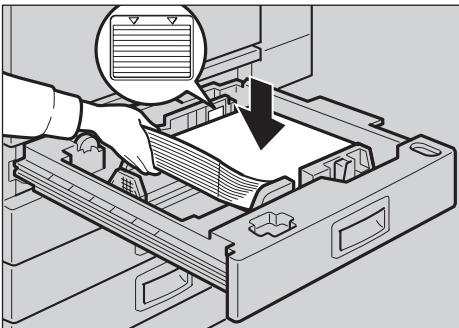

⚠ Important

☞ Check that the top of the stack is not higher than the limit mark inside the tray.

☞ Make sure the paper stack is flush against the right side fence.

📌 Note

☞ Fan the paper before loading.
☞ Straighten curled or warped paper before loading.

3 Push the paper tray in until it stops.

Loading Paper into Large Capacity Tray (optional)

1 Press the key if it is not lit.

The key blinks while the bottom plate is moving down.

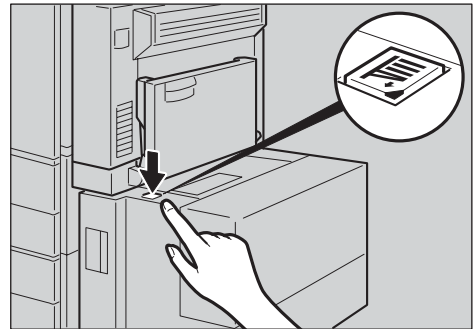

2 When the key stops blinking and lights up, open the top cover.

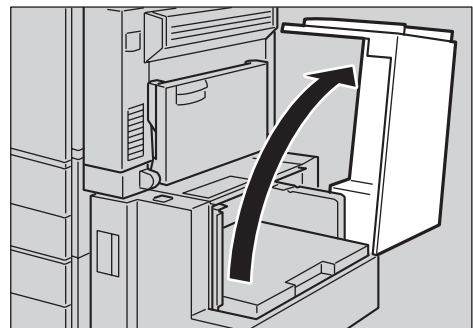

 **Note**

- r Make sure no paper sheet is involved in the paper feeding side of the LCT. Remove the sheet, if any.

3 Load paper into the tray along the edge on the left.

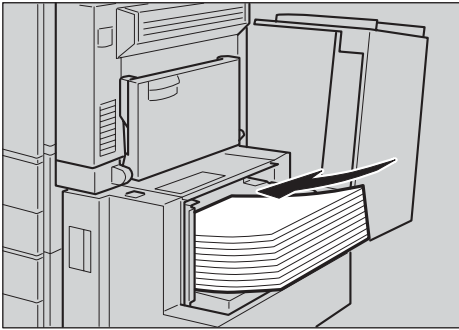

 **Note**

- r The tray contains up to 1,500 sheets.







 **Important**

- r Make sure the paper stack is flush against the left side fence.
- r Check the top of the stack is not higher than the limit mark inside the tray.

4 Close the top cover.

Orientation-Fixed Paper or Two-Sided Paper

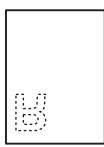
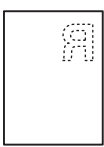
Orientation-fixed (top to bottom) or two-sided paper (for example, letterhead paper, prepunched paper, or copied paper) might not print correctly, depending on how the originals and paper are placed. Select **[Yes]** in Letterhead Setting under Copier/Document Server Features, and then place the original and paper as shown below (see *Copy Reference*). When printing with the printer function, placing orientation is the same.

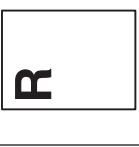
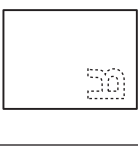
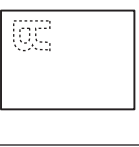
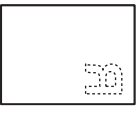
Copy Mode		Paper Tray	Large Capacity Tray	Bypass Tray	
				When originals are placed on the exposure glass	When originals are placed on the ADF
Exposure Glass 	1 Sided			 *1	 *1
	2 Sided			—	—
Exposure Glass 	1 Sided		—	 *1	 *1
	2 Sided		—	—	—

*1 When the paper size is specified.

 : Shows the paper frontside facing up.

 : Shows the paper backside facing up.

Adding Toner

When  appears, it is time to add toner.

WARNING:

- ***Do not incinerate used toner or toner containers. Toner dust might ignite when exposed to an open flame. Dispose of used toner containers in accordance with local regulations.***

CAUTION:

- *Keep toner (used or unused) and toner containers out of reach of children.*

Important

- r Faults may occur if you use toner other than the recommended type.
- r When adding toner, do not turn off the operation switch. If you do, settings will be lost.
- r Always add toner when the machine instructs you.
- r Do not repeatedly install and remove toner bottles. This will result in toner leakage.
- r Do not shake the removed toner bottle. Remaining toner might scatter.

Note

- r You can make about 90 copies even after the “ Toner is almost empty.” and “Replace Toner Bottle.” messages appear, but replace toner early to prevent poor copy quality.

Reference

For details about toner storage, see p.140 “Toner Storage”.

Removing Toner

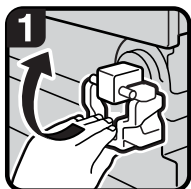

- 1: Open the front cover of the machine.
- 2: Lift the green lever.

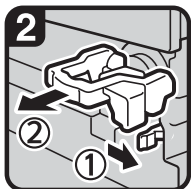

- 3: Push the green lever, and then gently pull out the holder.



- 4: Press the toner bottle back to raise its top, and then gently pull it out.

5

Inserting Toner



- 1: Hold the new bottle horizontally and shake it from side to side five or six times.

 **Note**

- r Do not remove the black cap before shaking.



- 2: Remove the black cap.

 **Note**

- r Do not remove the inner cap.



- 3: Put the toner bottle on the holder, and then pull its top forward.

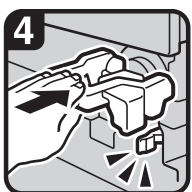

- 4: Push in the green lever until it clicks.



- 5: Press down the green lever.
- 6: Close the machine's front cover.

Clearing Misfeeds

CAUTION:

- *The fusing section of this machine might be very hot. Caution should be taken when removing misfed paper.*

Important

- r When clearing misfeeds, do not turn off the operation switch. If you do, your copy settings will be lost.
- r To prevent misfeeds, do not leave any torn scraps of paper inside the machine.
- r If paper misfeeds occur frequently, contact your service representative.

Note

- r More than one misfeed may be indicated. When this happens, check all the areas indicated. See the following charts: A, B, C, D, E, P, U, R, Y, Z
- r Inside the finisher, or inside the front cover, there is a sticker explaining how to remove misfed paper.

■ When E is lit

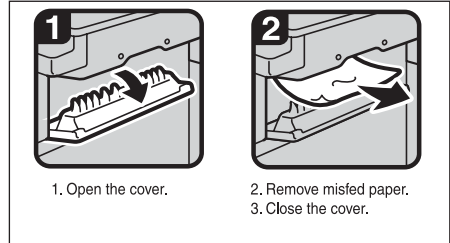

■ When D is lit

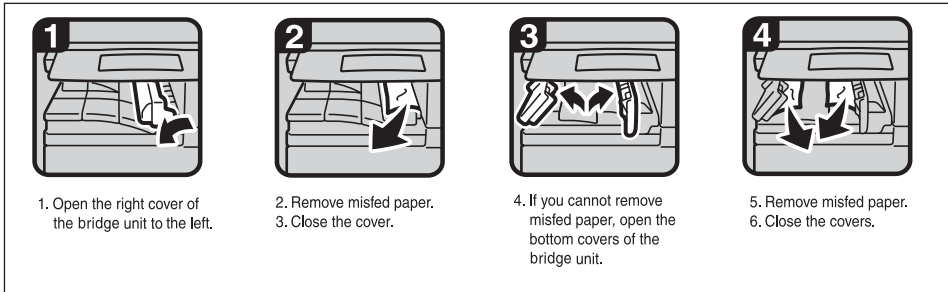

■ When B is lit

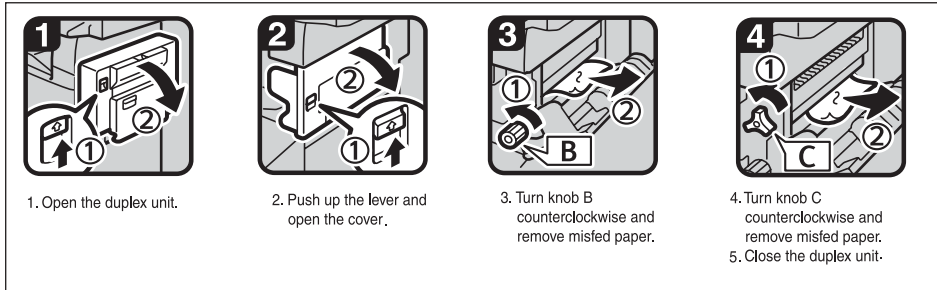

■ When A is lit

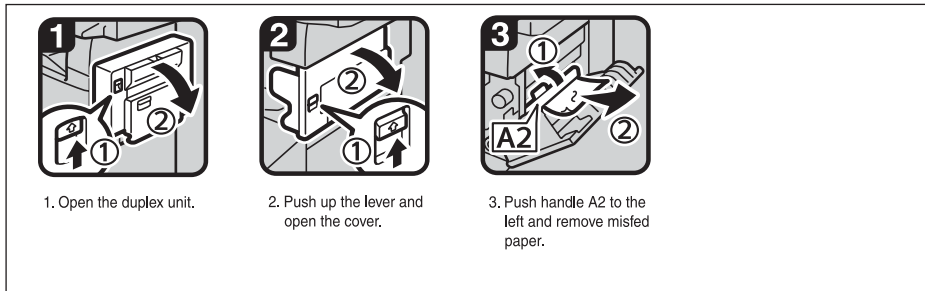

■ When C is lit

1. Open the duplex unit.
2. Open the front cover.
3. Push up the lever and open the cover.
4. Turn knob C clockwise or counterclockwise and remove misfed paper.
5. If you cannot remove misfed paper from the machine's side, remove it from the right side.
6. When paper is jammed in knob C, turn knob C clockwise to remove misfed paper.

7. If you cannot remove misfed paper, turn knob C counterclockwise to remove misfed paper.

8. Close the cover.
9. Close the duplex unit and front cover.

If you still cannot remove misfed paper
Contact your service representative.

5

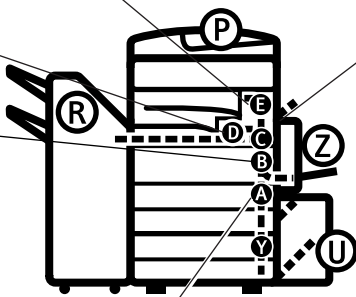

4. If you cannot remove misfed paper, open the cover.
If your machine is equipped with the large capacity tray, slide it to the right.
5. Turn knob A1 downward.
6. Push handle A2 to the left and remove misfed paper.
7. Open the bypass tray and remove misfed paper.

You can make an enlarged copy of this page and stick it on wall.

■ When R is lit

1000-Sheet finisher

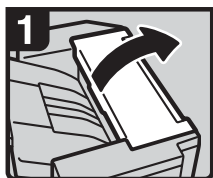

1. Open the upper cover.



2. Remove misfed paper.

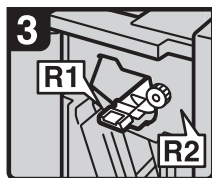

3. Open the front cover.

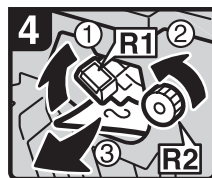

4. Hold up lever R1 and turn knob R2 to remove misfed paper.

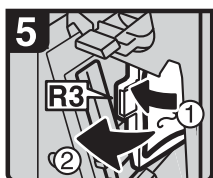

5. If you cannot remove misfed paper, open lever R3 to the left and remove misfed paper.

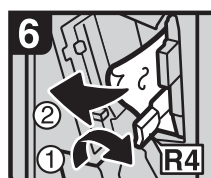

6. Hold down lever R4 and remove misfed paper.

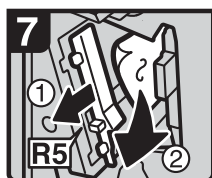

7. Pull lever R5 and remove misfed paper.
8. Close the front cover.

5

2 Tray finisher

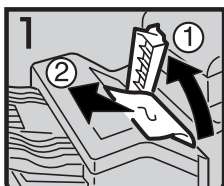

1. Open the upper cover.
2. Remove misfed paper.

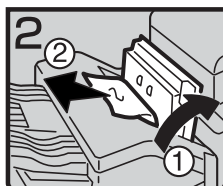

3. If you cannot remove misfed paper, open the side cover and remove misfed paper.

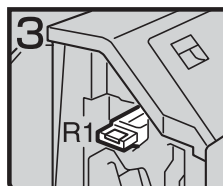

4. Open the front cover.

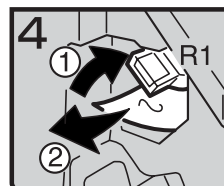

5. Hold up lever R1 and remove misfed paper.

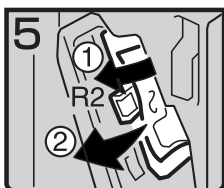

6. Hold down lever R2 and remove misfed paper.

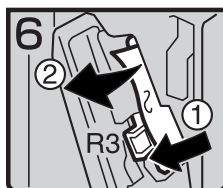

7. If you cannot remove misfed paper, hold down lever R3 and remove misfed paper.

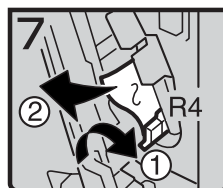

8. Hold down lever R4 and remove misfed paper.

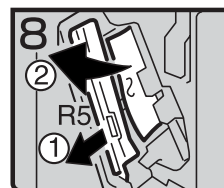

9. Pull lever R5 and remove misfed paper.
10. Close the front cover.

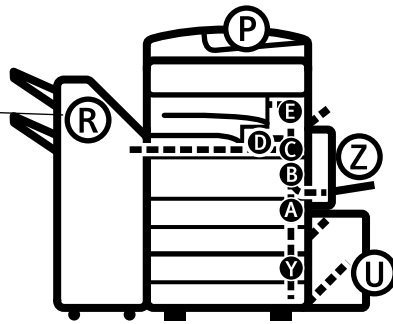

You can make an enlarged copy of this page and stick it on wall.

■ When R is lit

Booklet finisher

If R1 or R2 is lit

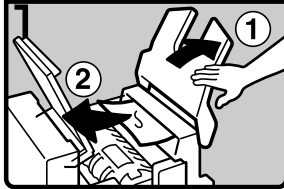

1. Lift the finisher upper tray, and then open the upper cover.
2. Remove misfed paper.

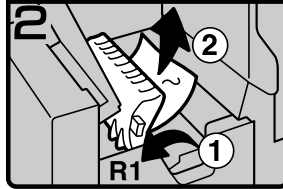

3. If you cannot remove misfed paper, hold up lever R1 and remove misfed paper.

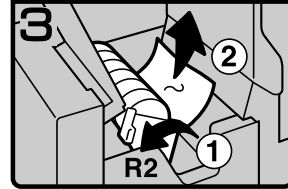

4. Hold up lever R2 and remove misfed paper.
5. Lower the finisher proof tray, and then close the upper cover.

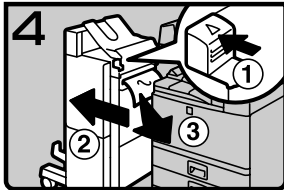

6. While pushing the release lever, remove the finisher.
7. Remove misfed paper.
8. Return the release lever until it clicks, and then attach the finisher.

If R3, R4 or R5 is lit

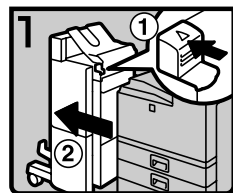

1. While pushing the release lever, remove the finisher.

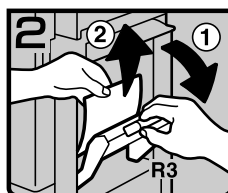

2. Hold up lever R3 and remove misfed paper.

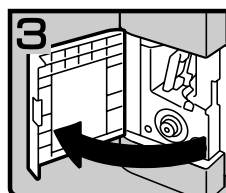

3. If you cannot remove misfed paper, open the lower front cover.

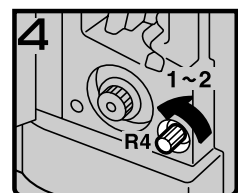

4. Turn knob R4 counterclockwise.
- Note
- Depending on the location of misfed paper, knob R4 might not turn.

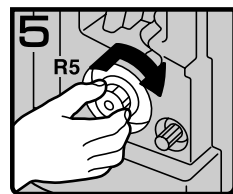

5. While pushing knob R5, turn it clockwise.

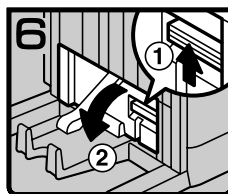

6. Hold up the lever on the upper right of the booklet tray, and open the cover.

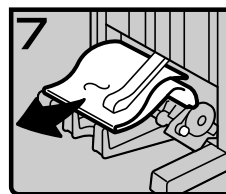

7. Remove misfed paper.
8. Close the cover.

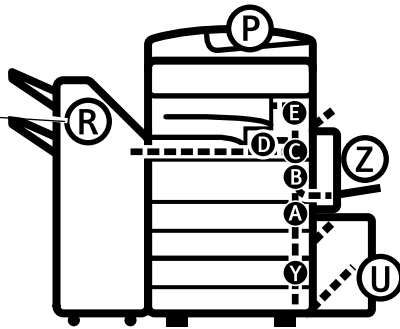

You can make an enlarged copy of this page and stick it on wall.

■ When P is Lit

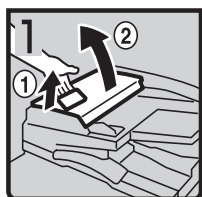

1. Lift the lever ① and open the upper cover ②.

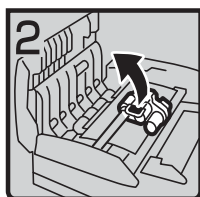

2. Lift the lever.

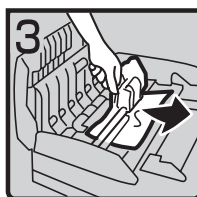

3. Remove misfed original.



4. If you cannot remove the misfed original, turn the dial ① clockwise and remove the misfed original ②.



5. Open the cover.

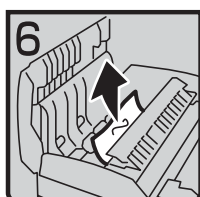

6. Remove the misfed original and close the cover.

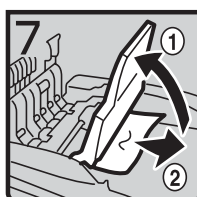

7. If you cannot remove the misfed original, hold up the tray and remove the original.

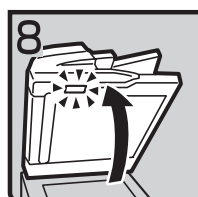

8. Close the upper cover.
9. Lift the document feeder and check the sticker.

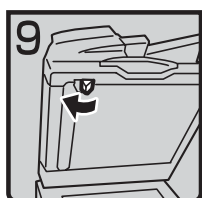

10. Slide blue lever to the left.

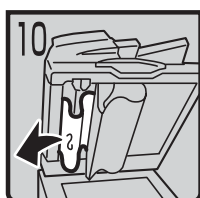

11. Pull the cover and remove the misfed original.

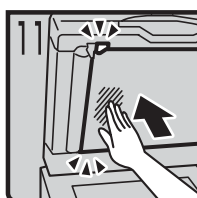

12. Push center of the cover and close until it clicks.

5

■ When Y is Lit

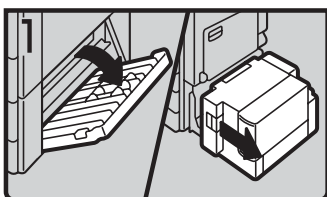

1. Open the right cover of the paper tray unit. If your machine is equipped with the large capacity tray, slide it to the right and open the right cover of the paper tray unit.

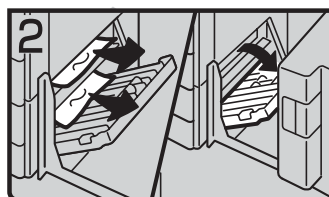

2. Remove misfed paper.

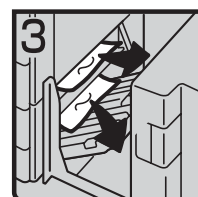

3. Close the right cover of the paper tray unit. If your machine is equipped with the large capacity tray, set it back.

■ When Z is Lit

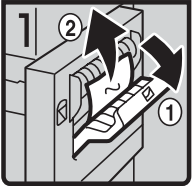

1. Open the side cover of duplex unit and remove misfed paper.

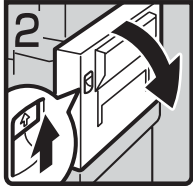

2. If you cannot remove misfed paper, open the duplex unit.

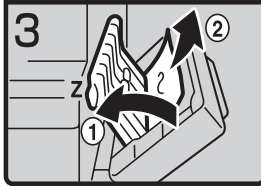

3. If you cannot find misfed paper, open cover Z and remove misfed paper.
4. Close the duplex unit.

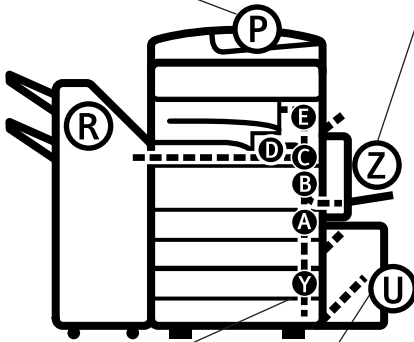

5

■ When U is Lit

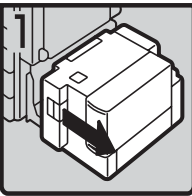

1. Slide the large capacity tray to the right.

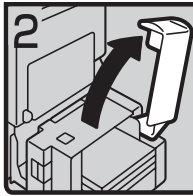

2. Open the top cover of the large capacity tray.

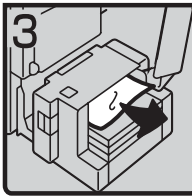

3. Remove misfed paper.

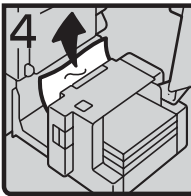

4. If you cannot remove the misfed paper, try to remove the misfed paper from the left side of the large capacity tray.
5. Close the top cover and return the Large Capacity Tray(LCT).

You can make an enlarged copy of this page and stick it on wall.

Changing the Paper Size

Preparation

Be sure to select the paper size with User Tools and the paper size selector. If you do not, misfeeds might occur. See p.55 “Tray Paper Size: Tray 1-4”.

Important

If you want to change the paper size set in the LCT, contact your service representative.

Reference

For details about paper sizes and types, see p.167 “Copy Paper”.

5

Changing the Paper Size of the Paper Tray

1 Make sure the paper tray is not in use. Then, pull the paper tray out slowly.

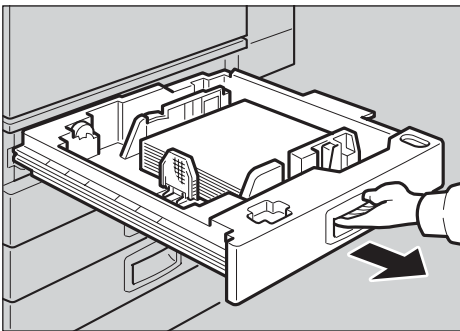

2 If paper is loaded in the tray, remove it.

3 Release the side lever to the "unlocked" position.

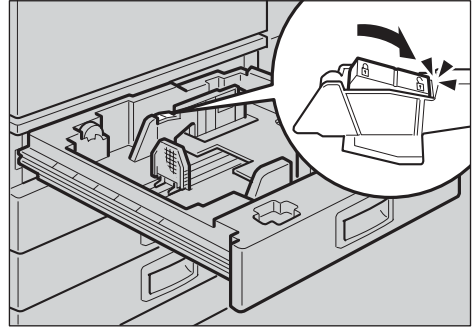

4 While pressing the release lever, adjust the side fences.

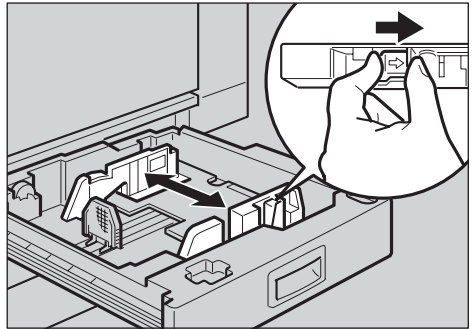

5 Adjust the back guide to the new paper size.

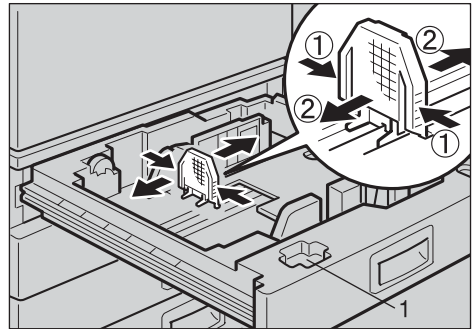

Note

If you are using 11" × 17" paper, put the back guide inside 1.

- 6** Square the paper and load it into the tray.

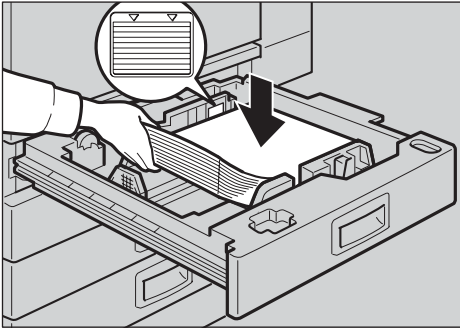

Important

- r Check that the top of the stack is not higher than the limit mark inside the tray.
- r Make sure the paper stack is flush against the right side fence.

Note

- r Fan the paper before loading.
- r Straighten curled or warped paper before loading.

- 7** After loading, make sure that on either side, the paper does not catch (on 1). Push down the paper stack.

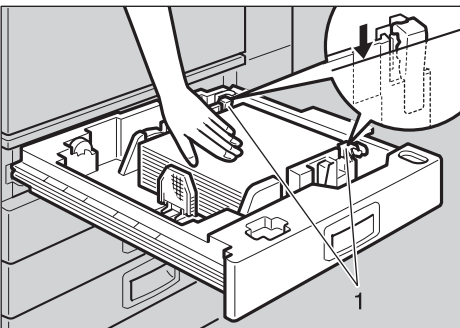

- 8** Lock the side lever.

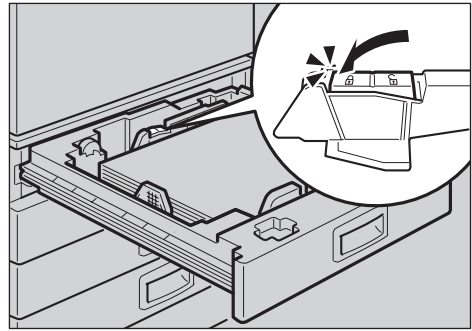

- 9** Adjust the tray size with the paper size selector to the new paper size.

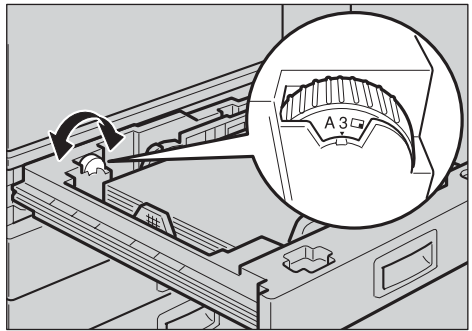

To adjust the paper size to a size not indicated on the paper size selector

- A Set the paper size selector to the ✖ mark.
- B Press the [User Tools/Counter] key.
- C Press [System Settings].
- D Press [Tray Paper Settings].
- E Press [Tray Paper Size: Tray 1], [Tray Paper Size: Tray 2], [Tray Paper Size: Tray 3] or [Tray Paper Size: Tray 4].
- F Select the required size, and then press [OK].

Ⓒ **Press [Exit] or the [User Tools/Counter] key to quit User Tools.**

 **Reference**

p.55 “Tray Paper Size: Tray 1-4”

10 Gently push the paper tray in until it stops.

11 Check the paper size shown on the display panel.

Adding Staples

Important

Stapling failure or jams may occur if you use a staple cartridge other than that recommended.

Reference

For details about the type of finisher, see p.18 “External Options”.

1000-Sheet Finisher

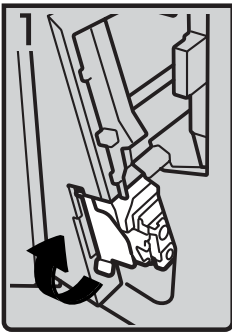

- 1: Open the front cover of the finisher, and then pull out the staple unit.

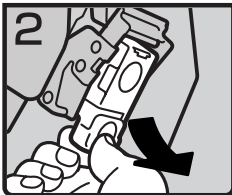

- 2: Hold the green lever while gently pulling out the cartridge.

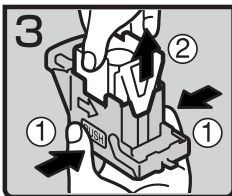

- 3: Hold both sides of the cartridge.
- 4: Pull up the upper unit of the cartridge.

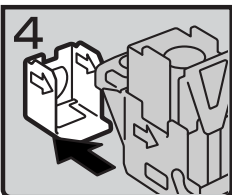

- 5: Take out the empty refill in the arrow direction.

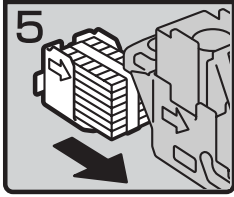

- 6: Align the arrows on the new refill with those on the cartridge, and then push in the refill until it clicks.

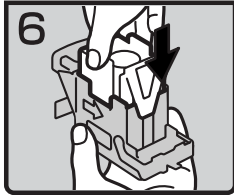

- 7: Gently push down the upper unit into the cartridge.

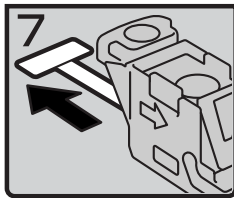

- 8: Pull out the ribbon.

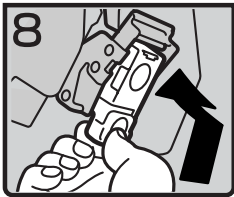

- 9: Hold the green lever while pushing in the cartridge until it clicks.
- 10: Push back the staple unit, and then close the front cover of the finisher.

5

2 Tray Finisher

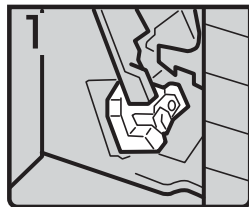

- 1: Open the front cover of the finisher.

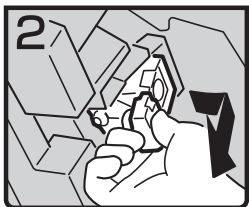

- 2: Hold the green lever while gently pulling out the cartridge.

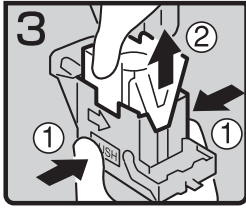

- 3: Hold both sides of the cartridge.
- 4: Pull up the upper unit of the cartridge.

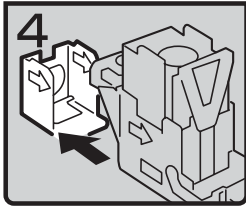

- 5: Take out the empty refill in the arrow direction.

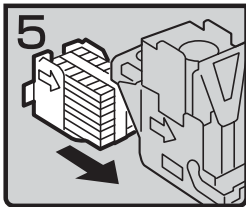

- 6: Align the arrows on the new refill and the cartridge, and then push in the refill until it clicks.

5

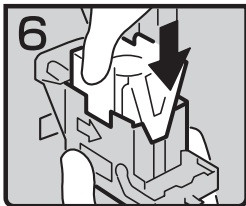

- 7: Gently push down the upper unit into the cartridge.

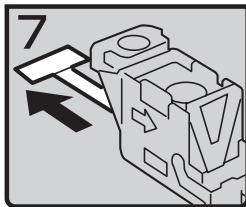

- 8: Pull out the ribbon.

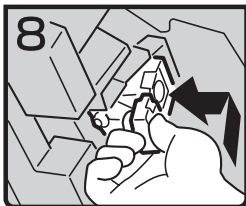

- 9: Hold the green lever while pushing in the cartridge until it clicks.
- 10: Close the front cover of the finisher.

Booklet Finisher

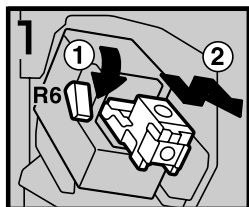

- 1: Open the front cover of the finisher.
- 2: Pull lever R6 down, and then pull out the cartridge while lifting the cartridge.

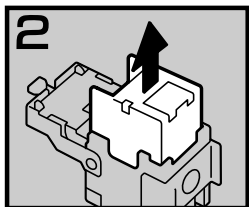

- 3: Take out the empty refill in the arrow direction.

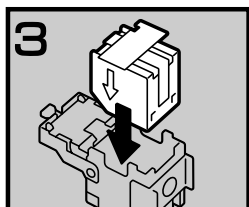

- 4: Set the new refill.

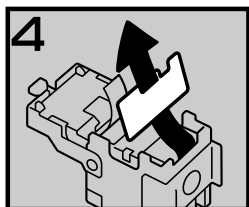

- 5: Pull out the ribbon.

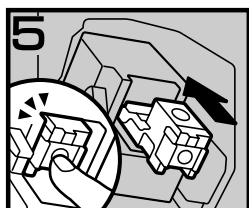

- 6: Push in the cartridge until it clicks.
- 7: Close the front cover of the finisher.

Staple unit for saddle stitch function

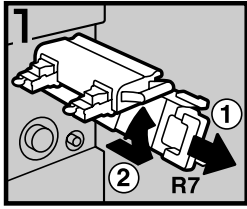

- 1: Open the front bottom cover of the finisher.
- 2: Pull lever R7 and fully pull out the staple unit.
- 3: Lift the lever of the staple unit while pulling it.

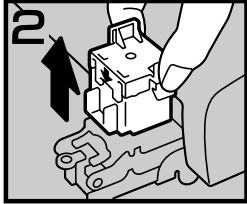

- 4: Take out the empty cartridge.

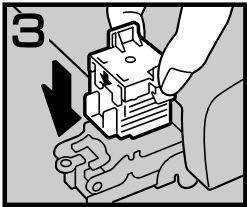

- 5: Set the new cartridge.
- 6: Bring the staple unit back into place.
- 7: Close the front bottom cover of the finisher.

5

v Using “Prepare Stapling” in User Tools to initialize the staple unit

When the booklet finisher is installed, make sure to initialize the staple unit for the saddle stitch function with User Tools after adding staples or removed jammed staples. If you do not do this, copies may not be stapled and misfeeds may occur.

Reference

p.54 “Prepare Stapling”

- ① Press the **[User Tools/Counter]** key.
- ② Press **[System Settings]**.
- ③ Press **[Prepare Stapling]** on the menu of General Features 2/2.
- ④ Press **[OK]**.
The machine staples five to seven times without ejecting staples.
- ⑤ Press **[Exit]**.
- ⑥ Press **[Exit]**.

Removing Jammed Staples

 **Note**

- r Curled paper may cause staples to jam. To avoid this, turn copy paper over in the tray. If there is no improvement, change to stiffer copy paper.
- r When the booklet finisher is installed, after removing jammed staples, staples will not be ejected the first few times you try to use the stapler.

 **Reference**

For types of finisher, see p.18 “External Options”.

1000-Sheet Finisher

5

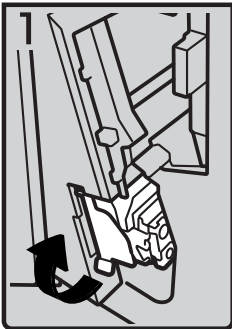

- 1: Open the front cover of the finisher, and then pull out the staple unit.

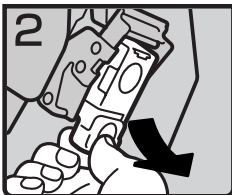

- 2: Hold the green lever while gently pulling out the cartridge .

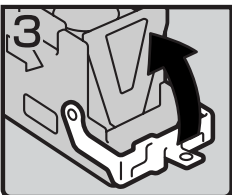

- 3: Open the cartridge's face plate.

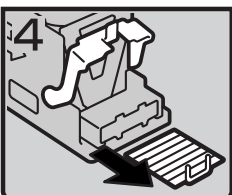

- 4: Remove any jammed staples.

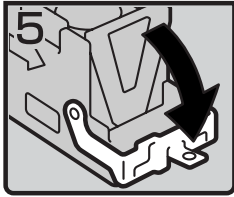

- 5: Pull down the cartridge's face plate until it clicks.

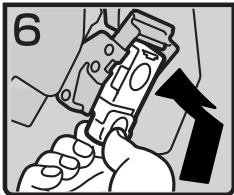

- 6: Hold the green lever while pushing in the cartridge until it clicks.
- 7: Push back the staple unit, and then close the front cover of the finisher.

2 Tray Finisher

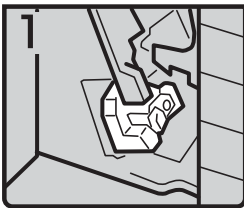

- 1: Open the front cover of the finisher.

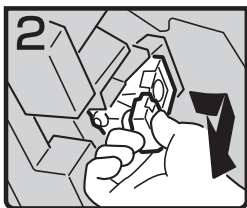

- 2: Hold the green lever while gently pulling out the cartridge .

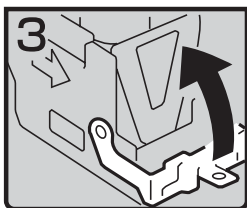

- 3: Pull up the cartridge's knob.

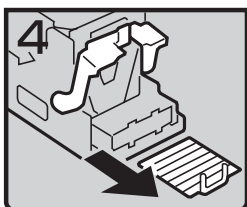

- 4: Take out all staples slid from the cartridge.

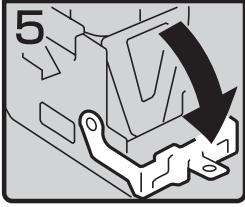

- 5: Pull down the cartridge's knob until it clicks.

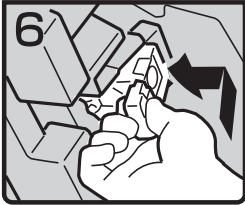

- 6: Hold the green lever while pushing in the cartridge until it clicks.
- 7: Close the front cover of the finisher.

Booklet Finisher

5

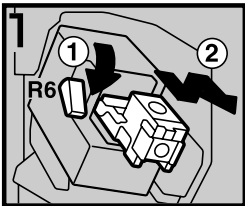

- 1: Open the front cover of the finisher.
- 2: Pull lever R6 down, and then pull out the cartridge while lifting the cartridge.

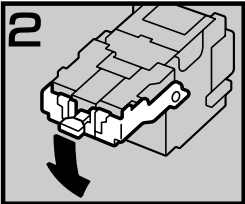

- 3: Pull down the cartridge's knob.

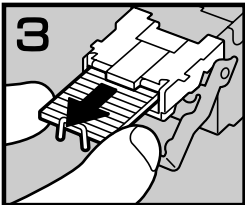

- 4: Take out all staples slid from the cartridge.

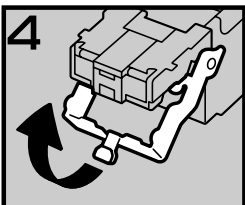

- 5: Set the cartridge's knob back into place.

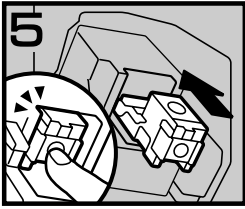

- 6: Push in the cartridge until it clicks.
- 7: Close the front cover of the finisher.

Staple unit for saddle stitch function

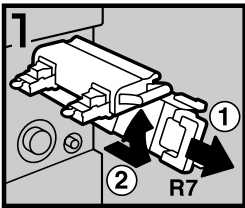

- 1: Open the front bottom cover of the finisher.
- 2: Pull lever R7 and fully pull out the staple unit.
- 3: Lift the lever of the staple unit while pulling it.

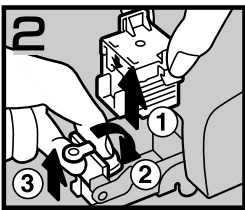

- 4: Take out the cartridge.
- 5: Pull the blue knob down, and then lift the knob of the face plate.

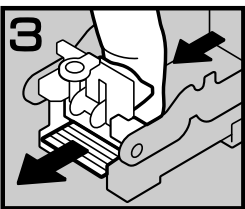

- 6: Remove all jammed staples.

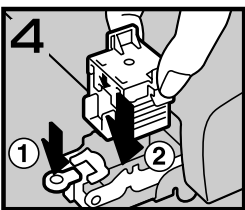

- 7: Bring the face plate back into place by pushing it.
- 8: Push the cartridge.
- 9: Bring the staple unit back into place, and then close the front bottom cover of the finisher.

Reference

Initialize the staple unit for the saddle stitch function after removing jammed staples. See p.133 “Using “Prepare Stapling ”in User Tools to initialize the staple unit”.

Removing Punch Waste

Note

While “Punch Receptacle Full” is displayed, you cannot use the Punch function.

1 Open the front cover of the 2 Tray finisher.

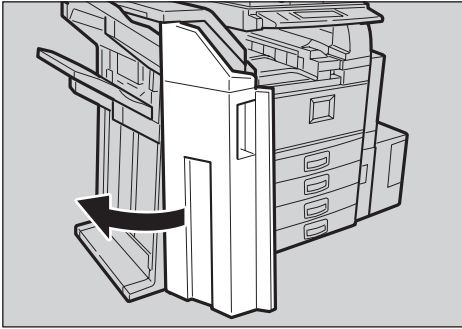

2 Pull out the punch waste box, and then remove punch waste.

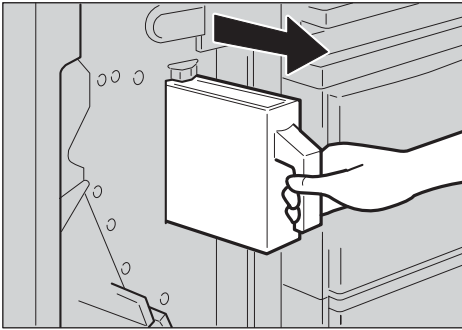

3 Reinstall the punch waste box.

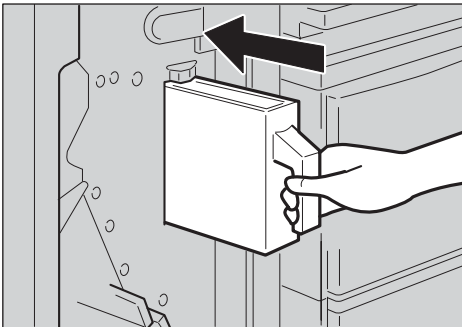

Note

If you do not, “Punch Receptacle Full” is still displayed.

4 Close the front cover of the 2 Tray finisher.

“Punch Receptacle Full” disappears.

Note

If the message is still displayed, reinstall the punch waste box.

The message “Punch Receptacle Full” may appear even when the punch waste box is not yet full. If this happens, the position of the punch waste box (indicated by the arrow as shown) may be blocked by punch waste. Remove the punch waste.

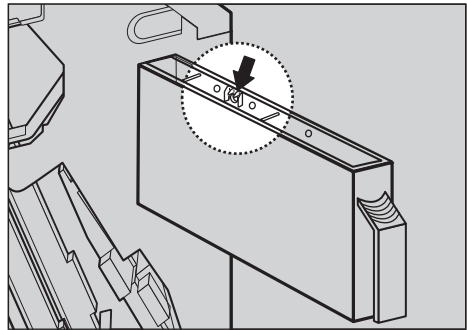

Dos and Don'ts

CAUTION:

- *Unplug the power cord from the wall outlet before you move the machine. While moving the machine, you should take care that the power cord will not be damaged under the machine.*

Important

- r Do not turn the power off while the On indicator is lit or blinking. Doing so may damage the hard disk.
- r Before unplugging the power cord or turning off the main power switch, make sure remaining memory space is at 100%, as shown on the display. See p.24 “Turning Off the Power” and “Turning Off the Main Power”.
- When you use this machine for a long time in a confined space without good ventilation, you may detect an odd smell. To keep the workplace comfortable, we recommend that you keep it well ventilated.
- Do not touch areas on or around the fusing unit. These areas get hot.
- After making copies continuously, the exposure glass may become warm—this is not a malfunction.
- The area around the ventilation hole might feel warm. This is caused by exhaust air and is not a malfunction.
- When the machine is not in use and in stand-by mode, you may hear a small noise inside. This is caused by the image stabilization process and is not a malfunction.
- Do not turn off the operation switch while copying or printing. Make sure all copying or printing has finished first.
- The machine might not produce good copy images if condensation forms inside as a result of rapid temperature change.
- Do not open the covers of the machine while copying or printing. If you do, misfeeds might occur.
- Do not move the machine during copying or printing.
- If you operate the machine improperly or a machine failure occurs, settings might be lost. Be sure to make a note of your machine settings.
- The manufacturer shall not be liable for any loss or damage resulting from mechanical failure, loss of settings, or use of the machine.

Toner

Handling Toner

 **WARNING:**

- *Do not incinerate used toner or toner containers. Toner dust might ignite when exposed to an open flame. Dispose of used toner containers in accordance with local regulations.*

 **CAUTION:**

- *Keep toner (used or unused) and toner containers out of reach of children.*

 **Important**

r Faults may occur if you use toner other than the recommended type.

 **Reference**

To add toner, see p.113 “ Adding Toner”.

6

Toner Storage

When storing toner, the following precautions should always be followed:

- Store toner containers in a cool, dry place free from direct sunlight.
- Store on a flat surface.

Used Toner

 **Note**

r Toner cannot be re-used.

Where to Put Your Machine

Machine Environment

Choose your machine's location carefully. Environmental conditions greatly affect its performance.

Optimum environmental conditions

CAUTION:

- *Keep the machine away from humidity and dust. Otherwise a fire or an electric shock might occur.*
- *Do not place the machine on an unstable or tilted surface. If it topples over, an injury might occur.*

CAUTION:

- *If you use the machine in a confined space, make sure there is a continuous air turnover.*
- Temperature: 10-32 °C (50-89.6 °F) (humidity to be 54% at 32 °C, 89.6 °F)
- Humidity: 15-80% (temperature to be 27 °C, 80.6 °F at 80%)
- A strong and level base.
- The machine must be level within 5 mm, 0.2 inches: both front to rear and left to right.
- To avoid possible buildup of ozone, make sure to locate this machine in a large well ventilated room that has an air turnover of more than 30 m³/hr/person.

Environments to avoid

- Locations exposed to direct sunlight or other sources of strong light (more than 1,500 lux).

- Locations directly exposed to cool air from an air conditioner or heated air from a heater. (Sudden temperature changes can cause condensation to form inside the machine.)
- Locations close to machines generating ammonia, such as a diazo copy machine.
- Places where the machine will be subject to frequent strong vibration.
- Dusty areas.
- Areas with corrosive gases.

Moving

CAUTION:

- *Unplug the power cord from the wall outlet before you move the machine. While moving the machine, you should take care that the power cord will not be damaged under the machine.*

Important

- r Be careful when moving the machine. Take the following precautions:
 - Turn off the main power. See p.24 “Turning Off the Main Power”.
 - Unplug the power cord from the wall outlet. When you pull out the plug from the socket, grip the plug to avoid damaging the cord, thereby reducing the risk of fire or electric shock.
 - Close all covers and trays, including the front cover and bypass tray.
- r Move the machine carefully. If you do not, it could be damaged and stored files might be lost.

- r Do not take off the holding stand.
- r Protect the machine from strong shocks. Impact can damage the hard disk and cause stored files to be lost. As a precautionary measure, files should be copied to another computer.

Power Connection

⚠ **WARNING:**

- **Connect the machine only to the power source described on the inside front cover of this manual. Connect the power cord directly into a wall outlet and do not use an extension cord.**
- **Do not damage, break or make any modifications to the power cord. Do not place heavy objects on it. Do not pull it hard nor bend it more than necessary. These actions could cause an electric shock or fire.**

⚠ **CAUTION:**

- *Unplug the power cord from the wall outlet before you move the machine. While moving the machine, you should take care that the power cord will not be damaged under the machine.*

⚠ **CAUTION:**

- *When you disconnect the power plug from the wall outlet, always pull the plug (not the cable).*

- When the main power switch is in the stand-by position, the optional anti-condensation heaters are on. In an emergency, unplug the machine's power cord.

- When you unplug the power cord, the anti-condensation heaters turn off.
- Make sure the plug is inserted firmly in the wall outlet.
- Voltage must not fluctuate by more than 10%.
- The wall outlet shall be installed near the machine and shall be easily accessible.

Access to the Machine

Place the machine near the power source, providing the clearance areas shown.

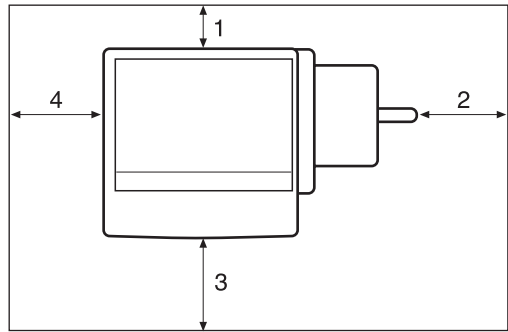

- 1. Rear: 10 cm (4") or more**
- 2. Right: 10 cm (4") or more**
- 3. Front: 75 cm (29.6") or more**
- 4. Left: 10 cm (4") or more**

Note

- r For the required space when options are installed, contact your service representative.

Maintaining Your Machine

If the exposure glass, exposure glass cover, or ADF belt is dirty, copy clarity may be reduced. Clean these parts if they are dirty.

✓ Cleaning the machine

Wipe the machine with a soft, damp cloth, and then wipe it with a dry cloth to remove the water.

⚠ Important

- r Do not use chemical cleaners or organic solvents, such as thinner or benzene. If such substances get inside the machine or melt plastic parts, a failure might occur.
- r Do not clean parts other than those explicitly specified in this manual. Other parts should only be cleaned by your service representative.

Cleaning the Exposure Glass

Gdsh050j.eps



Clean 1 and 2.

Cleaning the Exposure Glass Cover

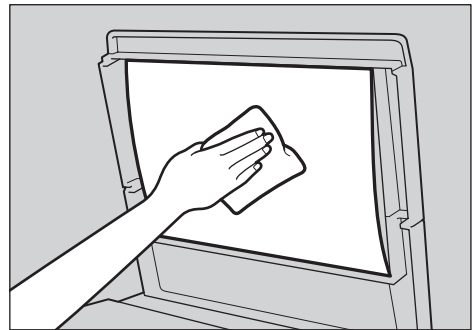

Cleaning the Auto Document Feeder

Gdsh130j.eps

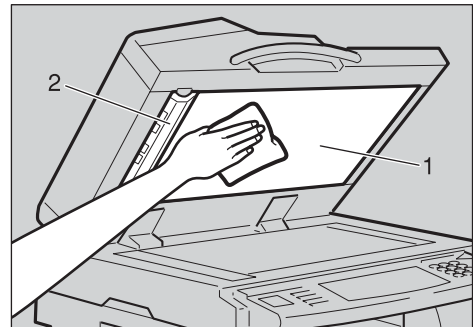

Clean 1 and 2.

Changing the Photoconductor Unit (PCU)

Only use the photoconductor unit made specifically for this machine. Follow the procedure below to change the unit.

Important

r Be sure to unplug the power cord from the outlet before changing the photoconductor unit.

A Open the front door, duplex unit, and then transfer unit right cover.

B Push the development unit to the left, and then pull out the photoconductor unit.

C Remove the harness clamps on the charge unit and cleaning unit of the new photoconductor unit.

D Push the development unit to the left, and then install the new photoconductor unit.

Note

r If the copy quality is still not satisfactory after replacing the photoconductor unit, contact your service representative.

Other Functions

Inquiry

The inquiry function lets you check the telephone numbers to contact for repairs, or ordering consumables such as toner. Be sure to contact your service engineer to verify the following:

- v **Consumables**
 - Telephone No. to order
 - Toner
 - Staple
 - Staple (Centre)
 - TX Stamp Name
- v **Machine Maintenance/Repair**
 - Telephone No.
 - Serial No. of Machine
- v **Sales Representative**
 - Telephone No.

1 Press the [User Tools/Counter] key.



2 Press [Inquiry].



Inquiry information appears.

Printing inquiry information

A Press [Print Inquiry List].



B Press the [Start] key.

Inquiry information prints out.

3 Press [Exit].

4 Press [Exit].

Changing the Language

You can change the language used on the display. English is set as default.

1 Press the [User Tools/Counter] key.



2 Press [Français].



The language is changed to French.

3 Press [Exit].

The menu appears in French.

Counter

Displaying the Total Counter

You can display the total counter value used for all functions.

- 1 Press the [User Tools/Counter] key.



- 2 Press [Counter].



- 3 To print a counter list, press [Print Counter List].



- 4 Press the [Start] key.
A counter list prints out.

7. Entering Text

Entering Text

This section describes how to enter characters. When you enter a character, it appears at the position of the cursor. If there is a character already at the cursor position, the entered character appears before that.

Available Characters

- Alphabetic characters
ABCDEFGHIJKLMNOPQRSTUVWXYZabcdefghijklmnopqrstuvwxyz
- Symbols
- Numerals
0123456789

Keys

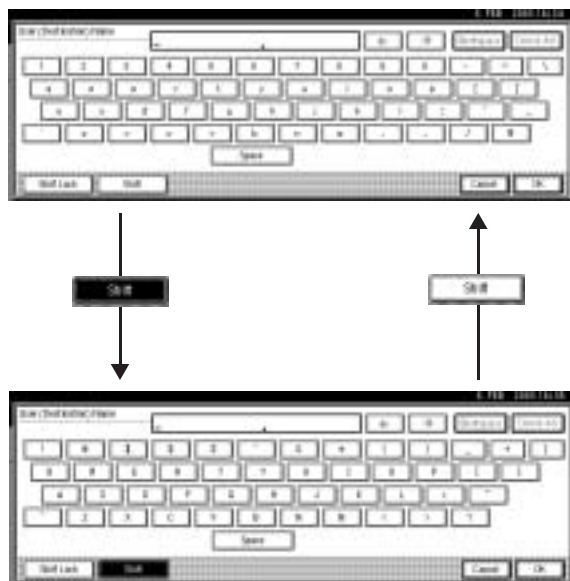

Note

- r When entering uppercase or lowercase letters continuously, use [Shift Lock] to lock the case.

How to Enter Text

Entering letters

- 1** Press [Shift] to switch between uppercase and lowercase.
 - 2** Press the letters you want to enter.
-

Deleting characters

- 1** Press [Backspace] or [Delete All] to delete characters.

Security

Confidential information is always at risk of being copied without permission or subject to unauthorized access through the network. To protect documents from such intrusion, not only can passwords be set, but also the Extended Security function can be used to strengthen security.

For those who require increased document protection, we recommend the Extended Security function.

Primary Security Functions

- ✓ **Protecting Stored Documents**
Protects documents with a password when using Document Server or Locked Print. Furthermore, the Extended Security function can protect against password-generating cracking. See p.149 “Extended Security Function”.
- ✓ **Protecting Image Data Remaining in Memory**
Protects image data remaining in memory. When a copy or print job is completed, or a job is canceled, the data is secure.
- ✓ **Protecting against Unauthorized Access via Phone Line**
Accepts only facsimile calls.
- ✓ **Authenticating Administrator**
Protects essential functions for administrating document security using an access code. See p.60 “Key Operator Code”.

Extended Security Function

By setting a password, document operations such as printing, deleting, or delivering can be restricted to authorized users and denied to others. However, passwords can be cracked. When the Extended Security function is used, entering the wrong password 10 times will lock that document, protecting it from unauthorized access.

To unlock documents, see p.151 “Unlocking a locked document”.

Documents that can be protected by the Extended Security function are as follows (all documents must be set with a password to be protected using this function):

- √ Documents stored in the Document Server by the following functions
 - Document Server function
 - Copier function
 - Fax transmission
 - Scanner function
 - Printer driver
- √ Documents stored from the printer driver using the Locked Print function

Reference

For information about Document Server, see p.33 “Document Server”.

For information about Locked Print, see “Locked Print”, *Printer Reference 2*, or the printer driver Help.

Note

- r Once a document is locked, it will reject the correct password until it is unlocked.
- r When the Extended Security function is on, delivery server settings cannot be changed. Turn the function off to change the settings.

Setting Extended Security

Preparation

The Extended Security setting is not available unless the access code set in the Key Operator Code settings of the System Settings has six or more digits. See p.60 “Key Operator Code”.

Note

- r To ensure increased document protection under the Extended Security setting, we recommend you select **[All Initial Settings]** when programming a key operator code.

1 Press the **[User Tools/Counter]** key.

2 On the display panel, press **[System Settings]**, and then press **[Key Operator Tools]**.

3 Press **[Extended Security]**. Press **[ON]**, and then **[OK]**.

The Extended Security function is enabled and the security mark  appears in the upper right of the display panel.



4 Press the **[User Tools/Counter]** key to finish.

Unlocking a locked document

Unlock a document that was locked because a wrong password was entered multiple times, making it available for authorized users to access again.

- 1** Press the [User Tools/Counter] key.
- 2** On the display panel, press [System Settings], and then press [Password Management for Stored Files].
- 3** Press [OK] under **Unlock Files**.
The document is unlocked.
- 4** Press the [User Tools/Counter] key to finish.

Temporarily Disabling Document Security

If you forget a password, document protection can be temporarily disabled, making documents available for operations such as setting new passwords or deleting.

Important

- r When operations are complete, be sure to press [Do not Unlock] under Temporarily Unlock Files, protecting the document by password again.

Note

- r For a document stored using Locked Print, only document deletion is available when protection is disabled.

- 1** Press the [User Tools/Counter] key.
- 2** On the display panel, press [System Settings], and then press [Password Management for Stored Files].
- 3** Press [Unlock] under **Temporarily Unlock Files**.

Note

- r Protection can be disabled for only three minutes. Access the document, set a new password, and perform any other necessary operations to the document within that time. Documents will automatically return to the password-protected condition after three minutes.

- 4** Press the [User Tools/Counter] key to finish.

Operating Environment and Notes

Security for this machine is assured on the premises that the machine is used under the following conditions:

Operating Environment

- The condition of the machine is normal. (For example, it is not damaged, modified, or lacking components.)
- When the machine is connected to a network, the machine is protected from illegitimate access including unauthorized packet sniffing.
- The machine is managed by an administrator with thorough knowledge of the machine and capable of providing the proper conditions under which users can use the machine safely.

For Administrator

- This machine does not protect against illegitimate actions on the network. To avoid any risks on the network, further security is required.
- Security of this machine cannot be assured if any hardware component is detached or replaced with an inappropriate component. If these things have the possibility of occurring, other security measures are necessary.
- Regularly check that the Extended Security function is on. While the machine is in this mode, the security mark  is displayed at the upper right of the display panel. Be sure to check it particularly after the machine is moved or a power failure occurs. See p.150 “Setting Extended Security”.
- Avoid using a single number or consecutive numbers for an access code such as “00000000” or “12345678”. Since the numbers like this are easy to guess, using them will not provide the appropriate level of security.
- Remote document management using SmartNetMonitor for Admin is not available when the Extended Security function is on.
- User code is a function to help manage the use of the machine. It is not to protect confidential documents from others. See p.70 “User Code”.
- As for using the delivery function, the security of this machine can assure only the protection of documents having a password set and stored in the Document Server. Be sure to select the destination correctly when delivering documents.

For User

- Be careful not to let anyone know your password, especially when entering a password or recording it. Keep any record of your password in a safe place.
- Avoid using a single number or consecutive numbers for a password such as “0000” or “1234”, since the numbers like this are easy to guess, so using them will not provide a worthwhile level of security.
- A document accessed with a correct password remains selected even after operations are complete, and it can be accessed by other users. To stop this, be sure to press the **[Clear Modes]** key to cancel the document selection.
- The user name used when adding a document to the Document Server is to identify the document creator and type. It is not to protect confidential documents from others.
- Before scanning documents using the scanner function, make sure all other operations are complete.

9. Specifications

Main unit

- ✓ **Configuration:**
Desktop
- ✓ **Photosensitivity type:**
OPC drum
- ✓ **Original scanning:**
One-dimensional solid scanning system through CCD
- ✓ **Copy process:**
Dry electrostatic transfer system
- ✓ **Development:**
Dry two-component magnetic brush development system
- ✓ **Fusing:**
Heating roll pressure system
- ✓ **Resolution:**
600 dpi
- ✓ **Exposure glass:**
Stationary original exposure type
- ✓ **Original reference position:**
Rear left corner
- ✓ **Warm-up time:**
From the main power switch
 - Type 1: 15 seconds or less (20 °C) (When Facsimile or Printer is installed: 18 seconds or less (20 °C))
 - Type 2: Less than 20 seconds (20 °C)From the operation switch
 - Type 1: Less than 10 seconds (20 °C)
 - Type 2: Less than 15 seconds (20 °C)
- ✓ **Originals:**
Sheet/book/objects
- ✓ **Maximum original size:**
A3☐, 11" × 17"☐

✓ **Copy paper size:**

- Trays: A3☐ – A5☐, 11" × 17"☐ – 5¹/₂" × 8¹/₂"☐
- Bypass: A3☐ – A6☐, 11" × 17"☐ – 5¹/₂" × 8¹/₂"☐
- Bypass (custom size):
Vertical: 100 – 297 mm, 4 – 11.7 in
Horizontal: 148 – 600 mm, 5.9 – 23.6 in
- Duplex: A3☐ – A5☐, 11" × 17"☐ – 5¹/₂" × 8¹/₂"☐ (except A5☐, 5¹/₂" × 8¹/₂"☐)
- LCT: A4☐, 8¹/₂" × 11"☐

✓ **Paper weight:**

- Paper tray 1, 2: 64 – 105 g/m², 17 – 28 lb.
- Bypass tray: 52 – 163 g/m², 14 – 43.6 lb.
- Duplex: 64 – 105 g/m², 17 – 28 lb.

✓ **Non-reproduction area:**

- Leading edge: 3 ± 2 mm or less
- Trailing edge: 2 ± 2 mm or less
- Left edge: 2 ± 1.5 mm or less
- Right edge: 2 + 2.5/-1.5 mm or less

✓ **First copy time:**

- Type 1: 4.5 seconds or less
(face up feed, A4☐, 100%, feeding from the tray 1, on the exposure glass, Text·Photo mode, Auto Image Density)
- Type 2: 3.6 seconds or less
(face down feed, A4☐, 100%, feeding from the tray 1, on the exposure glass, Text·Photo mode, Auto Image Density)

✓ **Copying speed: (Type 1)**

- 19 copies/minute (A3☐, 11" × 17"☐)
- 35 copies/minute (A4☐, 8¹/₂" × 11"☐)

✓ **Copying speed: (Type 2)**

- 22 copies/minute (A3☐, 11" × 17"☐)
- 45 copies/minute (A4☐, 8¹/₂" × 11"☐)

v Reproduction ratio:

Preset reproduction ratios:

	Metric version	Inch version
Enlargement	400%	400%
	200%	200%
	141%	155%
	122%	129%
	115%	121%
Full size	100%	100%
Reduction	93%	93%
	82%	85%
	75%	78%
	71%	73%
	65%	65%
	50%	50%
	25%	25%

Zoom: From 25 to 400% in increments of 1%.

v Maximum continuous copy run:

999 sheets

v Paper capacity:

- Tray 1, 2: 550 sheets (72 g/m², 19 lb.)
- Bypass tray: 50 sheets (72 g/m², 19 lb.)

v Power consumption:

- Main unit only

	Type 1	Type 2
Warm-up	about 1.25 kw	about 1.25 kw
Stand-by	about 0.139 kw	about 0.17 kw
During printing	about 1.2 kw	about 1.2 kw
Maximum	less than 1.5 kw	less than 1.5 kw

- Complete system ^{*1}

	Type 1	Type 2
Warm-up	about 1.3 kw	about 1.3 kw
Stand-by	about 0.17 kw	about 0.195 kw
During printing	about 1.4 kw	about 1.4 kw
Maximum	less than 1.5 kw	less than 1.5 kw

^{*1} The complete system consists of the main unit, ADF, internal tray 2, paper tray unit, bridge unit, 2 tray finisher, LCT, fax unit and printer/scanner unit.

✓ **Dimensions (W × D × H up to exposure glass):**
 Type 1, 2: 670 × 650 × 720 mm, 26.4 × 25.6 × 28.3 in

✓ **Space for main unit (W × D):**
 Type 1, 2: 980 × 650 mm, 38.6 × 25.6 in (Bypass tray extender is used for large size paper)

✓ **Noise emission ^{*1}:**
 Sound power level:

- Main unit only

	Type 1	Type 2
Stand-by	Less than 42 dB (A)	Less than 42 dB (A)
Copying	Less than 69 dB (A)	Less than 69 dB (A)

- Complete system ^{*3}

	Type 1	Type 2
Stand-by	Less than 42 dB (A)	Less than 42 dB (A)
Copying	Less than 73 dB (A)	Less than 74 dB (A)

Sound pressure level ^{*2}

- Main unit only

	Type 1	Type 2
Stand-by	Less than 37 dB (A)	Less than 37 dB (A)
Copying	Less than 54 dB (A)	Less than 55 dB (A)

- Complete system ^{*3}

	Type 1	Type 2
Stand-by	Less than 37 dB (A)	Less than 37 dB (A)
Copying	Less than 59 dB (A)	Less than 60 dB (A)

^{*1} The above measurements, made in accordance with ISO 7779 are actual values.

^{*2} Measured at the position of the bystander.

^{*3} The complete system consists of the main unit, ADF, internal tray 2, paper tray unit, bridge unit, 2 tray finisher and LCT.

✓ **Weight:**
 Type 1, 2: Approx. 79 kg, 174.2 lb.

✓ **HDD:**
 20 GB or more









- Capacity for Document Server
 7.6 GB
- Capacity for memory sorting
 5.3 GB
- Capacity for others
 7.1 GB or more

Options

Exposure Glass Cover

Lower this over originals for copying.

Auto Document Feeder

- v **Mode:**
ADF mode, Batch mode, SADF mode, Mixed Size mode, Custom Size Originals mode
- v **Original size:**
 - A3  – B6 JIS   (except two-sided originals of B6 JIS  )
 - 11" × 17"  – 5¹/₂" × 8¹/₂"  
- v **Original weight:**
 - One-sided originals: 40–128 g/m² (11–34 lb.)
 - Two-sided originals: 52–105 g/m² (14–28 lb.)
- v **Maximum number of originals:**
80 sheets (80 g/m², 20 lb.) or less than 11 mm, 0.43 in
- v **Maximum power consumption:**
Less than 60 W (power is supplied from the main unit)
- v **Dimensions (W×D×H):**
570 × 518 × 150 mm, 22.4 × 20.4 × 5.9 in
- v **Weight:**
Approx. 12 kg, 26.5 lb.

 **Note**

- r Specifications are subject to change without notice.

1000-Sheet Finisher

Finisher Upper Tray:

✓ Paper size:

A3, B4 JIS, A4, B5 JIS, A5, B6 JIS, A6, 12" × 18", 11" × 17", 8½" × 14", 10½" × 7¼", 8½" × 13", 8½" × 11", 8" × 13", 8¼" × 13", 5½" × 8½"

✓ Paper weight:

52–163 g/m², 14–43 lb.

✓ Stack capacity:

- 250 sheets (A4 or smaller) (80 g/m², 20 lb.)
- 50 sheets (B4 JIS or larger) (80 g/m², 20 lb.)

Finisher Shift Tray:

✓ Paper size:

A3, B4 JIS, A4, B5 JIS, A5, 12" × 18", 11" × 17", 8½" × 14", 10½" × 7¼", 8" × 13", 8¼" × 13", 5½" × 8½"

✓ Paper weight:

52 – 163 g/m², 14 – 43 lb.

✓ Stack capacity:

- 1,000 sheets (A4 or smaller) (80 g/m², 20 lb.)
- 500 sheets (B4 JIS or larger) (80 g/m², 20 lb.)

✓ Staple capacity:

- 50 sheets (A4 or smaller) (80 g/m², 20 lb.)
- 30 sheets (B4 JIS or larger) (80 g/m², 20 lb.)

✓ Staple paper size:

A3, B4 JIS, A4, B5 JIS, 12" × 18", 11" × 17", 8½" × 14", 8½" × 11", 10½" × 7¼", 8" × 13", 8½" × 13", 8¼" × 13"

✓ Staple paper weight:

64–90 g/m², 17–24 lb.

✓ Staple position:

- 1 staple – 2 positions
- 2 staples – 2 positions

✓ Power consumption:

Less than 50 W (power is supplied from the main unit)

✓ **Dimensions (W × D × H):**

520 × 520 × 790 mm, 20.5 × 20.5 × 31.1 in (including trays)

✓ **Weight:**

Approx. 25 kg, 55.2 lb.

2 Tray Finisher

Finisher Shift Tray 1:

✓ **Paper size:**

A3☐, B4 JIS☐, A4☐☐, B5 JIS☐☐, A5☐☐, B6 JIS☐, A6☐, 11" × 17"☐, 8½" × 14"☐, 8½" × 11"☐☐, 5½" × 8½"☐☐

✓ **Paper weight:**

52 – 163 g/m², 14 – 43 lb.

✓ **Stack capacity:**

- 500 sheets (A4☐☐, B5 JIS☐☐, A5☐, 8½" × 11"☐☐) (80 g/m², 20 lb.)
- 250 sheets (A3☐, B4 JIS☐, 8½" × 14"☐, 11" × 17"☐) (80 g/m², 20 lb.)
- 100 sheets (A5☐, 5½" × 8½"☐☐) (80 g/m², 20 lb.)

Finisher Shift Tray 2:

✓ **Paper size:**

A3☐, B4 JIS☐, A4☐☐, B5 JIS☐☐, A5☐☐, B6 JIS☐, A6☐, 11" × 17"☐, 8½" × 14"☐, 8½" × 11"☐☐, 5½" × 8½"☐☐

✓ **Paper weight:**

52 – 163 g/m², 14 – 43 lb.

✓ **Stack capacity:**

No Staple:

- 2,000 sheets (A4☐, 8½" × 11"☐) (80 g/m², 20 lb.)
- 750 sheets (A3☐, B4 JIS☐, A4☐, B5 JIS☐☐, 11" × 17"☐, 8½" × 14"☐, 8½" × 11"☐) (80 g/m², 20 lb.)
- 500 sheets (A5☐) (80 g/m², 20 lb.)
- 100 sheets (A5☐, 5½" × 8½"☐☐) (80 g/m², 20 lb.)

Staple:

- 1,500 sheets (A4☐, 8½" × 11"☐) (80 g/m², 20 lb.)
- 750 sheets (A3☐, B4 JIS☐, A4☐, B5 JIS☐☐, 11" × 17"☐, 8½" × 14"☐, 8½" × 11"☐) (80 g/m², 20 lb.)
- 500 sheets (A5☐) (80 g/m², 20 lb.)
- 100 sheets (A5☐, 5½" × 8½"☐☐) (80 g/m², 20 lb.)

✓ **Staple capacity:**

- 50 sheets (A4☐☐, B5 JIS☐☐, 8½" × 11"☐☐) (80 g/m², 20 lb.)
- 30 sheets (A3☐, B4 JIS☐, 11" × 17"☐, 8½" × 14"☐) (80 g/m², 20 lb.)

- ✓ **Staple paper size:**
A3, B4 JIS, A4, B5 JIS, 11" × 17", 8½" × 14", 8½" × 11"
- ✓ **Staple paper weight:**
64 – 90 g/m², 17 – 24 lb.
- ✓ **Staple position:**
 - 1 staple – 3 positions
 - 2 staples – 1 position
- ✓ **Power consumption:**
Less than 50 W (power is supplied from the main unit)
- ✓ **Dimensions (W × D × H):**
520 × 520 × 790 mm, 20.5 × 20.5 × 31.1 in (including trays)
- ✓ **Weight:**
Approx. 25 kg, 55.2 lb.

Punch Kit

- ✓ **Paper size**
 - 2 holes: A3 – A5, 11" × 17", 8½" × 14" – 5½" × 8½"
 - 3 holes: A3, B4 JIS, A4, B5 JIS, 11" × 17", 8½" × 11"
 - 4 holes:
 - Metric version: A3, B4 JIS, A4, B5 JIS, 11" × 17", 8½" × 11"
 - Narrow 2 × 2 version: A3 – A5, 11" × 17", 8½" × 14" – 5½" × 8½"
- ✓ **Paper weight:**
 - 4 holes: 52 – 163 g/m², 14 lb. – 43 lb.
 - 2 or 3 holes: 52 – 163 g/m², 14 lb. – 43 lb.
- ✓ **Power consumption:**
26.4 W (power is supplied from the main unit.)
- ✓ **Dimensions (W × D × H):**
142 × 456 × 92 mm, 55.9 × 179.5 × 36.2 in
- ✓ **Weight:**
Approx. 2.9 kg, 6.4 lb

 **Note**

- r Specifications are subject to change without notice.

Booklet Finisher

Finisher Upper Tray:

✓ Paper size:

A3, B4 JIS, A4, B5 JIS, A5, B6 JIS, A6, 11" × 17", 11" × 15", 8½" × 14", 8½" × 11", 5½" × 8½"

✓ Paper weight:

52 – 163 g/m², 14 – 43 lb.

✓ Stack capacity:

- 150 sheets

Finisher Shift Tray:

✓ Paper size:

A3, B4 JIS, A4, B5 JIS, A5, 11" × 17", 8½" × 11"

✓ Paper weight:

52 – 163 g/m², 14 – 43 lb.

✓ Stack capacity:

No Staple:

- 1,000 sheets (A4, B5 JIS, A5, 8½" × 11") (80 g/m², 20 lb.)
- 500 sheets (A3, B4 JIS, A4, 11" × 17", 8½" × 11") (80 g/m², 20 lb.)

Staple:

- 750 sheets (A4, B5 JIS, A5, 8½" × 11") (80 g/m², 20 lb.)
- 500 sheets (A3, B4 JIS, A4, 11" × 17", 8½" × 11") (80 g/m², 20 lb.)

✓ Staple capacity:

- 50 sheets (A4, B5 JIS, 8½" × 11", 7¼" × 10½") (80 g/m², 20 lb.)
- 30 sheets (A3, B4 JIS, A4, 11" × 17", 8½" × 14", 8½" × 13", 8½" × 11") (80 g/m², 20 lb.)

✓ Staple paper size:

A3, B4 JIS, A4, B5 JIS, 11" × 17", 8½" × 14", 8½" × 11"

✓ Staple paper weight:

64 – 80 g/m², 17 – 20 lb.

✓ Staple position:

- 1 staple – 2 positions
- 2 staples – 2 positions

✓ **Saddle stitch**

- Paper size:
A3☐, B4 JIS☐, A4☐, 11" × 17"☐, 8¹/₂" × 11"☐, 8¹/₂" × 14"☐ (80 g/m², 20 lb.)
- Saddle stitching capacity: 15 sheets
- Stack capacity:
2–5 sheets: 25 sets
6–10 sheets: 15 sets
11–15 sheets: 10 sets
- Folding: Centre folding
- Paper weight:
Plain paper: 64 – 80 g/m², 17 – 20 lb.
Cover sheet (one sheet): 64 – 128 g/m², 17 – 34 lb.
- Position: 1 position

✓ **Power consumption:**

Less than 55 W (power is supplied from the main unit)

✓ **Dimensions (W × D × H):**

689 × 603 × 1,055 mm, 27.1 × 23.7 × 41.5 in

✓ **Weight:**

Approx. 50 kg, 110.2 lb. (main unit only)

Bridge Unit

✓ **Dimensions:**

413 × 435 × 126 mm, 16.3 × 17.1 × 5.0 in

✓ **Weight:**

3.6 kg, 7.9 lb.

Internal Tray 2 (1 bin tray)

- ✓ **Number of bins:**
1
- ✓ **Paper size:**
A3☐, B4 JIS☐, B5 JIS☐☐, A5☐, 11" × 17"☐, 8¹/₂" × 14"☐, 8¹/₂" × 11"☐☐, 5¹/₂" × 8¹/₂"☐
- ✓ **Paper capacity:**
125 sheets (80 g/m², 20 lb.)
- ✓ **Paper weight:**
60 – 105 g/m² (16 – 28 lb.)
- ✓ **Maximum power consumption:**
Less than 15 W (power is supplied from the main unit)
- ✓ **Dimensions (W × D × H):**
470 × 565 × 140 mm, 18.5 × 22.2 × 5.5 in
- ✓ **Weight:**
Approx. 4 kg, 8.8 lb.

 **Note**

- r Specifications are subject to change without notice.

Large Capacity Tray

- ✓ **Paper size:**
A4☐, 8¹/₂" × 11"☐
- ✓ **Paper weight:**
60 – 105 g/m², 16 – 28 lb.
- ✓ **Paper capacity:**
1,500 sheets (80 g/m², 20 lb.)
- ✓ **Power consumption:**
Maximum 40 W (power is supplied from the main unit)
- ✓ **Dimensions (W × D × H, option unit):**
390 × 500 × 390 mm, 15.4 × 19.7 × 15.4 in
- ✓ **Weight:**
Approx. 17 kg, 37.5 lb.

 **Note**

- r Specifications are subject to change without notice.

Paper Tray Unit

- ✓ **Paper weight:**
60–105 g/m² (16–28 lb.)
- ✓ **Paper size:**
A3, B4 JIS, A4, B5 JIS, A5, 11" × 17", 8¹/₂" × 14", 8¹/₂" × 13", 8¹/₂" × 11", 8¹/₄" × 13", 8" × 13", 7¹/₄" × 10¹/₂", 8¹/₄" × 14", 11" × 14", 8" × 10¹/₂", 5¹/₂" × 8¹/₂"
- ✓ **Maximum power consumption:**
Less than 50 W (power is supplied from the main unit)
- ✓ **Paper capacity:**
550 sheets (72 g/m², 19 lb.) × 2 trays
- ✓ **Dimensions (W × D × H):**
540 × 650 × 270 mm, 21.3 × 25.6 × 10.6 in
- ✓ **Weight:**
Approx. 25 kg, 55.2 lb.

 **Note**

- r Specifications are subject to change without notice.

Copy Paper

Recommended Paper Sizes and Types

The following limitations apply to each tray:

Tray type	Paper type and weight	Metric version	Inch version	Paper capacity
Tray 1, 2 Paper tray unit (optional)	64-105 g/m ² (17-28 lb.)	A3☐, A4☐☐, 11" × 17"☐, 8 ¹ / ₂ " × 14"☐, 8 ¹ / ₂ " × 11"☐☐		550 sheets ^{*5}
		*1 A3☐, B4 JIS☐, A4☐☐, B5 JIS☐☐, A5☐, 11" × 17"☐, 8 ¹ / ₂ " × 14"☐, 8 ¹ / ₂ " × 11"☐☐, 5 ¹ / ₂ " × 8 ¹ / ₂ "☐, 7 ¹ / ₄ " × 10 ¹ / ₂ "☐, 8" × 13"☐, 8 ¹ / ₂ " × 13"☐, 8 ¹ / ₄ " × 13"☐, 8 ¹ / ₄ " × 14"☐, 11" × 14"☐, 8" × 10 ¹ / ₂ "☐☐		
Bypass tray ^{*1 *2}	Standard paper 60-90.2 g/m ² (16-24 lb.)	A3☐, A4☐☐, A5☐☐, 8" × 13"☐	A3☐, 11" × 17"☐, 8 ¹ / ₂ " × 11"☐☐, 5 ¹ / ₂ " × 8 ¹ / ₂ "☐	50 sheets
		*1 B4 JIS☐, B5 JIS☐☐, B6 JIS☐, A6☐, Postcard☐, 11" × 17"☐, 8 ¹ / ₂ " × 14"☐, 8 ¹ / ₂ " × 11"☐☐, 5 ¹ / ₂ " × 8 ¹ / ₂ "☐, 7 ¹ / ₄ " × 10 ¹ / ₂ "☐, 8 ¹ / ₂ " × 13"☐, 8 ¹ / ₄ " × 13"☐, 11" × 14"☐, 11" × 15"☐, 10" × 14"☐, 10" × 15"☐, 8" × 10"☐☐, 8" × 10 ¹ / ₂ "☐☐	*1 B4 JIS☐, A4☐☐, B5 JIS☐☐, A5☐☐, B6 JIS☐, A6☐, Postcard☐, 8 ¹ / ₂ " × 14"☐, 7 ¹ / ₄ " × 10 ¹ / ₂ "☐, 8 ¹ / ₂ " × 13"☐, 8 ¹ / ₄ " × 13"☐, 11" × 14"☐, 11" × 15"☐, 10" × 14"☐, 10" × 15"☐, 8" × 10"☐☐, 8" × 10 ¹ / ₂ "☐☐	
		Custom size ^{*8} Vertical: 100-297 mm Horizontal: 148-600 mm ^{*9}	Custom size ^{*8} Vertical: 3.9-11.6 in Horizontal: 5.8-23.4 in ^{*9}	
Thin paper ^{*5} 52-59 g/m ² (14-16 lb.)	52-59 g/m ² (14-16 lb.)	A3☐, A4☐☐, A5☐☐, 8" × 13"☐	A3☐, 11" × 17"☐, 8 ¹ / ₂ " × 11"☐☐, 5 ¹ / ₂ " × 8 ¹ / ₂ "☐	50 sheets
		Custom size ^{*8} Vertical: 100-297 mm Horizontal: 148-600 mm ^{*9}	Custom size ^{*8} Vertical: 3.9-11.6 in Horizontal: 5.8-23.4 in ^{*9}	
Thick paper ^{*3 *5 *7} 91-163 g/m ² (24-43.5 lb.)	91-163 g/m ² (24-43.5 lb.)	A3☐, A4☐☐, A5☐☐, 8" × 13"☐	A3☐, 11" × 17"☐, 8 ¹ / ₂ " × 11"☐☐, 5 ¹ / ₂ " × 8 ¹ / ₂ "☐	25 sheets
		*8 Custom size Vertical: 100-297 mm Horizontal: 148-600 mm ^{*9}	*8 Custom size Vertical: 3.9-11.6 in Horizontal: 5.8-23.4 in ^{*9}	

Tray type	Paper type and weight	Metric version	Inch version	Paper capacity
Bypass tray ^{*1 *2}	Translucent paper ^{*4 *5}	A3☐, A4☐☐, A5☐☐, 8" × 13"☐	A3☐, 11" × 17"☐, 8½" × 11"☐☐, 5½" × 8½"☐	40 sheets
	OHP transparencies ^{*3 *4}	A4☐	8½" × 11"☐	20 sheets
	Label paper (adhesive labels)	A3☐, A4☐☐, A5☐☐, 8" × 13"☐	A3☐, 11" × 17"☐, 8½" × 11"☐☐, 5½" × 8½"☐	1 sheet
LCT (optional) ^{*5 *6}	60-105 g/m ² (16-28 lb.)	A4☐, 8½" × 11"☐		1500 sheets

^{*1} See p.127 “To adjust the paper size to a size not indicated on the paper size selector”

^{*2} When copying onto custom size paper, you need to specify vertical and horizontal dimensions. See “Copying from the Bypass Tray”, *Copy Reference*.

^{*3} Select [OHP Sheet] or [Thick Paper] in the display panel. See “Copying from the Bypass Tray”, *Copy Reference*.

^{*4} Placing one sheet at a time is recommended. See “Copying from the Bypass Tray”, *Copy Reference*.

^{*5} When loading paper, make sure the top of the stack is not higher than the limit mark of the paper tray.

^{*6} The paper guide is immovable. If you want to change the size of paper placed in this tray, contact your service representative.

^{*7} If you want to use thick (128–163 g/m², 34 lb.–43.5 lb.) paper, select [Thick Paper] on the display panel. See “Copying from the Bypass Tray”, *Copy Reference*.

^{*8} With paper longer than 433 mm, misfeeds, jams and creasing may occur. Make sure that paper is placed correctly so that it feeds in straight.

^{*9} The horizontal size is 148–432 mm (5.8"–17") when the booklet finisher is installed.

 **Important**

r If you use damp or curled paper, a misfeed may occur.

 **Note**

- r Load paper into the Tray 1-4 with the print side up.
- r Place paper in the LCT and bypass tray with the print side down.
- r When using the bypass tray, it is recommended to set the paper orientation to ☐.
- r When loading OHP transparencies, check the front and back of the sheets, and place them correctly, or a misfeed might occur. Set the paper orientation to ☐ and select A4☐, 8½" × 11"☐ as paper size.
- r When using OHP transparencies, fan them for each use. If you store the sheets in the tray, they may adhere and may cause feeding problems.
- r When copying onto OHP transparencies, remove copied sheets one by one.
- r If multiple-sheet jams occur, load the paper sheet by sheet.
- r Postcards should be fed using the bypass tray. Select [Thick Paper] on the display panel. See “Copying from the Bypass Tray”, *Copy Reference*.
- r When copying onto letterhead paper, the paper placing orientation is different depends on which function you are using. See p.112 “Orientation-Fixed Paper or Two-Sided Paper”.

- r If you load paper of the same size in the same orientation in two or more trays, the machine automatically shifts to the other tray when the first tray in use runs out of paper. This function is called “Auto Tray Switching”. (However, if one tray has recycled or special paper, the settings of the other trays must be the same for Auto Tray Switching to work.) This saves interrupting a copy run to replenish paper when making a large number of copies. See “General Features 1/4 Auto Tray Switching”, *Copy Reference* and p.55 “Tray Paper Size: Tray 1–4”.
- r The paper types you can select in System Settings are only general classifications. Copy quality for every kind of paper in a classification is not guaranteed. See p.169 “Unusable Paper” for details.

Unusable Paper

CAUTION:

- *Do not use aluminum foil, carbon paper, or similar conductive paper to avoid a fire or machine failure.*

Important

- r To prevent faults, do not use any of the following kinds of paper:
 - Paper for inkjet printers
 - Thermal fax paper
 - Art paper
 - Aluminum foil
 - Carbon paper
 - Conductive paper
 - Colored OHP transparencies
 - Paper with perforated lines
 - Hemmed-edge paper
- r Do not use paper designed for inkjet printers, as these may stick to the fusing unit and cause a misfeed.
- r Do not use copy paper that has been already copied onto, faults could occur if you do.

 **Note**

- r To prevent misfeeds, do not use the following kinds of paper:
 - Bent, folded, or creased paper
 - Torn paper
 - Slippery paper
 - Perforated paper
 - Rough paper
 - Thin paper with little stiffness
 - Paper with a dusty surface
- r If you copy onto rough grain paper, the image might be blurred.

Paper Storage

 **Note**

- r When storing paper, the following precautions should always be followed:
 - Do not store paper where it will be exposed to direct sunlight.
 - Avoid storing paper in humid areas (humidity: 70% or less).
 - Store on a flat surface.
- r Do not store paper vertically.
- r Under high temperature and humidity conditions, or low temperature and humidity conditions, store paper in vinyl bags.

INDEX

- 1000-sheet finisher, 18, 160
- 1 bin tray, 18
- 2 Tray finisher, 18, 161

A

- Adding staples, 129
- Adding toner, 113
- Address Book, 67
 - change order*, 63
 - edit title*, 64
 - program/change/delete group*, 63
 - program/change/delete transfer request*, 63
 - select title*, 65
- Address Book Management, 62
- Auto Delete File, 65
- Auto Document Feeder, 18, 159
 - cleaning*, 143
- Auto Off, 25
- Auto off timer, 58
- Auto reset timer
 - copier/Document Server*, 58
 - facsimile*, 59
 - scanner*, 59
 - system*, 58

B

- Booklet finisher, 163
- Bridge unit, 18, 164
- Browse network, 87
- Bypass tray, 16

C

- Changing a group name, 97
- Changing an LDAP server, 104
- Changing a registered e-mail destination, 84
- Changing a registered fax destination, 79
- Changing a registered FTP folder, 91
- Changing a registered SMB folder, 88
- Changing a registered Transfer Station/
Receiving Station, 100
- Changing a user code, 72
- Changing default settings, 50
- Changing paper, 126
- Changing the language, 145
- Changing the paper size, 126

- Check Modes key, 20
- Clear
 - counter per user code*, 61
- Clearing misfeeds, 116
- Clearing the number of prints, 75
- Clear Modes key, 20
- Clear/Stop key, 21
- Combined function operations, 27
- Common key operations, 22
- Control panel, 20
- Copy Count Display, 51
- Copy paper, 167
- Cover sheet tray, 57

D

- Delete
 - all files*, 65
- Deleting a group, 97
- Deleting a registered e-mail destination, 84
- Deleting a registered fax destination, 81
- Deleting a registered FTP folder, 92
- Deleting a registered SMB folder, 89
- Deleting a registered Transfer Station/
Receiving Station, 101
- Deleting a user code, 73
- Display
 - counter*, 61
 - counter per user code*, 61
- Displaying destinations registered in groups, 96
- Displaying the number of prints for each
user code, 73
- Displaying the total counter, 146
- Display panel, 20, 22
- Document Server, 33
 - Deleting*, 43
 - Printing*, 40
 - Using the Document Server*, 35
- Dos and Don'ts, 139

E

- E-mail destination, 82
- Energy Saver key, 20
- Entering text, 147
- Environment, 141
- Exposure glass, 15
 - cleaning*, 143
- Exposure glass cover, 18
 - cleaning*, 143
- Extended security, 60
- Extended Security function, 149
- External charge unit management, 60
- External options, 18

F

- Fax destination, 76
- Finisher
 - 1000-sheet finisher*, 18
 - 2 Tray finisher*, 18
 - Booklet finisher*, 18
- Folders, 85
- Front cover, 16
- FTP, 89
- Function keys, 21
- Function Priority, 51
- Function reset timer, 52
- Function status indicators, 21

I

- Indicators, 20
- Inquiry, 145
- Internal options, 19
- Internal tray, 15
- Internal tray 2, 16, 18
- Interrupt key, 21

K

- Key counter management, 60
- Key Operator Code, 60

L

- Large Capacity Tray, 18, 165
- LCT, 18, 165
- LDAP server, 102
- Loading paper, 110
 - Large Capacity Tray*, 110
 - paper trays*, 110

M

- Machine environment, 141
- Main power indicator, 15, 21
- Main power switch, 15, 23
- Maintaining your machine, 143
- Main unit, 155
- Misfeeds, 116
- Moving, 141
- Multi-Access, 29

N

- Number keys, 21

O

- On indicator, 21
- Operation switch, 21, 23
- Options, 159

P

- Panel off timer, 58
- Panel Tone, 51
- Paper
 - changing*, 126
 - loading*, 110
- Paper tray, 16
- Paper tray priority
 - copier*, 55
 - facsimile*, 55
 - printer*, 55
- Paper tray unit, 18
- Paper type
 - bypass tray*, 56
 - LCT*, 57
 - tray 1-4*, 56
- Password management for stored files, 65
- Power connection, 142
- Prepare stapling, 54
- Print
 - Address Book*, 62
 - counter*, 61
 - counter per user code*, 61
- Printing the number of prints for each user code, 74
- Print Priority, 51
- Program/change LDAP server, 66
- Program key, 20
- Programming an LDAP server, 102
- Protection
 - code*, 93, 94
 - destination*, 93
- Punch kit, 162

R

- Receiving Station, 98
- Registering a fax destination, 77
- Registering an e-mail destination, 82
- Registering a new user code, 70
- Registering a protection code, 93
- Registering a protection code to a group user, 94
- Registering a protection code to a single user, 93
- Registering a Transfer Station/
Receiving Station, 98
- Registering destination information, 68
- Registering destinations to a group, 95
- Registering Folders, 85
- Registering sender information, 69
- Registering the Transfer Request, 98
- Remarks, 139
- Removing a destination from a group, 96
- Removing jammed staples, 134
- Removing punch waste, 138

S

- Safety information, 9
- Sample Copy key, 21
- Saving energy, 25
- Screen contrast knob, 20
- Security, 149
- Set date, 59
- Set time, 59
- # (sharp) key, 21
- size setting, 54
- Slip sheet tray, 57
- SMB, 85
- Specifications, 155
 - 1000-sheet finisher*, 160
 - 2 Tray finisher*, 161
 - Auto Document Feeder*, 159
 - booklet finisher*, 163
 - bridge unit*, 164
 - internal tray 2 (1 bin tray)*, 165
 - Large Capacity Tray (LCT)*, 165
 - main unit*, 155
 - paper tray unit*, 166
 - punch kit*, 162
- Staples
 - adding*, 129
 - removing jammed staples*, 134
- Start key, 21
- System Reset, 28

T

- Toner, 140
 - adding*, 113
 - storage*, 140
- To register an FTP folder, 89
- To register an SMB folder, 85
- Transfer Station, 98
- Tray paper size, 55

U

- Use LDAP server, 66
- User code, 70
 - management*, 59
- User Tools, 50
- User Tools/Counter key, 20
- User Tools (System Settings), 47
- Using FTP to Connect, 89
- Using SMB to Connect, 85

V

- Ventilation holes, 17

W

- Warm Up Notice (copier/Document Server), 51



Network Guide

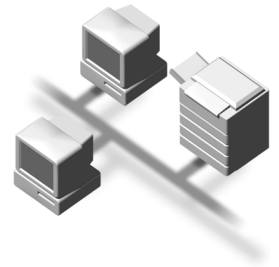

-
- 1** Functions Available over a Network
 - 2** Connecting the Network Cable to the Network
 - 3** Setting Up the Machine on a Network
 - 4** Windows Configuration
 - 5** Using the Printer Function
 - 6** Using SmartNetMonitor for Client
 - 7** Using SmartNetMonitor for Admin
 - 8** Configuring the Network Interface Board Using a Web Browser
 - 9** Appendix

Introduction

This manual describes detailed instructions on the operation and notes about the use of this machine. To get maximum versatility from this machine all operators are requested to read this manual carefully and follow the instructions. Please keep this manual in a handy place near the machine.

Important

Contents of this manual are subject to change without prior notice. In no event will the company be liable for direct, indirect, special, incidental, or consequential damages as a result of handling or operating the machine.

Software Version Conventions Used in This Manual

- NetWare 3.x means NetWare 3.12 and 3.2.
- NetWare 4.x means NetWare 4.1, 4.11, 4.2 and IntranetWare.

Trademarks

Microsoft®, Windows® and Windows NT® are registered trademarks of Microsoft Corporation in the United States and/or other countries.

Apple, AppleTalk, EtherTalk, Macintosh and Mac are registered trademarks of Apple Computer, Inc.

Netscape and Netscape Navigator are registered trademarks of Netscape Communications Corporation.

Novell, NetWare, NDS and NDPS are registered trademarks of Novell, Inc.

PostScript® and Acrobat® are registered trademarks of Adobe Systems, Incorporated.

UNIX is a registered trademark in the United States and other countries, licensed exclusively through X/Open Company Limited.

Citrix® and MetaFrame® are registered trademarks of Citrix Systems, Inc.

Other product names used herein are for identification purposes only and might be trademarks of their respective companies. We disclaim any and all right in those marks.

The proper names of the Windows operating systems are as follows:

- The product name of Windows® 95 is Microsoft® Windows 95.
- The product name of Windows® 98 is Microsoft® Windows 98.
- The product name of Windows® Me is Microsoft® Windows Millennium Edition (Windows Me).
- The product names of Windows® 2000 are as follows:
Microsoft® Windows® 2000 Advanced Server
Microsoft® Windows® 2000 Server
Microsoft® Windows® 2000 Professional
- The product names of Windows® XP are as follows:
Microsoft® Windows® XP Professional
Microsoft® Windows® XP Home Edition
- The product names of Windows Server™ 2003 are as follows:
Microsoft® Windows Server™ 2003 Standard Edition
Microsoft® Windows Server™ 2003 Enterprise Edition
Microsoft® Windows Server™ 2003 Web Edition
- The product names of Windows NT® 4.0 are as follows:
Microsoft® Windows NT® Server 4.0
Microsoft® Windows NT® Workstation 4.0
- RSA Data Security, Inc. MD5 Message-Digest Algorithm
Copyright© 1991-2, RSA Data Security, Inc. Created 1991. All rights reserved.
License to copy and use this software is granted provided that it is identified as the "RSA Data Security, Inc. MD5 Message-Digest Algorithm" in all material mentioning or referencing this software or this function.
License is also granted to make and use derivative works provided that such works are identified as "derived from the RSA Data Security, Inc. MD5 Message-Digest Algorithm" in all material mentioning or referencing the derived work.
RSA Data Security, Inc. makes no representations concerning either the merchantability of this software or the suitability of this software for any particular purpose. It is provided "as is" without express or implied warranty of any kind.
These notices must be retained in any copies of any part of this documentation and/or software.

TABLE OF CONTENTS

Manuals for This Machine	1
How to Read This Manual	3

1. Functions Available over a Network

Using the Printer	5
Using Fax	6
Internet Fax	6
LAN-Fax	7
Network Scanner	8
E-mail	8
Scan to Folder	9
Network Delivery Scanner	10
Network TWAIN Scanner	11
Document Server	12

2. Connecting the Network Cable to the Network

Confirming the Connection	13
Connecting to the Ethernet Interface	14
Connecting to the IEEE 1394 Interface	14
Using the IEEE 802.11b (Wireless LAN)	15

3. Setting Up the Machine on a Network

User Tools Menu (System Settings)	17
Printer (LAN-Fax)	17
Internet Fax	19
E-mail	22
Scan to Folder	25
Network Delivery Scanner	27
Network TWAIN Scanner	29
Document Server	30
Network Configuration	31
Settings You Can Change with User Tools	34

4. Windows Configuration

Configuring TCP/IP	45
Configuring a Windows 95/98/Me Computer	45
Configuring a Windows 2000 Computer	45
Configuring a Windows XP Computer	46
Configuring a Windows NT 4.0 Computer	46
Configuring NetBEUI	47
Configuring a Windows 95/98/Me Computer	47
Configuring a Windows 2000 Computer	47
Configuring a Windows NT Computer	48

5. Using the Printer Function

Printing with Windows	52
Printing with a Windows 2000/XP or Windows NT Print Server.....	52
Printing without a Print Server.....	53
Printing with a Macintosh	56
Changing to EtherTalk	56
Configuring the Printer	57
Changing the Printer Name.....	57
Changing the Zone.....	57
Printing with NetWare	58
Setting Up as a Print Server.....	59
Setting Up as a Remote Printer	63
Setting Up a Client Computer	67

6. Using SmartNetMonitor for Client

SmartNetMonitor for Client	71
---	-----------

7. Using SmartNetMonitor for Admin

SmartNetMonitor for Admin	75
Changing the Network Interface Board Configuration.....	77
Displaying Machine Status.....	77
Locking the Control Panel Menu	78
Selecting the Paper Type.....	78
Managing User Information.....	79
Load Fax Journal	79
Viewing and Deleting Spool Print Jobs	79
Managing Address Information	80
Configuring Energy Saver Mode	80

8. Configuring the Network Interface Board Using a Web Browser

Going to the Top Page	82
Types of Menu Configuration and Mode	83
Verifying the Network Interface Board Settings	85
Configuring the Network Interface Board Settings	86
Using Help on the Web Browser	87
Downloading Help	87

9. Appendix

Remote Maintenance by telnet	89
Using telnet	89
Commands List	90
Using DHCP	104
Using AutoNet	105
SNMP	106
Single-line Messages on the Display Panel	107
Messages without Code Numbers	107
Messages with Code Numbers	108
Understanding Displayed Information	110
Print Job Information	110
Print Log Information	110
Machine Status and Configuration	111
Configuring the Network Interface Board	116
Message List	120
System Log Information	120
When Using Windows Terminal Service/MetaFrame	130
Operating Environment	130
Supported Printer Drivers	130
Limitation	130
Precautions	132
Connecting a Dial-Up Router to a Network	132
NetWare Printing	133
When Using IPP with SmartNetMonitor for Client	134
When the Wireless LAN Board (optional) Is Installed	135
Specifications	136
INDEX	137

Manuals for This Machine

The following manuals describe the operational procedures of this machine. For particular functions, see the relevant parts of the manual.

Note

- Manuals provided are specific to machine type.
- Adobe Acrobat Reader is necessary to view the manuals as a PDF file.
- Two CD-ROMs are provided:
 - CD-ROM 1 “Operating Instructions for Printer/Scanner”
 - CD-ROM 2 “Scanner Driver & Document Management Utilities”

❖ **General Settings Guide**

Provides an overview of the machine and describes System Settings (paper trays, Key Operator Tools, etc.), Document Server functions, and troubleshooting.

Refer to this manual for Address Book procedures such as registering fax numbers, e-mail addresses, and user codes.

❖ **Network Guide (PDF file - CD-ROM1) (this manual)**

Describes procedures for configuring the machine and computers in a network environment.

❖ **Copy Reference**

Describes operations, functions, and troubleshooting for the machine’s copier function.

❖ **Facsimile Reference <Basic Features>**

Describes operations, functions, and troubleshooting for the machine’s facsimile function.

❖ **Facsimile Reference <Advanced Features>**

Describes advanced functions and settings for key operators.

❖ **Printer Reference 1**

Describes system settings and operations for the machine’s printer function.

❖ **Printer Reference 2 (PDF file - CD-ROM1)**

Describes operations, functions, and troubleshooting for the machine’s printer function.

❖ **Scanner Reference (PDF file - CD-ROM1)**

Describes operations, functions, and troubleshooting for the machine’s scanner function.

❖ **Manuals for DeskTopBinder V2 Lite**

DeskTopBinder V2 Lite is a utility included on the CD-ROM labeled “Scanner Driver & Document Management Utilities”.

- DeskTopBinder V2 Lite Setup Guide (PDF file - CD-ROM2)
Describes installation of, and the operating environment for DeskTopBinder V2 Lite in detail. This guide can be displayed from the **[Setup]** dialog box when DeskTopBinder V2 Lite is installed.
- DeskTopBinder V2 Lite Introduction Guide (PDF file - CD-ROM2)
Describes operations of DeskTopBinder V2 Lite and provides an overview of its functions. This guide is added to the **[Start]** menu when DeskTopBinder V2 Lite is installed.
- Auto Document Link Guide (PDF file - CD-ROM2)
Describes operations and functions of Auto Document Link installed with DeskTopBinder V2 Lite. This guide is added to the **[Start]** menu when DeskTopBinder V2 Lite is installed.

❖ **Manuals for ScanRouter V2 Lite**

ScanRouter V2 Lite is a utility included on the CD-ROM labeled “Scanner Driver & Document Management Utilities”.

- ScanRouter V2 Lite Setup Guide (PDF file - CD-ROM2)
Describes installation of, settings, and the operating environment for ScanRouter V2 Lite in detail. This guide can be displayed from the **[Setup]** dialog box when ScanRouter V2 Lite is installed.
- ScanRouter V2 Lite Management Guide (PDF file - CD-ROM2)
Describes delivery server management and operations, and provides an overview of ScanRouter V2 Lite functions. This guide is added to the **[Start]** menu when ScanRouter V2 Lite is installed.

❖ **Other manuals**

- PS3 Supplement (PDF file - CD-ROM1)
- UNIX Supplement (available from an authorized dealer, or as a PDF file on our Web site)

How to Read This Manual

Symbols

In this manual, the following symbols are used:

 **WARNING:**

This symbol indicates a potentially hazardous situation which, if instructions are not followed, could result in death or serious injury.

 **CAUTION:**

This symbol indicates a potentially hazardous situation which, if instructions are not followed, may result in minor or moderate injury, or damage to property.

* The statements above are notes for your safety.

 **Important**

If this instruction is not followed, paper might be misfed, originals might be damaged, or data might be lost. Be sure to read this.

 **Preparation**

This symbol indicates prior knowledge or preparation is required before operation.

 **Note**

This symbol indicates precautions for operation, or actions to take after mal-operation.

 **Limitation**

This symbol indicates numerical limits, functions that cannot be used together, or conditions in which a particular function cannot be used.

 **Reference**

This symbol indicates a reference.

[]

Keys that appear on the machine's display panel.

Keys and buttons that appear on the computer's display.

[]

Keys built into the machine's control panel.

Keys on the computer's keyboard.

1. Functions Available over a Network

This machine provides printer, LAN-Fax, Internet Fax, and scanner functions over a network. Using the Document Server function, you can combine copied documents and print jobs into a single document. Not only can you print this document straight away, but you can also store it so it can be printed again whenever needed.

Using the Printer

The network interface board is compatible with NetWare ^{*1} (IPX/SPX, TCP/IP), Windows NT 4.0 (TCP/IP, NetBEUI ^{*2}, IPP ^{*3}), Windows 2000 (TCP/IP, NetBEUI ^{*2}, IPP ^{*3}), Windows XP (TCP/IP, IPP ^{*3}), Windows 95/98/Me (TCP/IP, NetBEUI ^{*2}, IPP ^{*3}), UNIX (TCP/IP), and Macintosh (AppleTalk) protocols. This allows you to operate the machine in a network that uses different protocols and operating systems.

^{*1} If the optional 802.11b interface kit is installed, you can use only infrastructure mode.

^{*2} For NetBEUI, use the SmartNetMonitor for Client port.

^{*3} IPP (Internet Printing Protocol) is a protocol for printing via the Internet.

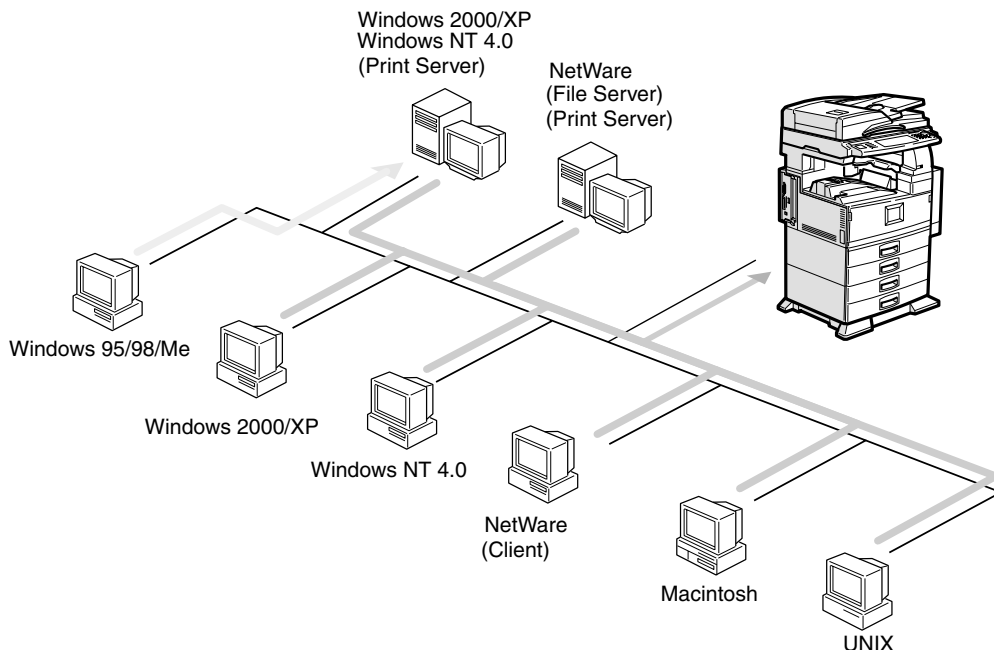

Reference

For details about what settings to make, see p.17 "Setting Up the Machine on a Network".

For details about using this function, see p.49 "Using the Printer Function".

Using Fax

1

Internet Fax

This machine converts scanned document images to e-mail format and transmits the data over the Internet.

Specify the e-mail address instead of the fax number, and then send the document.

E-mail can be received on a fax machine that supports Internet Fax, or on a computer that can receive normal e-mail.

You can also receive e-mails or Internet faxes, and then print or forward them.

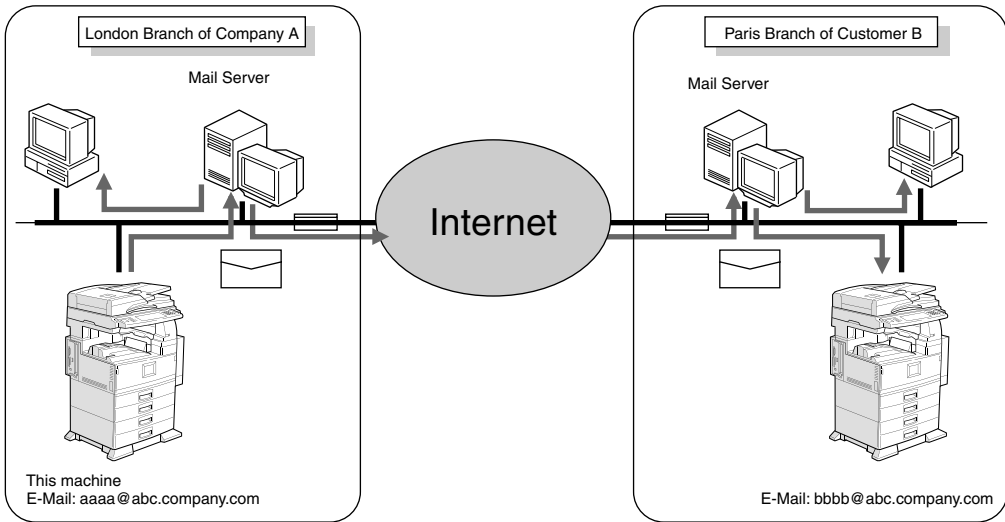

For details about what settings to make, see p.17 "Setting Up the Machine on a Network".

For details about using this function, see "Using Internet Fax Functions", *Facsimile Reference <Basic Features>*.

LAN-Fax

You can fax documents over phone lines from any computer connected to the machine via Ethernet, IEEE 1394 (IP over 1394), or wireless LAN.

To send a fax, print from the Windows application you are working with, select LAN-Fax as the printer, and then specify the destination.

You can also check the sent image data.

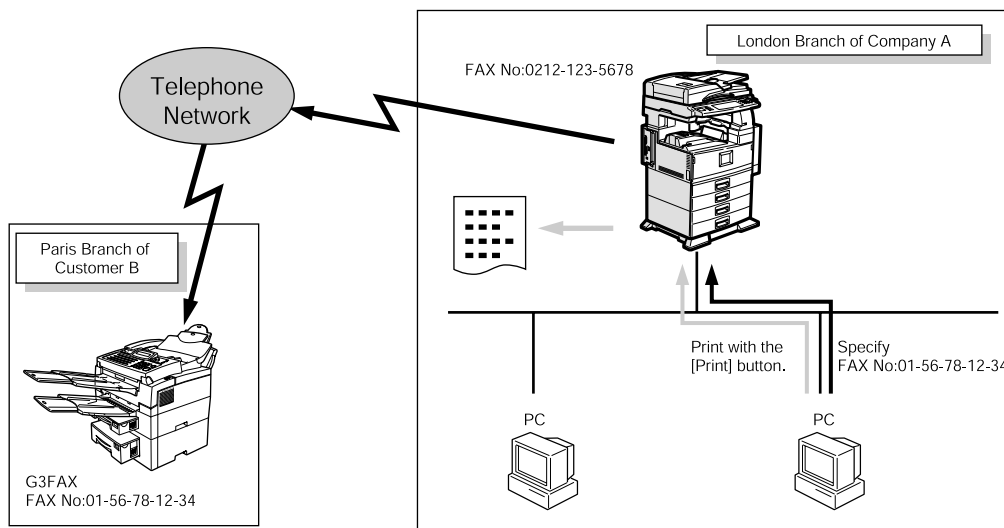

Reference

For details about what settings to make, see p.17 "Setting Up the Machine on a Network".

For details about using this function, see "Sending Fax Documents from Computers", *Facsimile Reference <Advanced Features>*.

Network Scanner

1

E-mail

Scan file attached to an e-mail can be sent using the e-mail system through a LAN or the Internet.

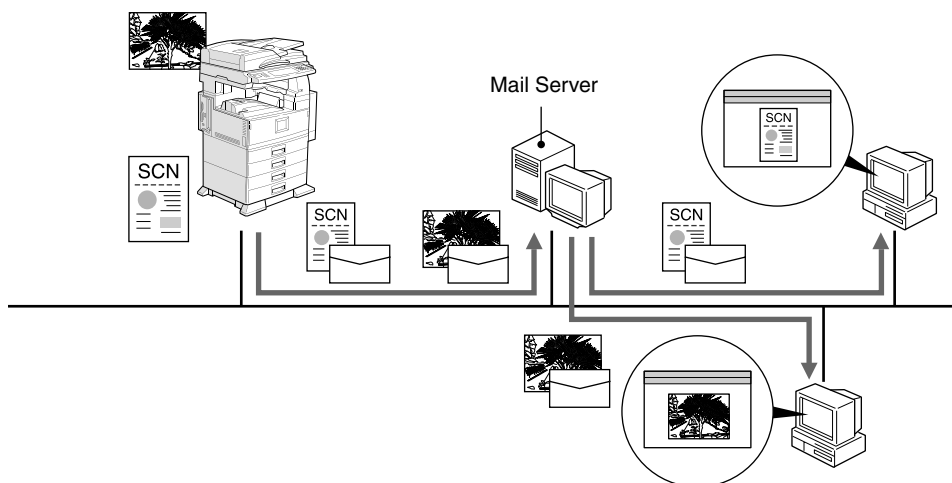

Reference

For details about what settings to make, see p.17 "Setting Up the Machine on a Network".

For details about using this function, see "Sending Scan File by E-mail", *Scanner Reference*.

Scan to Folder

You can send scan file directly to shared folders on computers running Windows or to FTP servers.

1

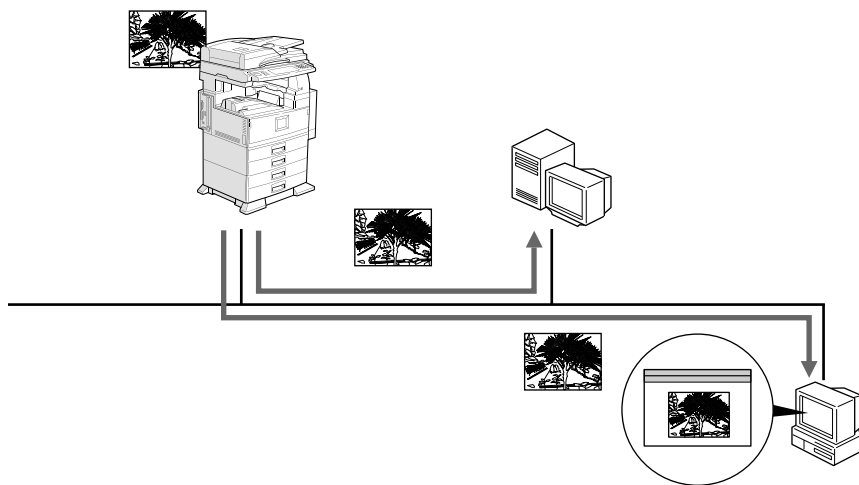

For details about what settings to make, see p.17 “Setting Up the Machine on a Network”.

For details about using this function, see “Sending Scan File by Scan to Folder”, *Scanner Reference*.

Network Delivery Scanner

1

You can use the machine as a delivery scanner for ScanRouter V2 Lite/Professional.

Scan file or document received by fax can be stored in the delivery server, or delivered via the network to specified folders on client computers.

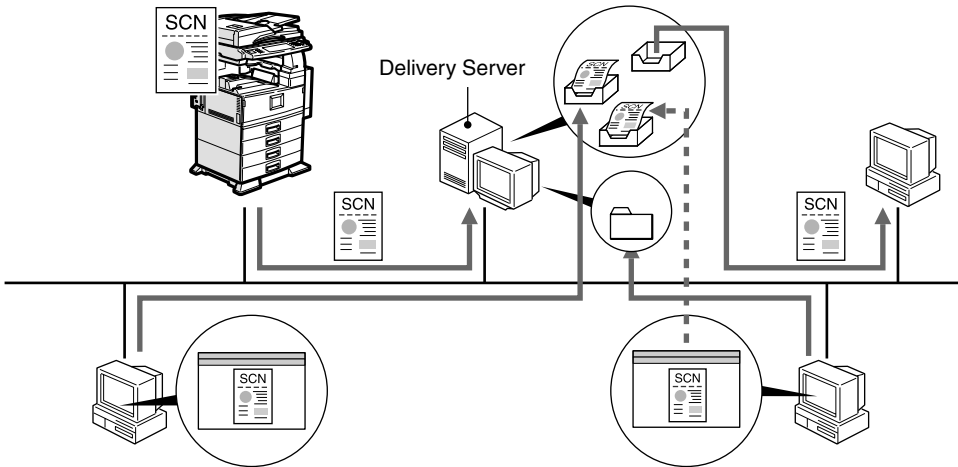

Reference

For details about what settings to make, see p.17 "Setting Up the Machine on a Network".

For details about using this function, see "Using the Network Delivery Scanner Function", *Scanner Reference*.

Network TWAIN Scanner

You can use the scanning function of this machine from a computer connected via a network (Ethernet, IEEE 1394(IP over 1394), or IEEE 802.11b (wireless LAN)).

You can scan documents the same way you would if you were using a scanner connected directly to your computer.

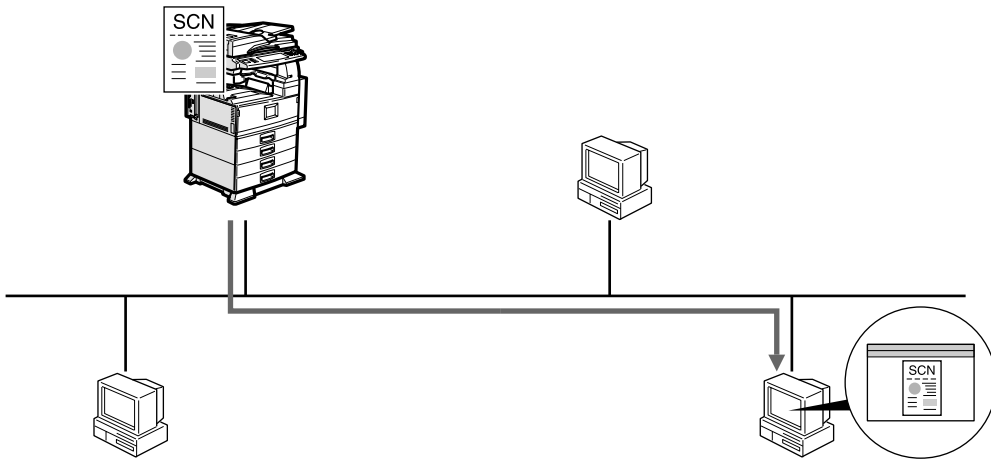

Reference

For details about what settings to make, see p.17 "Setting Up the Machine on a Network".

For details about using this function, see "Using the Network TWAIN Scanner Function", *Scanner Reference*.

Document Server

1

You can store copy, fax, printer, and scanner documents on the hard disk. Using DeskTopBinder V2 Lite or a Web browser, you can browse, print, delete, or copy these documents over a network.

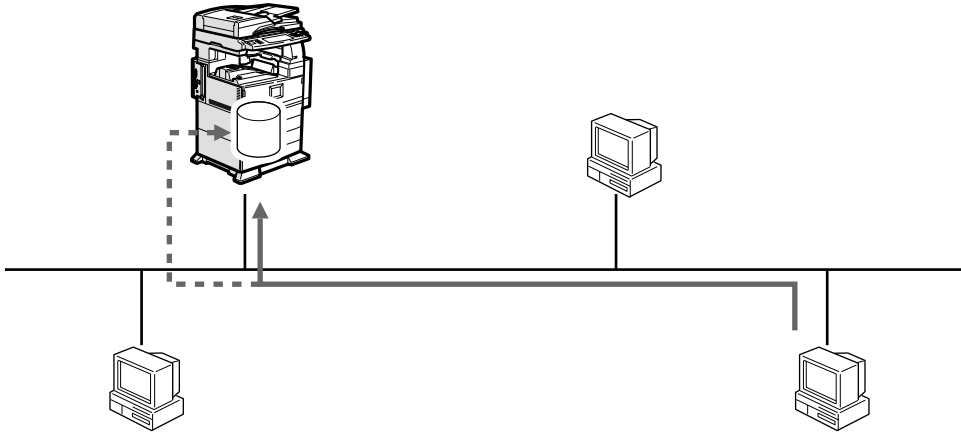

Reference

For details about what settings to make, see p.17 "Setting Up the Machine on a Network".

For more information about Document Server operation from the printer, see "Using the Document Server", *Printer Reference 2*.

For more information about Document Server operation from the facsimile, see "Using the Document Server", *Facsimile Reference <Advanced Features>*.

For more information about Document Server operation from the scanner, see "Using the Document Server Function", *Scanner Reference*.

For all information about Document Server operation, see "Using the Document Server", *General Settings Guide*.

For more information about DeskTopBinder V2 Lite, see the manuals for DeskTopBinder V2 Lite.

2. Connecting the Network Cable to the Network

Confirming the Connection

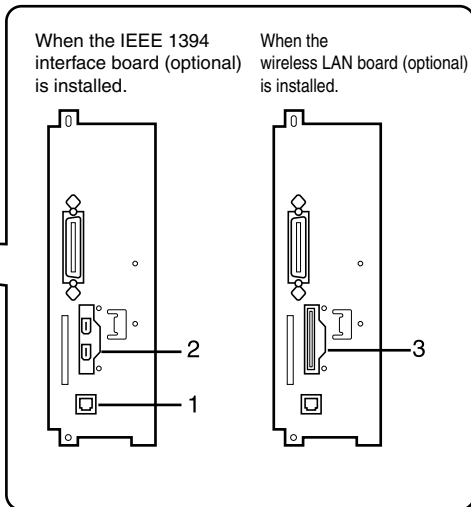
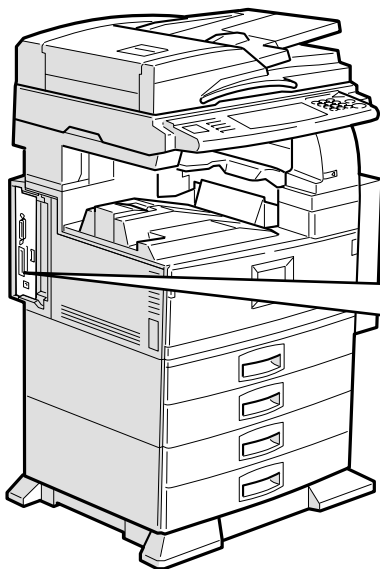

1. 10BASE-T/100BASE-TX port

Port for connecting the 10BASE-T or 100BASE-TX cable

2. IEEE 1394 ports (optional)

Ports for connecting the IEEE 1394 interface cable

3. Wireless LAN port (optional)

Port for using the wireless LAN

Note

- The IEEE 1394 interface board (optional) and the IEEE 802.11b (wireless LAN) board (optional) cannot be installed at the same time.

2

Connecting to the Ethernet Interface

The network interface board supports 10BASE-T or 100BASE-TX connections.

1 Turn off the main power switch.

Important

- ❑ Make sure the main power is off. See “Turning On the Power”, *General Settings Guide*.

2 Connect the Ethernet interface cable to the 10BASE-T/100BASE-TX port.

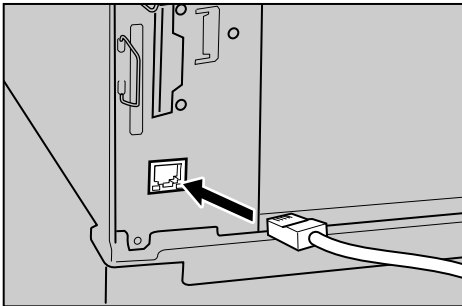

3 Turn on the main power switch.

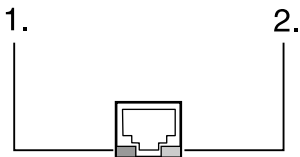

1. Indicator (green)

Remains green when the machine is properly connected to the network.

2. Indicator (yellow)

Turns yellow when 100 BASE-TX is operating. Turns off when 10 BASE-T is operating.

Connecting to the IEEE 1394 Interface

Important

- ❑ Before making the connection, touch the metallic part to ground yourself.

Note

- ❑ Use the interface cable supplied with the IEEE 1394 interface board (optional).
- ❑ Make sure the interface cable is not looped.

1 Connect the IEEE 1394 interface cable to the IEEE 1394 ports.

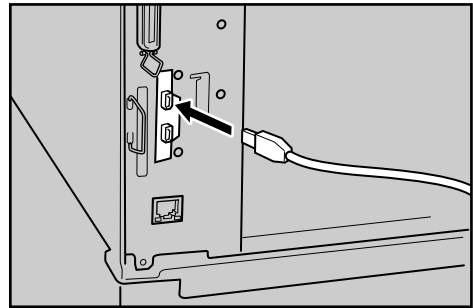

Note

- ❑ Two interface ports are available for connecting the IEEE 1394 interface cable, either is suitable.

Using the IEEE 802.11b (Wireless LAN)

1 Make sure the LED of the IEEE 802.11b card is lit.

❖ When using in infrastructure mode

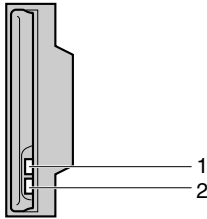

1. If [LAN Type] on the [Interface Settings]/[Network] screen is not set to [IEEE 802.11b], it does not light, even if the main power is on.

2. If it is connected properly to the network, the LED is green when in infrastructure mode. If the LED is blinking, the machine is searching for devices.

❖ When using in ad hoc mode/802.11 ad hoc mode

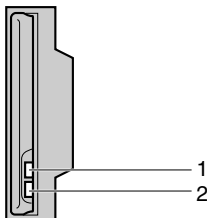

1. If the IEEE 802.11b card is working, it is lit in orange.

2. If it is connected properly to the network, the LED is green when in ad hoc mode or 802.11 ad hoc mode. If the LED is blinking, the machine is searching for devices. The LED will light after a few seconds.

2 Print the configuration page to verify settings.

Reference

For more information about printing a configuration page, see *Printer Reference 2*.

Checking the machine's radio wave status

You can check the machine's radio wave status using the control panel.

To check the radio wave status, press [IEEE 802.11b] under [LAN Type] on the [Network] screen.

1 Press the [User Tools/Counter] key.

2 Press [System Settings].

3 Press [Interface Settings].

4 Press [IEEE 802.11b].

5 Press [Wireless LAN Signal].

The machine's radio wave status appears.

6 After checking radio wave status, press [Exit].

7 Press the [User Tools/Counter] key to return to the User Tools/Counter menu.

3. Setting Up the Machine on a Network

User Tools Menu (System Settings)

This section describes the network settings you can change with User Tools (System Settings). Make settings according to functions you want to use and the interface to be connected.

Important

- These settings should be made by the systems administrator, or after consulting with the systems administrator.

Reference

For details about settings, see p.34 “Settings You Can Change with User Tools”

❖ Viewing the Information Displayed in the List

- These items must be set to use the function. Be sure to set them before attempting to use the corresponding function.
- These items must be set if required.

Printer (LAN-Fax)

Interface	Settings		
Ethernet	Interface Settings/Network See p.34 “Interface Settings/Network”.	IP Address	●
		Gateway Address	○
		DNS Configuration	○
		WINS Configuration	○
		NW Frame Type	○
		LAN Type *2	●
		Ethernet Speed	○
		Effective Protocol *3	●
		Host Name	○
		Domain Name	○

Interface	Settings		
IEEE 1394 (IP over 1394)	Interface Settings/IEEE 1394 ^{*1} See p.36 "Interface Settings/IEEE 1394".	IP Address	●
		IP over 1394	●
		WINS Configuration	○
		Host Name	○
		Domain Name	○
	Interface Settings/Network See p.34 "Interface Settings/Network".	Gateway Address	○
		DNS Configuration	○
		Effective Protocol ^{*3}	●
IEEE 802.11b (wireless LAN)	Interface Settings/Network See p.34 "Interface Settings/Network".	IP Address	●
		Gateway Address	○
		DNS Configuration	○
		WINS Configuration	○
		NW Frame Type	○
		LAN Type ^{*2}	●
		Ethernet Speed	○
		Effective Protocol ^{*3}	●
		Host Name	○
	Domain Name	○	
	Interface Settings/IEEE 802.11b ^{*2} See p.37 "Interface Settings/IEEE 802.11b".	Communication Mode	●
		SSID Setting	○
		Channel	○
		WEP (Encryption) Setting	○
		Transmission Speed	○

^{*1} Appears when the IEEE 1394 interface board (optional) is installed.

^{*2} Appears when the IEEE 802.11b (wireless LAN) board (optional) is installed.
If Ethernet and IEEE 802.11b (wireless LAN) are both connected to the machine, the selected interface has priority.

^{*3} Check **[Effective]** is selected for TCP/IP.

Internet Fax

Interface	Settings		
Ethernet	Interface Settings/Network See p.34 "Interface Settings/Network".	IP Address	●
		Gateway Address	●
		DNS Configuration	○
		WINS Configuration	○
		LAN Type *2	●
		Ethernet Speed	○
		Effective Protocol *5	●
		Host Name	○
		Domain Name	○
	File Transfer See p.38 "File Transfer".	SMTP Server *3	●
		SMTP Authentication	○
		POP before SMTP	○
		Reception Protocol *4	●
		POP3/ IMAP4 Settings *6	○
		Key Operator's E-mail Address *8	○
		E-mail Reception Port *4 *7	●
		E-mail Reception Interval	○
		Max. Reception E-mail Size	○
		E-mail Storage in Server	○
		Program/ Change/ Delete E-mail	○
Program/ Change/ Delete Subject	○		
E-mail Account *3 *4	●		

Interface	Settings		
IEEE 802.11b (wireless LAN)	Interface Settings/Network See p.34 "Interface Settings/Network".	IP Address	<input checked="" type="radio"/>
		Gateway Address	<input checked="" type="radio"/>
		DNS Configuration	<input type="radio"/>
		WINS Configuration	<input type="radio"/>
		LAN Type *2	<input checked="" type="radio"/>
		Ethernet Speed	<input type="radio"/>
		Effective Protocol *5	<input checked="" type="radio"/>
		Host Name	<input type="radio"/>
		Domain Name	<input type="radio"/>
	Interface Settings/IEEE 802.11b *2 See p.37 "Interface Settings/IEEE 802.11b".	Communication Mode	<input checked="" type="radio"/>
		SSID Setting	<input type="radio"/>
		Channel	<input type="radio"/>
		WEP (Encryption) Setting	<input type="radio"/>
		Transmission Speed	<input type="radio"/>
	File Transfer See p.38 "File Transfer".	SMTP Server *3	<input checked="" type="radio"/>
		SMTP Authentication	<input type="radio"/>
		POP before SMTP	<input type="radio"/>
		Reception Protocol *4	<input checked="" type="radio"/>
		POP3/ IMAP4 Settings *6	<input type="radio"/>
		Key Operator's E-mail Address *8	<input type="radio"/>
		E-mail Reception Port *4 *7	<input checked="" type="radio"/>
		E-mail Reception Interval	<input type="radio"/>
		Max. Reception E-mail Size	<input type="radio"/>
		E-mail Storage in Server	<input type="radio"/>
		Program/ Change/ Delete E-mail	<input type="radio"/>
		Program/ Change/ Delete Subject	<input type="radio"/>
		E-mail Account *3 *4	<input checked="" type="radio"/>

*1 Appears when the IEEE 1394 interface board (optional) is installed.

*2 Appears when the IEEE 802.11b (wireless LAN) board (optional) is installed.
If Ethernet and 802.11b (wireless LAN) are both connected to the machine, the selected interface has priority.

*3 Minimum settings required to use transmission.

*4 Minimum settings required to use reception.

*5 Check **[Effective]** is selected for TCP/IP.

*6 If you select **[ON]** for **[POP before SMTP]**, select this function also.

*7 If you select **[ON]** for **[POP before SMTP]**, check the port number for **[POP3]**.

*8 If you select **[ON]** for **[SMTP Authentication]**, select this function also.

E-mail

Interface	Settings		
Ethernet	Interface Settings/Network See p.34 "Interface Settings/Network".	IP Address	●
		Gateway Address	●
		DNS Configuration	○
		WINS Configuration	○
		LAN Type *2	●
		Ethernet Speed	○
		Effective Protocol *3	●
		Host Name	○
		Domain Name	○
	File Transfer See p.38 "File Transfer".	SMTP Server	●
		SMTP Authentication	○
		POP before SMTP	○
		POP3/ IMAP4 Settings *4	○
		Key Operator's E-mail Address	○
		E-mail Reception Port *5	○
		Program/ Change/ Delete E-mail	○
		Program/ Change/ Delete Subject	○
		Scanner Recall Interval Time	○
Number of Scanner Recalls	○		

Interface	Settings		
IEEE 1394 (IP over 1394)	Interface Settings/IEEE 1394 *1 See p.36 "Interface Settings/IEEE 1394".	IP Address	●
		IP over 1394	●
		WINS Configuration	○
		Host Name	○
		Domain Name	○
	Interface Settings/Network See p.34 "Interface Settings/Network".	Gateway Address	●
		DNS Configuration	○
		Effective Protocol *3	●
	File Transfer See p.38 "File Transfer".	SMTP Server	●
		SMTP Authentication	○
		POP before SMTP	○
		POP3/ IMAP4 Settings *4	○
		Key Operator's E-mail Address	○
		E-mail Reception Port *5	○
		Program/ Change/ Delete E-mail	○
Program/ Change/ Delete Subject		○	
Scanner Recall Interval Time		○	
Number of Scanner Recalls	○		

Interface	Settings		
IEEE 802.11b (wireless LAN)	Interface Settings/Network See p.34 "Interface Settings/Network".	IP Address	●
		Gateway Address	●
		DNS Configuration	○
		WINS Configuration	○
		LAN Type *2	●
		Ethernet Speed	○
		Effective Protocol *3	●
		Host Name	○
		Domain Name	○
Interface Settings/IEEE 802.11b *2 See p.37 "Interface Settings/IEEE 802.11b".	Interface Settings/IEEE 802.11b *2 See p.37 "Interface Settings/IEEE 802.11b".	Communication Mode	●
		SSID Setting	○
		Channel	○
		WEP (Encryption) Setting	○
		Transmission Speed	○
File Transfer See p.38 "File Transfer".	File Transfer See p.38 "File Transfer".	SMTP Server	●
		SMTP Authentication	○
		POP before SMTP	○
		POP3/ IMAP4 Settings *4	○
		Key Operator's E-mail Address	○
		E-mail Reception Port *5	○
		Program/ Change/ Delete E-mail	○
		Program/ Change/ Delete Subject	○
		Scanner Recall Interval Time	○
Number of Scanner Recalls	○		

*1 Appears when the IEEE 1394 interface board (optional) is installed.
 *2 Appears when the 802.11b (wireless LAN) board (optional) is installed. If Ethernet and 802.11b (wireless LAN) are both connected to the machine, the selected interface has priority.
 *3 Check **[Effective]** is selected for TCP/IP.
 *4 If you select **[ON]** for **[POP before SMTP]**, select this function as well.
 *5 If you select **[ON]** for **[POP before SMTP]**, check the port number for **[POP3]**.

Scan to Folder

Interface	Settings		
Ethernet	Interface Settings/Network See p.34 "Interface Settings/Network".	IP Address	<input checked="" type="radio"/>
		Gateway Address	<input checked="" type="radio"/>
		DNS Configuration	<input type="radio"/>
		WINS Configuration	<input type="radio"/>
		LAN Type *2	<input checked="" type="radio"/>
		Ethernet Speed	<input type="radio"/>
		Effective Protocol *3	<input checked="" type="radio"/>
		Host Name	<input type="radio"/>
		Domain Name	<input type="radio"/>
	IEEE 1394 (IP over 1394)	Interface Settings/IEEE 1394 *1 See p.36 "Interface Settings/IEEE 1394".	IP Address
IP over 1394			<input checked="" type="radio"/>
WINS Configuration			<input type="radio"/>
Host Name			<input type="radio"/>
Domain Name			<input type="radio"/>
Interface Settings/Network See p.34 "Interface Settings/Network".		Gateway Address	<input checked="" type="radio"/>
		DNS Configuration	<input type="radio"/>
		Effective Protocol *3	<input checked="" type="radio"/>
File Transfer See p.38 "File Transfer".		Default User Name/ Password (Send)	<input type="radio"/>
		Scanner Recall Interval Time	<input type="radio"/>
	Number of Scanner Recalls	<input type="radio"/>	

Interface	Settings		
IEEE 802.11b (wireless LAN)	Interface Settings/Network See p.34 "Interface Settings/Network".	IP Address	●
		Gateway Address	●
		DNS Configuration	○
		WINS Configuration	○
		LAN Type *2	●
		Ethernet Speed	○
		Effective Protocol *3	●
		Host Name	○
		Domain Name	○
	Interface Settings/IEEE 802.11b *2 See p.37 "Interface Settings/IEEE 802.11b".	Communication Mode	●
		SSID Setting	○
		Channel	○
		WEP (Encryption) Setting	○
		Transmission Speed	○
	File Transfer See p.38 "File Transfer".	Default User Name/ Password (Send)	○
Scanner Recall Interval Time		○	
Number of Scanner Recalls		○	

*1 Appears when the IEEE 1394 interface board (optional) is installed.

*2 Appears when the IEEE 802.11b (wireless LAN) board (optional) is installed. If Ethernet and IEEE 802.11b (wireless LAN) are both connected to the machine, the selected interface has priority.

*3 Check **[Effective]** is selected for TCP/IP.

Network Delivery Scanner

Interface	Settings		
Ethernet	Interface Settings/Network See p.34 "Interface Settings/Network".	IP Address	<input checked="" type="radio"/>
		Gateway Address	<input type="radio"/>
		DNS Configuration	<input type="radio"/>
		WINS Configuration	<input type="radio"/>
		LAN Type *2	<input checked="" type="radio"/>
		Ethernet Speed	<input type="radio"/>
		Effective Protocol *4	<input checked="" type="radio"/>
		Host Name	<input type="radio"/>
		Domain Name	<input type="radio"/>
	File Transfer See p.38 "File Transfer".	Delivery Option *3	<input type="radio"/>
		Fax RX File Transmission	<input type="radio"/>
Scanner Recall Interval Time		<input type="radio"/>	
Number of Scanner Recalls		<input type="radio"/>	
IEEE 1394 (IP over 1394)	Interface Settings/IEEE 1394 *1 See p.36 "Interface Settings/IEEE 1394".	IP Address	<input checked="" type="radio"/>
		IP over 1394	<input checked="" type="radio"/>
		WINS Configuration	<input type="radio"/>
		Host Name	<input type="radio"/>
		Domain Name	<input type="radio"/>
	Interface Settings/Network See p.34 "Interface Settings/Network".	Gateway Address	<input type="radio"/>
		DNS Configuration	<input type="radio"/>
		Effective Protocol *4	<input checked="" type="radio"/>
	File Transfer See p.38 "File Transfer".	Delivery Option *3	<input type="radio"/>
		Fax RX File Transmission	<input type="radio"/>
		Scanner Recall Interval Time	<input type="radio"/>
		Number of Scanner Recalls	<input type="radio"/>

Interface	Settings		
IEEE 802.11b (wireless LAN)	Interface Settings/Network See p.34 "Interface Settings/Network".	IP Address	●
		Gateway Address	○
		DNS Configuration	○
		WINS Configuration	○
		LAN Type *2	●
		Ethernet Speed	○
		Effective Protocol *4	●
		Host Name	○
		Domain Name	○
	Interface Settings/IEEE 802.11b *2 See p.37 "Interface Settings/IEEE 802.11b".	Communication Mode	●
		SSID Setting	○
		Channel	○
		WEP (Encryption) Setting	○
		Transmission Speed	○
	File Transfer See p.38 "File Transfer".	Delivery Option *3	○
		Fax RX File Transmission	○
Scanner Recall Interval Time		○	
Number of Scanner Recalls		○	

*1 Appears when the IEEE 1394 interface board (optional) is installed.

*2 Appears when the IEEE 802.11b (wireless LAN) board (optional) is installed.

If Ethernet and IEEE 802.11b (wireless LAN) are both connected to the machine, the selected interface has priority.

*3 When delivery option is set to **[ON]**, make sure the IP address is set.

*4 Check **[Effective]** is selected for TCP/IP.

Network TWAIN Scanner

Interface	Settings		
Ethernet	Interface Settings/Network See p.34 "Interface Settings/Network".	IP Address	<input checked="" type="radio"/>
		Gateway Address	<input type="radio"/>
		DNS Configuration	<input type="radio"/>
		WINS Configuration	<input type="radio"/>
		LAN Type ^{*2}	<input checked="" type="radio"/>
		Ethernet Speed	<input type="radio"/>
		Effective Protocol ^{*3}	<input checked="" type="radio"/>
		Host Name	<input type="radio"/>
		Domain Name	<input type="radio"/>
IEEE 1394 (IP over 1394)	Interface Settings/IEEE 1394 ^{*1} See p.36 "Interface Settings/IEEE 1394".	IP Address	<input checked="" type="radio"/>
		IP over 1394	<input checked="" type="radio"/>
		WINS Configuration	<input type="radio"/>
		Host Name	<input type="radio"/>
		Domain Name	<input type="radio"/>
	Interface Settings/Network See p.34 "Interface Settings/Network".	Gateway Address	<input type="radio"/>
		DNS Configuration	<input type="radio"/>
		Effective Protocol ^{*3}	<input checked="" type="radio"/>
IEEE 802.11b (wireless LAN)	Interface Settings/Network See p.34 "Interface Settings/Network".	IP Address	<input checked="" type="radio"/>
		Gateway Address	<input type="radio"/>
		DNS Configuration	<input type="radio"/>
		WINS Configuration	<input type="radio"/>
		LAN Type ^{*2}	<input checked="" type="radio"/>
		Ethernet Speed	<input type="radio"/>
		Effective Protocol ^{*3}	<input checked="" type="radio"/>
		Host Name	<input type="radio"/>
		Domain Name	<input type="radio"/>
	Interface Settings/IEEE 802.11b ^{*2} See p.37 "Interface Settings/IEEE 802.11b".	Communication Mode	<input checked="" type="radio"/>
		SSID Setting	<input type="radio"/>
		Channel	<input type="radio"/>
		WEP (Encryption) Setting	<input type="radio"/>
Transmission Speed		<input type="radio"/>	

^{*1} Appears when the IEEE 1394 interface board (optional) is installed.

^{*2} Appears when the IEEE 802.11b (wireless LAN) board (optional) is installed.

If Ethernet and 802.11b (wireless LAN) are both connected to the machine, the selected interface has priority.

^{*3} Check **[Effective]** is selected for TCP/IP.

Document Server

Interface	Settings		
Ethernet	Interface Settings/Network See p.34 "Interface Settings/Network".	IP Address	<input checked="" type="radio"/>
		Gateway Address	<input type="radio"/>
		DNS Configuration	<input type="radio"/>
		WINS Configuration	<input type="radio"/>
		LAN Type ^{*2}	<input checked="" type="radio"/>
		Ethernet Speed	<input type="radio"/>
		Effective Protocol ^{*3}	<input checked="" type="radio"/>
		Host Name	<input type="radio"/>
		Domain Name	<input type="radio"/>
IEEE 1394 (IP over 1394)	Interface Settings/IEEE 1394 ^{*1} See p.36 "Interface Settings/IEEE 1394".	IP Address	<input checked="" type="radio"/>
		IP over 1394	<input checked="" type="radio"/>
		WINS Configuration	<input type="radio"/>
		Host Name	<input type="radio"/>
		Domain Name	<input type="radio"/>
	Interface Settings/Network See p.34 "Interface Settings/Network".	Gateway Address	<input type="radio"/>
		DNS Configuration	<input type="radio"/>
		Effective Protocol ^{*3}	<input checked="" type="radio"/>
IEEE 802.11b (wireless LAN)	Interface Settings/Network See p.34 "Interface Settings/Network".	IP Address	<input checked="" type="radio"/>
		Gateway Address	<input type="radio"/>
		DNS Configuration	<input type="radio"/>
		WINS Configuration	<input type="radio"/>
		LAN Type ^{*2}	<input checked="" type="radio"/>
		Ethernet Speed	<input type="radio"/>
		Effective Protocol ^{*3}	<input checked="" type="radio"/>
		Host Name	<input type="radio"/>
		Domain Name	<input type="radio"/>
	Interface Settings/IEEE 802.11b ^{*2} See p.37 "Interface Settings/IEEE 802.11b".	Communication Mode	<input checked="" type="radio"/>
		SSID Setting	<input type="radio"/>
		Channel	<input type="radio"/>
		WEP (Encryption) Setting	<input type="radio"/>
		Transmission Speed	<input type="radio"/>

^{*1} Appears when the IEEE 1394 interface board (optional) is installed.

^{*2} Appears when the IEEE 802.11b (wireless LAN) board (optional) is installed.

If Ethernet and IEEE 802.11b (wireless LAN) are both connected to the machine, the selected interface has priority.

^{*3} Check **[Effective]** is selected for TCP/IP.

Network Configuration

Any change you make with User Tools remains in effect even if the main power switch or operation switch is turned off, or the **[Energy Saver]** or **[Clear Modes]** key is pressed.

Configuring the network using the control panel

Note

- Operations for System Settings are different from normal operations. After using User Tools, press the **[User Tools/Counter]** key to exit.
- If **[Key Operator Code]** has been set, the key operator code entry screen appears. Enter the code, and then press **[OK]**. See *General Settings Guide*.

- 1** Press the **[User Tools/Counter]** key.



Note

- The machine will be offline during setting.

- 2** Press **[System Settings]**.
- 3** Press **[Interface Settings]** or **[File Transfer]**.
- 4** Select the required menu, and then press the desired key.

- 5** Change settings by following the instructions on the display panel, and then press **[OK]**.

Note

- To cancel changes made to settings and return to the System Settings menu, press **[Cancel]**.

- 6** Press **[Exit]**.

- 7** Press the **[User Tools/Counter]** key.

Note

- You can also exit by pressing **[Exit]** on the User Tools main menu.

Configuring the network using other utilities

As well as using the control panel to make network settings, utilities such as a Web browser and SmartNetMonitor for Admin can also be used. The following table shows available settings:

 **Note**

- Indicates machine settings can be changed.
- Indicates the setting cannot be changed from that device.

Name on the control panel				Web browser	Smart-NetMonitor for Admin	telnet		
Interface Settings	Network	IP Address	Auto-Obtain (DHCP)		○	○	○	
			Specify	IP Address	○	○	○	
				Sub-net Mask	○	○	○	
		Gateway Address				○	○	○
		DNS Configuration	Auto-Obtain (DHCP)		○	-	○	
			Specify	DNS Server 1	○	-	○	
				DNS Server 2	○	-	○	
				DNS Server 3	○	-	○	
		WINS Configuration	WINS Server		○	-	○	
			Scope ID		○	-	○	
		NW Frame Type	Auto Select		○	-	○	
			Ethernet II		○	-	○	
			Ethernet 802.2		○	-	○	
			Ethernet 802.3		○	-	○	
			Ethernet SNAP		○	-	○	
		LAN Type	Ethernet		○	-	○	
			IEEE 802.11b		○	-	○	
		Ethernet Speed				-	-	-

3

Name on the control panel				Web browser	Smart-NetMonitor for Admin	telnet		
Interface Settings	Network	Effective Protocol	TCP/IP		-	<input type="radio"/> *1	<input type="radio"/>	
			NetWare		<input type="radio"/>	<input type="radio"/> *2	<input type="radio"/>	
			SMB		<input type="radio"/>	<input type="radio"/>	<input type="radio"/>	
			AppleTalk		<input type="radio"/>	<input type="radio"/>	<input type="radio"/>	
			SNMP		<input type="radio"/>	<input type="radio"/>	<input type="radio"/>	
		Host Name		<input type="radio"/>	<input type="radio"/>	<input type="radio"/>		
		Domain Name		<input type="radio"/>	-	<input type="radio"/>		
	IEEE 1394	IP Address	Auto-Obtain (DHCP)		<input type="radio"/>	-	<input type="radio"/>	
			Specify	IP Address		<input type="radio"/>	-	<input type="radio"/>
				Sub-net Mask		<input type="radio"/>	-	<input type="radio"/>
		IP over 1394		<input type="radio"/>	-	<input type="radio"/>		
		WINS Configuration	WINS Server		<input type="radio"/>	-	<input type="radio"/>	
			Scope ID		<input type="radio"/>	-	<input type="radio"/>	
		SCSI print (SBP-2)		<input type="radio"/>	-	<input type="radio"/>		
		Bidirectional SCSI print		<input type="radio"/>	-	<input type="radio"/>		
		Host Name		<input type="radio"/>	-	<input type="radio"/>		
		Domain Name		<input type="radio"/>	-	<input type="radio"/>		
		IEEE 802.11b	Communication Mode		<input type="radio"/>	-	<input type="radio"/>	
			SSID Setting		<input type="radio"/>	-	<input type="radio"/>	
			Channel		<input type="radio"/>	-	<input type="radio"/>	
WEP (Encryption) Setting			<input type="radio"/>	-	<input type="radio"/>			
Transmission Speed			-	-	<input type="radio"/>			
File Transfer	SMTP Server			<input type="radio"/>	-	-		
	SMTP Authentication			<input type="radio"/>	-	-		
	POP before SMTP			<input type="radio"/>	-	-		
	Reception Protocol			<input type="radio"/>	-	-		
	POP3/ IMAP4 Settings			<input type="radio"/>	-	-		
	Key Operator's E-mail Address			<input type="radio"/>	-	-		
	E-mail Reception Port			<input type="radio"/>	-	-		
	E-mail Reception Interval			<input type="radio"/>	-	-		

Name on the control panel		Web browser	Smart-NetMonitor for Admin	telnet
File Transfer	Max. Reception E-mail Size	○	-	-
	E-mail Storage in Server	○	-	-
	Default User Name/ Password (Send)	○	-	-
	Program/ Change/ Delete E-mail Message	-	-	-
	Program/ Change/ Delete Subject	-	-	-
	Scanner Recall Interval Time	-	-	-
	Number of Scanner Recalls	-	-	-
	E-mail Account	-	-	-

*1 You can make the TCP/IP settings if SmartNetMonitor for Admin is communicating with the machine using IPX/SPX.

*2 You can make the IPX/SPX settings if SmartNetMonitor for Admin is communicating with the machine using TCP/IP.

Settings You Can Change with User Tools

Interface Settings/Network

◆ IP Address

Before using this machine in the network environment, you must configure the IP address and sub-net mask.

- Auto-Obtain (DHCP)
- Specify
When you select **[Specify]**, enter the **[IP Address]** and **[Sub-net Mask]** as "xxx.xxx.xxx.xxx" ("x" indicates a number).
 - IP Address: 011.022.033.044
 - Sub-net Mask: 000.000.000.000

Note

- Default: *Auto-Obtain (DHCP)*
- If you use the interface for Ethernet and IEEE 1394 (IP over 1394) at the same time, settings must be made with care.
- If you install the IEEE 1394 interface board (optional) and use the IEEE 1394 interface, you must set the address of the domain, different from the **[IP Address]** of **[IEEE 1394]**. If you intend to set the address for the same domain, set a different value for the **[Sub-net Mask]**.
- When you select **[Specify]**, be sure not to set the same **[IP Address]** as that of another machines on the network.
- The physical address (MAC address) also appears.

❖ Gateway Address

A gateway is a connection or interchange point between two networks. Configure the gateway address for the router or host computer used as a gateway.

- Gateway Address:000.000.000.000

Note

- Default: 000.000.000.000

❖ DNS Configuration

Make settings for the DNS server.

- Auto-Obtain (DHCP)
- Specify
When you select **[Specify]**, enter the **[DNS Server]** IP address as "xxx.xxx.xxx.xxx" ("x" indicates a number).
 - DNS Server 1:000.000.000.000
 - DNS Server 2:000.000.000.000
 - DNS Server 3:000.000.000.000

Note

- Default: *Auto-Obtain (DHCP)*

❖ WINS Configuration

You can specify the WINS server settings.

- ON
If **[ON]** is selected, enter the **[WINS Server]** IP address as "xxx.xxx.xxx.xxx" ("x" indicates a number).
If DHCP is in use, specify the **[Scope ID]**.
 - WINS Server:000.000.000.000
 - Scope ID
- OFF

Limitation

- Enter a **[Scope ID]** using up to 31 alphanumeric characters.

Note

- Default: *OFF*

❖ NW Frame Type

Select the frame type when you use NetWare.

- Auto Select
- Ethernet II
- Ethernet 802.2
- Ethernet 802.3
- Ethernet SNAP

Note

- Default: *Auto Select*

❖ LAN Type

When you have installed the IEEE 802.11b (wireless LAN) board (optional), select interface, IEEE 802.11b (wireless LAN) or Ethernet.

- Ethernet
- IEEE 802.11b

Note

- Default: *Ethernet*
- Appears when the IEEE 802.11b (wireless LAN) board is installed.
- If Ethernet and IEEE 802.11b (wireless LAN) are both connected to the machine, the selected interface takes precedence.

❖ Ethernet Speed

Set the access speed for networks. Select a speed that matches your network environment. **[Auto Select]** should usually be selected.

- Auto Select
- 100Mbps Fixed
- 10Mbps Fixed

Note

- Default: *Auto Select*

❖ **Effective Protocol**

Select the protocol to use in the network.

- TCP/IP:Effective/Invalid
- NetWare:Effective/Invalid
- SMB:Effective/Invalid
- AppleTalk:Effective/Invalid

 **Note**

- Default: *TCP/IP:Effective, NetWare:Effective, SMB:Effective, AppleTalk:Effective*

❖ **Host Name**

Specify the host name.

❖ **Domain Name**

Specify the domain name.

Interface Settings/IEEE 1394

 **Preparation**

You must install the IEEE 1394 interface board (optional) in the machine.

❖ **IP Address**

When you connect the machine to a network using the IEEE 1394 interface, you must configure the IP address and subnet mask.

- Auto-Obtain (DHCP)
- Specify
When you select **[Specify]**, enter the **[IP Address]** and **[Sub-net Mask]** as "xxx.xxx.xxx.xxx" ("x" indicates a number).
 - IP Address: 011.022.033.044
 - Sub-net Mask: 000.000.000.000

 **Note**

- Default: *Auto-Obtain (DHCP)*
- If you use the interface for Ethernet and IEEE 1394 (IP over 1394) at the same time, settings must be made carefully. See p.104 "Using DHCP"
- When you use the IEEE 1394 interface on a network, you cannot use the Ethernet interface in the same domain. To use both interfaces in the same domain, set different values for the **[Sub-net Mask]**.
- The physical address (MAC address) also appears.

❖ **IP over 1394**

When you use the IP over 1394 function of the IEEE 1394 interface to connect the machine to the network, or you print from computer with the IP over 1394 driver, you must specify **[Active]**for **[IP over 1394]**.

- Active
- Inactive

 **Note**

- Default: *Active*

❖ **WINS Configuration**

You can specify the WINS server settings.

- ON
If **[ON]** is selected, specify the **[WINS Server]** IP address as "xxx.xxx.xxx.xxx" ("xxx" indicates a number).
If DHCP is in use, specify the **[Scope ID]**.
 - WINS Server:000.000.000.000
 - Scope ID
- OFF

Limitation

- Enter [**Scope ID**] using up to 31 alphanumeric characters.

Note

- Default: *OFF*

❖ **SCSI print (SBP-2)**

When you print using the SCSI print client function supported by Windows 2000 or Windows XP, you must set SCSI print.

- Active
- Inactive

Note

- Default: *Active*

❖ **Bidirectional SCSI print**

Specifies the printer's response mode etc. for status requests when using the IEEE 1394 interface.

- ON
- OFF

Note

- Default: *ON*
- If this is set to [**OFF**], bidirectional communication will not work.

❖ **Host Name**

Specify the host name.

❖ **Domain Name**

Specify the domain name.

Interface Settings/IEEE 802.11b

Preparation

You must install the IEEE 802.11b (wireless LAN) board (optional) into the machine.

Note

- Be sure to make all settings simultaneously.

❖ **Communication Mode**

Specifies the communication mode of the wireless LAN.

- 802.11 Ad hoc
- Ad hoc
- Infrastructure

Note

- Default: *802.11 Ad hoc*

❖ **SSID Setting**

Specifies SSID to distinguish the access point in infrastructure mode or 802.11 ad hoc mode.

Limitation

- The characters that can be used are ASCII 0x20-0x7e (32 bytes).

Note

- Default: *blank (ASSID)*
- If blank is specified in 802.11b ad hoc mode or ad hoc mode, "ASSID" appears.

❖ **Channel**

Specifies a channel when you select 802.11b ad hoc mode or ad hoc mode.

Note

- Default: *11*
- The following channels are available:
 - Metric version: 1-13
 - Inch version: 1-11

❖ **WEP (Encryption) Setting**

Specifies the encryption of the IEEE 802.11b (wireless LAN). If this is set to **[Active]**, you must enter the WEP key.

- WEP
 - Active
 - Inactive
- Encryption

 **Note**

Default: *Inactive*

❖ **Wireless LAN Signal**

Shows the radio wave conditions of the access point connected in infrastructure mode.

 **Note**

Radio wave status is displayed when you press **[Wireless LAN Signal]**.

❖ **Transmission Speed**

Specifies the communication speed of the IEEE 802.11b (wireless LAN).

- Auto
- 11Mbps Fixed
- 5.5Mbps Fixed
- 2Mbps Fixed
- 1Mbps Fixed

 **Note**

Default: *Auto*

❖ **Return to Defaults**

You can return the IEEE 802.11b (wireless LAN) settings to their defaults.

- No
- Yes

Interface Settings/Print List

You can check items related to the network in use.

 **Reference**

For details about printing, see p.44 “Printing the Interface Settings”.

File Transfer

❖ **Delivery Option**

Enables or disables sending stored or scanned documents via the ScanRouter V2 Professional/Lite delivery server.

- ON
 - Main Delivery Sever
 - Sub Delivery Sever
- OFF

 **Note**

Default: *OFF*

Set this option when specifying whether or not to use ScanRouter V2 Professional/Lite. If you do, you will have to re-register I/O devices in ScanRouter V2 Professional/Lite.

❖ **Fax RX File Transmission**

• **Setting per Line**
 Specifies whether or not received fax documents are sent to ScanRouter V2 Professional for each fax line.

- Line 1:Deliver to Server/Do not Deliver
- Line 2:Deliver to Server/Do not Deliver
- Line 3:Deliver to Server/Do not Deliver
- E-mail:Deliver to Server/Do not Deliver

 **Note**

Default: *Do not Deliver*

- **Print at Delivery**
Specifies whether or not received fax documents sent to ScanRouter V2 Professional should also be printed at the same time.
 - Print
 - Do not Print

 **Note**

Default: *Do not Print*

- **File to Deliver**
Specifies whether all received fax documents or only received fax documents that include delivery codes (documents with an ID and SUB/SEP code) are sent to ScanRouter V2 Professional.
 - File with Dlvry Code
 - All Files

 **Note**

Default: *All Files*

- **Dlvry Failure File**
 - Print File
 - Delete File

If a received fax document cannot be sent to ScanRouter V2 Professional, it is stored in memory. To print a stored file, select **[Print File]**; to delete, select **[Delete File]**.

 **Note**

- If the machine can send the data to ScanRouter V2 Professional, it does so automatically.
- If you delete the data, you will not be able to distribute or print it.

 **SMTP Server**

Specify the SMTP server name.

If DNS is in use, enter the host name.

If DNS is not in use, enter the SMTP server IP address.

- Server Name
- Port No.:25

 **Limitation**

- Enter the **[Server Name]** using up to 127 alphanumeric characters. Space can not be used.

 **Note**

- Enter **[Port No.]** between 1 and 65535 using the number keys, and then press the **[#]**key.

 **SMTP Authentication**

You can configure SMTP authentication (PLAIN, LOGIN, CRAM-MD5).

Authentication prevents unauthorized access, by making users enter a user name and password when sending e-mail to the SMTP server.

SMTP Authentication

- **ON**
If the SMTP server requires authentication, set **[SMTP Authentication]** to **[ON]**, and then specify **[User Name]**, **[Password]**, and **[Encryption]**.
 - User Name
 - Password
 - Encryption
Auto/ON/OFF
- **OFF**

 **Limitation**

- Enter **[User Name]** using up to 191 alphanumeric characters. Space can not be used.

- Depending on the SMTP server type, "realm" must be specified. Add "@" after the user name, as in "user name@realm".
- Enter **[Password]** using up to 63 alphanumeric characters. Space can not be used.
- Enter the user name and password to be set for **[Key Operator's E-mail Address]** when sending Internet faxes.

 **Note**

- Default: *OFF*
- [Encryption]-[Auto]**: If the authentication method is PLAIN, LOGIN, or, CRAM-MD5.
- [Encryption]-[ON]**: If the authentication method is CRAM-MD5.
- [Encryption]-[OFF]**: If the authentication method is PLAIN, or LOGIN.

❖ **POP before SMTP**

You can configure POP authentication (POP before SMTP). Authentication prevents unauthorized access, by authenticating with the POP server before sending e-mail to the SMTP server.

- ON
To enable POP server authentication before sending e-mail via the SMTP server, set **[POP before SMTP]** to **[ON]**. E-mail is sent to the SMTP server after the time specified for **[Wait Time after Auth.]** has elapsed.
 - Wait Time after Auth.: 300msec
 - User Name
 - Password
- OFF

 **Limitation**

- Enter **[User Name]** using up to 63 alphanumeric characters. Space can not be used.
- Enter **[Password]** using up to 63 alphanumeric characters. Space can not be used.

 **Note**

- Default: *OFF*
- Using the number keys, you can set **[Wait Time after Auth.]** from zero to 10,000 milliseconds, in increments of one millisecond.
- If you select **[ON]**, enter **[Server Name]** in **[POP3/ IMAP4 Settings]**. Also, check the port number for **[POP3]** in **[E-mail Reception Port]**.

❖ **Reception Protocol**

Specify Reception Protocol for receiving Internet faxes.

- OFF
- POP3
- IMAP4
- SMTP

 **Note**

- Default: *OFF*

❖ **POP3/ IMAP4 Settings**

Specify the POP3/IMAP4 **[Server Name]** for receiving Internet faxes. The specified POP3 server name is used for **[POP before SMTP]**.

If DNS is in use, enter the host name.

If DNS is not in use, enter the POP3 or IMAP4 server IP address.

- Server Name
- Encryption
 - Auto
 - ON
 - OFF

! Limitation

- Enter POP3 or IMAP4 **[Server Name]** using to 127 alphanumeric characters. Space can not be used.

✎ Note

- [Encryption]-[Auto]**: Password encryption is automatically set according to the POP server settings.
- [Encryption]-[ON]**: Encrypt password.
- [Encryption]-[OFF]**: Do not encrypt password.

❖ Key Operator's E-mail Address

On e-mailed scanned documents, if the sender is not specified this appears as the sender's address. This can be used as the sender with SMTP authentication for Internet Fax. If **[ON]** is selected for **[SMTP Authentication]**, be sure to enter the key operator's e-mail address here. This can be used as the destination for data transmission result, as well as the destination for data communication management e-mail.

! Limitation

- Enter up to 128 alphanumeric characters.

✎ Note

- Specify the sender's name when sending scanned document e-mail, if **[No]** is selected in **[Sender's Name Default]**.

❖ E-mail Reception Port

Specify the **[POP3]**, **[IMAP4]**, and **[SMTP]** port numbers for receiving Internet faxes.

The specified POP3 port number is used for **[POP before SMTP]**.

- POP3: 110
- IMAP4: 143
- SMTP: 25

✎ Note

- Default: *POP3/110, IMAP4/143, SMTP/25*
- Enter a port number between 1 and 65535 using the number keys, and then press the **[#]** key.

❖ E-mail Reception Interval

Specify, in minutes, the time limit for receiving Internet faxes via POP3 or IMAP4 server.

- ON: 15 minute(s)
- OFF

✎ Note

- Default: *ON/15 minute(s)*
- If **[ON]** is selected, the number of times can be set from 2 to 1440 in increments of one minute, using the number keys.

❖ Max. Reception E-mail Size

Specify the max. reception e-mail size for receiving Internet faxes.

✎ Note

- Default: *2MB*
- Using the number keys, enter a size from one to 50 MB in increments of one megabyte.

❖ E-mail Storage in Server

You can specify whether or not to store received Internet fax e-mails on the POP3 or IMAP4 server.

- OFF
- All
- Errors Only

✎ Note

- Default: *OFF*

❖ **Default User Name/ Password (Send)**

You can specify the user name and password required when sending scan file directly to a shared folder on a computer running Windows, or to an FTP server.

- SMB User Name
- SMB Password
- FTP User Name
- FTP Password

📌 **Limitation**

- Enter up to 128 alphanumeric characters.

❖ **Program/ Change/ Delete E-mail Message**

You can program, change, or delete the e-mail message used when sending an Internet fax or scan file as an attachment.

- Program/ Change
- Delete

📌 **Note**

- Enter a name using up to 20 alphanumeric characters.
- Enter up to five lines of text. Each line can consist of up to 80 alphanumeric characters.

❖ **Program/ Change/ Delete Subject**

You can program, change, or delete the subject used when sending an Internet fax or scan file as an attachment.

- Program/ Change
- Delete

📌 **Note**

- Enter a subject using up to 20 alphanumeric characters.

❖ **Scanner Recall Interval Time**

Specifies the interval the machine waits before resending scan file, if they cannot be sent to the delivery server or mail server.

📌 **Note**

- Default: *300 seconds*
- The interval time can be set from 60 to 999 seconds in one second increments, using the number keys.
- This setting is for the scanner function.

❖ **Number of Scanner Recalls**

Sets a maximum number of times scan file is resent to the delivery server or mail server.

- ON: 3 time(s)
- OFF

📌 **Note**

- Default: *ON/3 time(s)*
- If [ON] is selected, the number of times can be set from 1 to 99 using the number keys.
- This setting is for the scanner function.

❖ **E-mail Account**

Specify [E-mail Address], [User Name], and [Password] for receiving Internet faxes.

- Fax Mail Reception
 - E-mail Address
 - User Name
 - Password

📌 **Limitation**

- Enter an e-mail address using up to 128 alphanumeric characters.
- Enter a user name using up to 64 alphanumeric characters.
- Enter a password using up to 64 alphanumeric characters.

Programming, changing, or deleting an e-mail message

Limitation

- Enter a name using up to 20 alphanumeric characters.
- Enter up to five lines of text. Each line can consist of up to 80 alphanumeric characters.

- 1** Press the **[User Tools/Counter]** key.
- 2** Press **[System Settings]**.
- 3** Press **[File Transfer]**.
- 4** Press **[▼Next]**.

The next screen appears.

- 5** Press **[Program/ Change/ Delete E-mail Message]**.

Programming an e-mail message

- 1** Press **[*Not programed]**.
- 2** Press **[Change]**, and then enter the name.

Reference

For more information about entering text, see “Entering Text”, *General Settings Guide*.

- 3** Press **[OK]**.
- 4** Press **[Edit]**, and then enter the text.

To start a new line, press **[OK]** to return to the e-mail message screen, and then press **[▼]** in **[Select Line to Edit:]**.

- 5** Press **[OK]**.

The e-mail message screen appears.

- 6** Press **[OK]**.

Changing an e-mail message

- 1** Select the e-mail message to change.
- 2** If you want to change the subject, press **[Change]**.
- 3** Change the subject, and then press **[OK]**.
- 4** If you want to change the text, press **[Edit]**.
- 5** Press **[▲]** or **[▼]** to select the line to change.
- 6** Change the text, and then press **[OK]**.
- 7** Press **[OK]**.

Deleting an e-mail message

- 1** Press **[Delete]**.
 - 2** Select the e-mail message to delete.
- The confirmation message about deleting appears.
- 3** To delete the data, press **[Yes]**.

- 6** Press **[Exit]**.

- 7** Press **[Exit]**.

- 8** Press the **[User Tools/Counter]** key.

Note

- You can also exit by pressing **[Exit]** on the User Tools main menu.

Programming, changing, or deleting a subject

 **Limitation**

- Enter a subject using up to 20 alphanumeric characters.

 **Note**

- [Urgent]** and **[High]** are programmed as the e-mail subjects.

- 1** Press the **[User Tools/Counter]** key.
- 2** Press **[System Settings]**.
- 3** Press **[File Transfer]**.
- 4** Press **[▼Next]**. The next screen appears.
- 5** Press **[Program/ Change/ Delete Subject]**.

Programming a subject

- 1** Press **[*Not programed]**, and then enter the text.

 **Reference**

For more information about entering text, see “Entering Text”, *General Settings Guide*.

- 2** Press **[OK]**.

Changing a subject

- 1** Select the subject to change.
- 2** Enter the text.
- 3** Press **[OK]**.

Deleting a subject

- 1** Press **[Delete]**.
- 2** Select the subject to delete.
The confirmation message about deleting appears.
- 3** To delete the subject, press **[Yes]**.

- 6** Press **[Exit]**.

- 7** Press **[Exit]**.

- 8** Press the **[User Tools/Counter]** key.
You can also exit by pressing **[Exit]** on the User Tools main menu.

Printing the Interface Settings

The configuration page shows the current network settings and network information.

- 1** Press the **[User Tools/Counter]** key.
- 2** Press **[System Settings]**.
- 3** Press **[Interface Settings]**.
- 4** Press **[Print List]**.
- 5** Press the **[Start]** key.

The configuration page is printed.

- 6** Press **[Exit]**.

- 7** Press the **[User Tools/Counter]** key.

 **Note**

- You can also exit by pressing **[Exit]** on the User Tools main menu.

4. Windows Configuration

Configuring TCP/IP

This describes how to configure Windows for TCP/IP and IPP.

Configuring a Windows 95/98/Me Computer

Follow the procedure below to configure a Windows 95/98/Me computer to use TCP/IP.

- 1** Open [Control Panel], and then double-click the Network icon. Make sure [TCP/IP] is listed in the [The following network components are installed] box on the [Configuration] tab.

 **Note**

- Under Windows Me, if you want to use IEEE 1394 (IP over 1394) interface, make sure TCP/IP is bound to the IEEE 1394 adaptor being used. The following message appears:

TCP/ IP -> (IEEE 1394 adaptor in use)

- If TCP/IP is not installed, click [Add] on the [Configuration] tab to install it. For more information about installing TCP/IP, see Windows 95/98/Me Help.

- 2** Configure TCP/IP using the appropriate IP address, subnet mask, and other settings.

Check with the network administrator that the settings are correct.

Configuring a Windows 2000 Computer

Follow the procedure below to configure a Windows 2000 computer to use TCP/IP.

- 1** On the [Start] menu, point to [Settings], and then click [Network and Dial-up Connections].

- 2** Double-click [Local Area Connection]. On the [General] tab, click [Properties].

- 3** Make sure [Internet Protocol (TCP/IP)] is selected in the [Components checked are used by this connection] box on the [General] tab.

 **Note**

- Select TCP/IP if it is not already selected.
- If TCP/IP is not installed, click [Install] on the [General] tab to install it. For more information about installing TCP/IP, see Windows 2000 Help.

- 4** Configure TCP/IP using the appropriate IP address, subnet mask, and other settings.

Check with the network administrator that the settings are correct.

Configuring a Windows XP Computer

Follow the procedure below to configure a Windows XP computer to use TCP/IP.

1 On the [Start] menu, click [Control Panel], and then click [Network and Internet Connections].

2 Click [Network Connections], and then double-click [Local Area Connection].

3 On the [General] tab, click [Properties].

 **Note**

If you want to use IEEE 1394 (IP over 1394) interface, click [1394 Connection].

4 Make sure [Internet Protocol (TCP/IP)] is selected in the [This connection uses the following items] box on the [General] tab.

 **Note**

Select TCP/IP if it is not already selected.

If TCP/IP is not installed, click [Install] on the [General] tab to install it. For more information about installing TCP/IP, see Windows XP Help.

5 Configure TCP/IP using the appropriate IP address, subnet mask, and other settings.

Check with the network administrator that the settings are correct.

Configuring a Windows NT 4.0 Computer

Follow the procedure below to configure a Windows NT 4.0 computer to use TCP/IP.

1 Open [Control Panel], and then double-click the Network icon. Make sure [TCP/IP Protocol] is listed in the [Network protocols] box on the [Protocols] tab.

 **Note**

If TCP/IP is not installed, click [Add] on the [Protocols] tab to install it. For more information about installing TCP/IP, see Windows NT 4.0 Help.

2 Configure TCP/IP using the appropriate IP address, subnet mask, and other settings.

Check with the network administrator that the settings are correct.

Configuring NetBEUI

This describes how to configure Windows to use NetBEUI.

Limitation

- NetBEUI cannot be used under Windows XP.

Note

- NetBEUI appears as SMB in the control panel, manual, and related utilities.

Configuring a Windows 95/98/Me Computer

Follow the procedure below to configure a Windows 95/98/Me computer to use NetBEUI.

- 1** Open **[Control Panel]**, and then double-click the **Network** icon. Make sure **[NetBEUI]** is listed in the **[The following network components are installed]** box on the **[Configuration]** tab.

Note

- If NetBEUI is not installed, click **[Add]** on the **[Configuration]** tab to install it. For more information about installing NetBEUI, see Windows 95/98/Me Help.
- If **[NetBEUI →Dial-Up Adaptor]** is listed in the **[The following network components are installed]** box, select it, and then click **[Remove]** to remove the binding.

- 2** Click **[OK]** to close the **[Network] dialog box**.

Configuring a Windows 2000 Computer

Follow the procedure below to configure a Windows 2000 computer to use NetBEUI.

- 1** On the **[Start]** menu, point to **[Settings]**, and then click **[Network and Dial-up Connections]**.
- 2** Double-click **[Local Area Connection]**. On the **[General]** tab, click **[Properties]**.
- 3** Make sure **[NetBEUI Protocol]** is selected in the **[Components checked are used by this connection]** box on the **[General]** tab.

Note

- Select NetBEUI if it is not already selected.
- If NetBEUI is not installed, click **[Install]** on the **[General]** tab to install it. For more information about installing NetBEUI, see Windows 2000 Help.

Configuring a Windows NT Computer

Follow the procedure below to configure a Windows NT computer to use NetBEUI.

1 Open [Control Panel], and then double-click the Network icon. Make sure [NetBEUI Protocol] is listed in the [Network protocols] box on the [Protocols] tab.

 **Note**

- If NetBEUI is not installed, click [Add] on the [Protocols] tab to install it. For more information about installing NetBEUI, see Windows NT Help.

2 Change the Lana Number. Click the [Services] tab, click [NetBIOS Interface] in the [Network services] box, and then click [Properties].

3 Click the Lana Number corresponding to the Nbf protocol in the [Network Route] column, and then click [Edit].

4 Enter "0" as the Lana Number.

 **Note**

- If the other protocol's Lana Number is "0", you must change the Lana Number to a number other than "0".

5 Click [OK].

6 Click [Close] to close the [Network] dialog box.

The confirmation message about restarting appears.

7 Click [Yes].

 **Note**

- After you change the Lana Number, you must restart the computer.

5. Using the Printer Function

This section contains instructions for configuring the machine as a network printer. Read the section that relates to your network environment for information about correct configuration.

❖ Printing with a Windows 2000/XP or Windows NT Print Server

To set up the machine as a network printer in Windows 95/98/Me, Windows 2000/XP, and Windows NT 4.0 environment, see p.52 “Printing with Windows”.

- Printing with a Windows 2000/XP or Windows NT print server

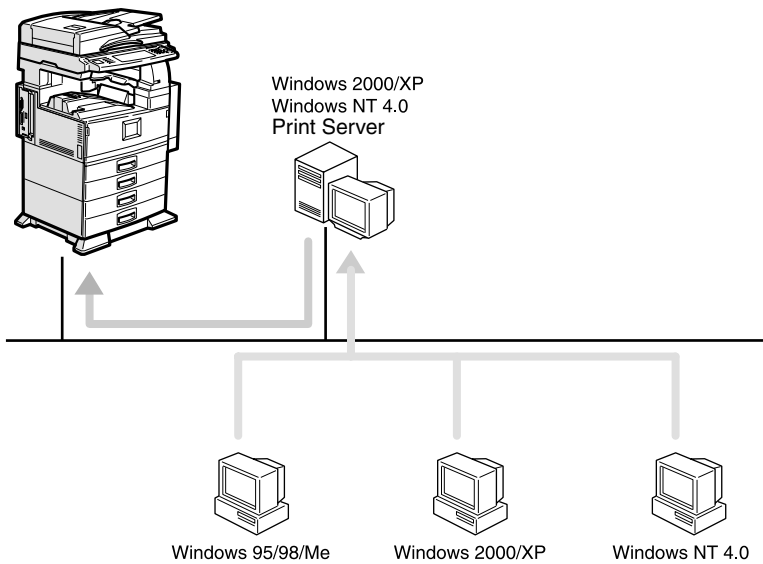

- Printing without a print server

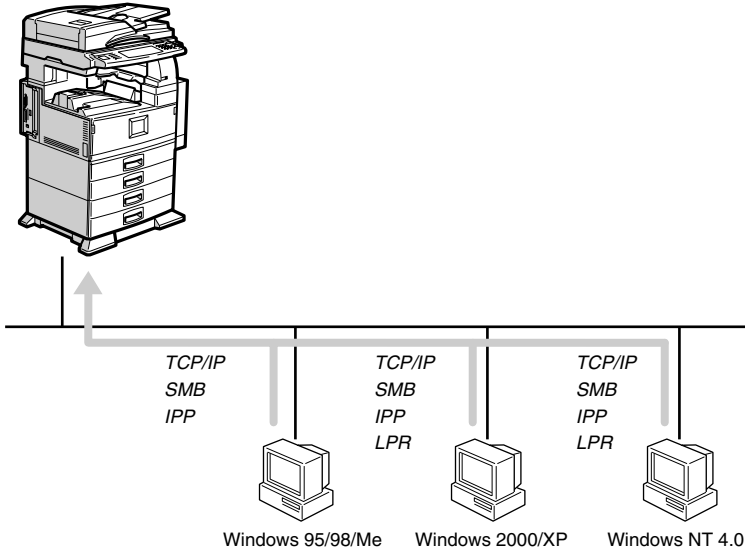

5

Note

- Under Windows XP, you cannot print via SmartNetMonitor for Client using SMB.

❖ **Printing with a Macintosh**

To set up the machine as a network printer in a Macintosh environment, see p.56 “Printing with a Macintosh”.

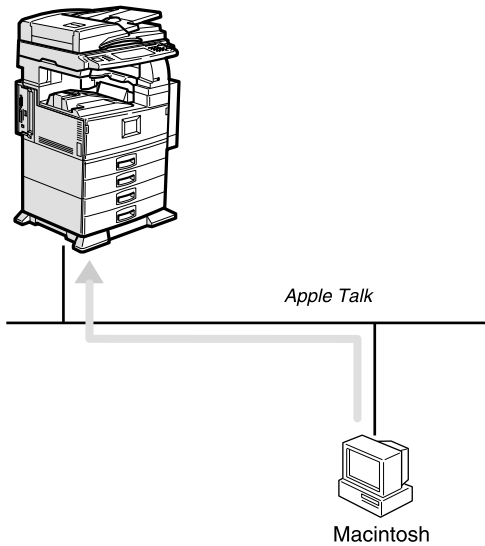

❖ Printing with NetWare

To set up the machine as a print server or remote printer in a NetWare environment, see p.58 "Printing with NetWare". The network interface board allows you to use the machine as either a print server or a remote printer.

- Configuring the machine as a print server

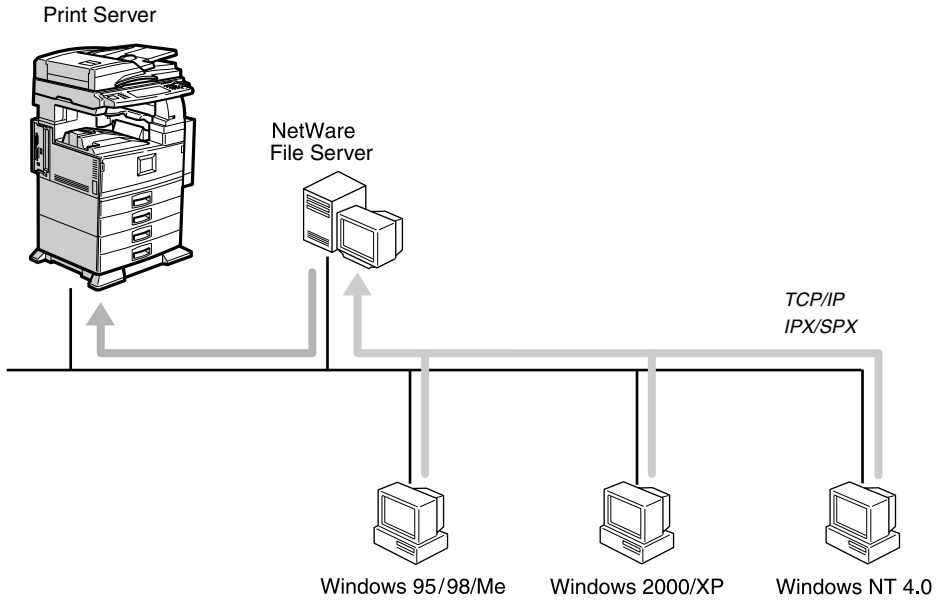

- Configuring the machine as a remote printer

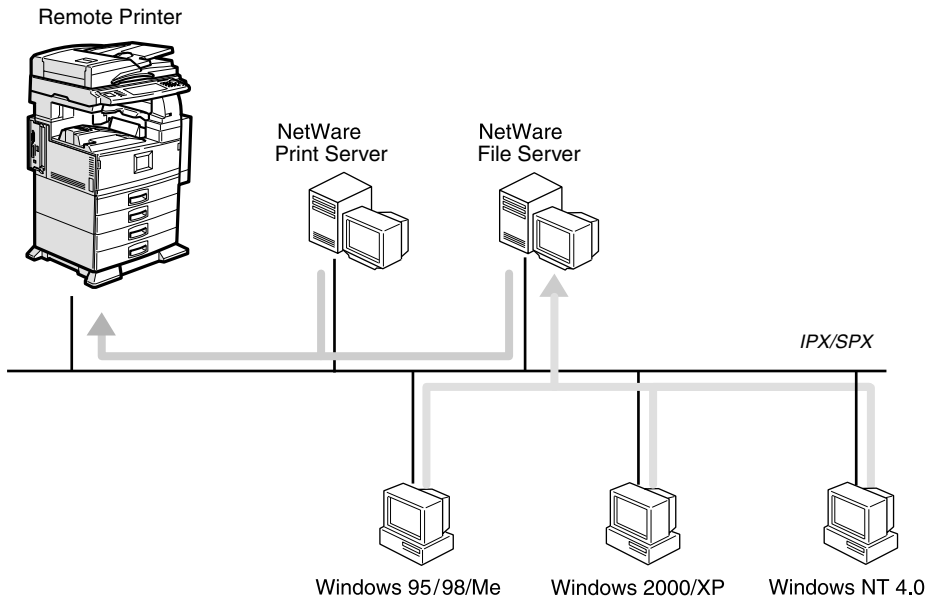

❖ **Printing with UNIX**

For UNIX printing information, visit our Web site or consult your authorized dealer.

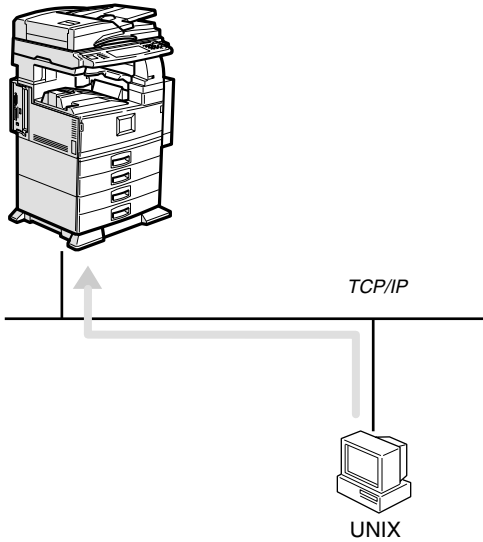

5

Printing with Windows

Printing with a Windows 2000/XP or Windows NT Print Server

This describes how to configure a client computer on a network using Windows 2000/XP, Windows NT Server or Windows NT Workstation as a print server.

When using a Windows 2000/XP or Windows NT print server, select a shared printer on Windows 2000/XP or Windows NT.

This section describes running **[Add Printer Wizard]** on each client computer, and adding the Windows 2000, Windows XP, and Windows NT 4.0 print servers as the network printer.

These instructions are for Windows 98.

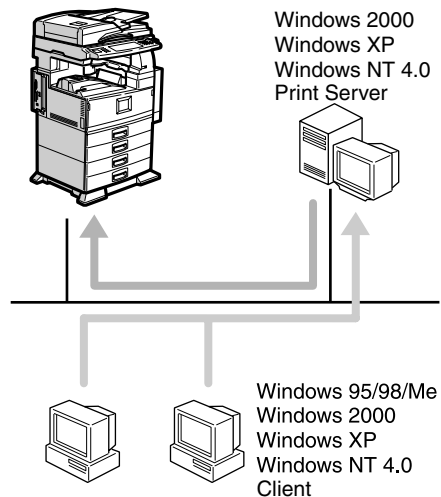

! Limitation

- When using a print server connected to the machine with SmartNetMonitor for Client, you cannot use Recovery Printing and Parallel Printing.
- When using Windows XP as a print server, the client computer cannot receive notification of print job completion.

Note

- This section assumes the client is already configured to communicate with a Windows 2000/XP or Windows NT print server. Do not begin the following procedure until the client computer is set up and configured correctly.
- When using Windows NT 4.0 as the print server, make sure you install the Windows NT 4.0 printer driver before connecting the print server. There is a Windows NT 4.0 printer driver on the CD-ROM labeled "Printer Drivers and Utilities".

1 On the [Start] menu, point to [Settings], and then click [Printers].

2 Click the icon of the printer you want to use. On the [File] menu, click [Properties].

3 Click the [Details] tab, and then click [Add Port].

4 Click [Network], and then click [Browse].

5 On the network tree, double-click the name of the computer used as the print server.

The printers connected to the network are displayed.

6 Click the name of the printer you want to use, and then click [OK].

7 Click [OK].

8 Make sure the port name is displayed in the [Print to the following port] box, and then click [OK].

Printing without a Print Server

You can use this machine as a network printer without connecting to a print server.

You can configure the following ports:

❖ SmartNetMonitor

You can print via TCP/IP, IPP, or NetBEUI using SmartNetMonitor.

Note

- Install SmartNetMonitor for Client from the supplied CD-ROM. For more information about installation, see *Printer Reference 1*.
- For more information about SmartNetMonitor for Client, see p.71 "Using SmartNetMonitor for Client".

❖ Standard TCP/IP port

You can print via TCP/IP using a standard TCP/IP port.

❖ LPR port

You can print via TCP/IP using an LPR port.

Changing port settings

This describes how to change the port settings under Windows 2000 when a printer driver has been installed.

1 In the **[Printers]** window, click the icon of the printer you want to use. On the **[File]** menu, click **[Properties]**.

2 Click the **[Ports]** tab, and then click **[Add Port]**.

Select the port you want to use.

SmartNetMonitor

1 Click **[SmartNetMonitor]**, and then click **[New Port]**.

2 Select the printer you want to use.

❖ TCP/IP

1 Click **[TCP/IP]**, and then click **[Search(S)]**.

Available printers are listed.

2 Click the printer you want to use, and then click **[OK]**.

Note

- Printers that respond to a broadcast from the computer will be displayed. To print to a printer not listed here, click **[Specify Address(P)]**, and then enter the printer's IP address or host name.

❖ NetBEUI

Note

- Do not use NetBEUI under Windows XP.
- 1** Click **[NetBEUI]**, and then click **[Search(S)]**. Available printers are listed.

2 Click the printer you want to use, and then click **[OK]**.

Note

- Printers that respond to a broadcast from the computer will be displayed. To print to a printer not listed here, click **[Specify Address(P)]**, and then enter the NetBEUI address. Confirm the NetBEUI address on the network appears on the configuration page. For more information about printing the configuration page, see *Printer Reference 2*. NetBEUI addresses appear as "\\RNPxxxx\xxx" on the configuration page. Enter the printer's network path name in the format: "%Computer name\Share name". Do not enter "\\\" as head characters but "%%".

- You cannot print to printers beyond routers.

❖ IPP

1 Click **[IPP]**.

The IPP setting dialog box appears.

2 To specify the IP address of the printer, enter "http://printer's IP address/printer" or "ipp://printer's IP address/printer" in the **[Printer URL(U)]** box.

(Example: IP address is 192.168.15.16)

```
http://192.168.15.16/printer
ipp://192.168.15.16/printer
```

- ③ If necessary, enter the name to identify the printer in the **[IPP Port Name(I)]** box. Enter a different name from those of any existing port name.
If you do not do this, the address entered in the **[Printer URL(U)]** box is set as the IPP port name.
 - ④ If a proxy server and IPP user name are used, click **[Detailed Settings]** and make the necessary settings.
 - ⑤ Click **[OK]**.
- ③ Click **[OK]**.
 - ④ Check the location for the selected printer, and click **[Close]**.

Standard TCP/IP Port

- ① Click **[Standard TCP/IP]**, and then click **[New Port]**.
- ② In the **[Add Standard TCP/IP Printer Port Wizard]** dialog box, click **[Next]**.
- ③ In the **[Printer Name or IP Address]** box, enter the printer name or IP address, and then click **[Next]**.
- ④ In the **[Add Standard TCP/IP Printer Port Wizard]** dialog box, click **[Finish]**.

LPR Port

- ① Click **[LPR Port]**, and then click **[New Port]**.
- ② In the **[Name or address of server providing lpd]** box, enter the printer's IP address.
- ③ In the **[Name of printer or print queue on that server]** box, enter "lp", and then click **[OK]**.

Printing with a Macintosh

This describes how to configure a Macintosh computer to use EtherTalk. Actual procedures may vary depending on the version of the Mac OS. The following procedures describe how to configure Mac OS 9.1 and Mac OS X v10.1. If you are using other version than Mac OS 9.1 and Mac OS X v10.1, see the manual that comes with Mac OS for more information.

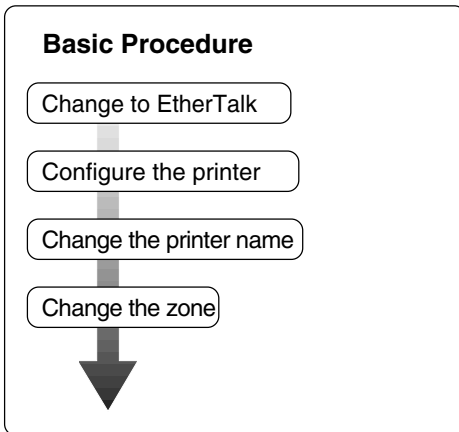

Note

- Mac OS 8.6 and later versions are supported (except for Mac OS X v10.0.x).
- To print from a Macintosh, PostScript 3 option is required.

Changing to EtherTalk

Follow the procedure below to configure a Macintosh computer to use EtherTalk.

Reference

For more information about installing the software required for EtherTalk, see the Macintosh manuals.

Mac OS

- 1** Open [Control Panel], and then double-click the AppleTalk icon.
- 2** On the [Connect via] pop-up menu, click [Ethernet].
- 3** If you change zones, select a name on the [Current zone] pop-up menu.
- 4** Close the [AppleTalk] control panel.
- 5** Restart the Macintosh.

Mac OS X

Note

- You need an administrator name and a password (phrase). For more information, consult your administrator.

- 1** Open [System Preferences], and then click the Network icon.
- 2** From the [show] menu, select [Built-in Ethernet].
- 3** Click the [AppleTalk] tab.

- 4 If you change zones, select a name on the [AppleTalk Zone:] pop-up menu.
- 5 When the setting is complete, click [Apply Now].

Configuring the Printer

Use the control panel to activate the AppleTalk protocol. (The default is active.)

Reference

For more information about configuration, see p.34 “Interface Settings/Network”.

Changing the Printer Name

If the network has several similar model printers, the names will be the same. Printers with the same name will have slightly different names in the [Chooser] dialog box. For example, three printers named “printer” will appear in the [Chooser] dialog box as “printer0”, “printer1”, and “printer2”.

To change the printer name in the Macintosh EtherTalk environment, use Printer Utility for Mac included on the CD-ROM labeled “Printer Drivers and Utilities”.

Changing the Zone

To change the zone configuration in a Macintosh EtherTalk environment, use Printer Utility for Mac included on the CD-ROM labeled “Printer Drivers and Utilities”.

Reference

For more information about using Printer Utility for Mac, see *PostScript 3 Supplement*, provided as a PDF file on the CD-ROM labeled “Operating Instructions for Printer/Scanner”.

Printing with NetWare

This describes how to configure the machine for use as a print server or remote printer in a NetWare environment.

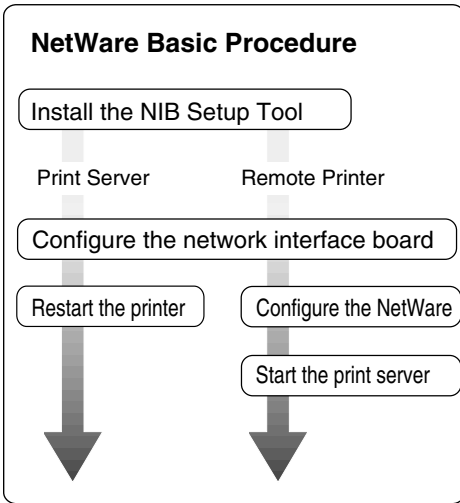

5

This section assumes NetWare is functional and the necessary environment for the NetWare print service is available.

Note

- ❑ NetWare must be set to active using the machine's control panel. For more information about how to set it, see p.17 "Setting Up the Machine on a Network".

❖ **SmartNetMonitor for Admin**

To use a printer in a NetWare environment, configure the NetWare printing environment using SmartNetMonitor for Admin.

Note

- ❑ If you configure NetWare printing using SmartNetMonitor for Admin under the following environments, NetWare Client from Novell is required:
 - NDS mode in Windows 95/98/Me
 - NDS or Bindery mode in Windows 2000/Windows NT 4.0

❖ **Printers listed by SmartNetMonitor for Admin**

SmartNetMonitor for Admin displays a list of printers that are connected to the network. If you cannot find the printer from the displayed list, refer to the configuration page printed from the machine. For more information about printing a configuration page, see *Printer Reference 2*.

Setting Up as a Print Server

NetWare 3.x

1 Log on to the file server as a Supervisor, or equivalent.

2 Start SmartNetMonitor for Admin.

3 On the [Group] menu, point to [Search Device], and then click [IPX/SPX].

A list of machines appears.

4 In the list, select the printer for which you want to change configuration.

5 On the [Tools(T)] menu, click [NIB Setup Tool].

NIB Setup Tool starts.

6 Click [Wizard], and then click [OK]. The [NIB Setup Tool - Network board list] dialog box of the network interface board appears.

7 If necessary, enter the print server name in the [Device Name(D):] box, and then click [Next(N) >].

8 Select the [NetWare] check box, and then click [Next(N) >].

9 Click [Bindery Mode(I)], enter the file server name in the [File Server Name(F):] box, and then click [Next(N) >].

- In the [File Server Name(F):] box, enter the file server name (up to 47 alphanumeric characters) of the server to make the print server. You can also click [Browse(B)...] to select a file server in the [Browse(B)...] dialog box.

10 Enter the print server name in the [Print Server Name(P):] box, the printer name in the [Printer Name(N):] box, and the print queue name in the [Print Queue Name(Q):] box, then click [Next(N) >].

- In the [Print Server Name(P):] box, enter the name of the NetWare print server using up to 47 characters.
- In the [Printer Name(N):] box, enter the name of the NetWare printer using up to 47 characters.
- In the [Print Queue Name(Q):] box, enter the name of the print queue to be added to NetWare.

11 After confirming the settings, click [Next(N) >].

The settings take effect, and NIB Setup Tool closes.

12 Quit SmartNetMonitor for Admin.

13 Restart the printer.

Note

- To make sure the printer is correctly configured, enter the following from the command prompt:

```
F:> USERLIST
```

- If the printer works as configured, the name of the print server appears as an attached user.

NetWare 4.x, 5/5.1, 6

Important

You must set up the print server using NDS mode in NetWare 4.x, 5/5.1, 6.

❖ To use NetWare 5/5.1, 6

- Use the printer as a print server. Do not use it as a remote printer in a PureIP environment.
- If you use PureIP, configure the machine to use TCP/IP. For more information about how to make the settings, see p.17 “Setting Up the Machine on a Network”.

1 Log on to the file server as an administrator, or equivalent.

2 Start SmartNetMonitor for Admin.

3 On the [Group] menu, point to [Search Device], and then click [IPX/SPX] or [TCP/IP].

A list of machines appears.

4 In the list, select the printer for which you want to change configuration.

5 On the [Tools(T)] menu, click [NIB Setup Tool].

NIB Setup Tool starts.

Reference

If you use NetWare 5/5.1 or NetWare 6.0 in a PureIP environment, see p.61 “Using PureIP in the NetWare 5/5.1, 6 environment”.

6 Click [Wizard], and then click [OK].

The [NIB Setup Tool - Network board list] dialog box of the network interface board appears.

7 If necessary, enter the print server name in the [Device Name(N):] box, and then click [Next(N) >].

8 Select the [NetWare] check box, and then click [Next(N) >].

9 Click [NDS Mode(D):], enter the file server name in the [File Server Name(F):] box, the NDS tree name in the [NDS Tree(T):] box and the context in the [NDS Context(C):] box, and then click [Next(N) >].

- In the [File Server Name(F):] box, enter the file server name (up to 47 alphanumeric characters) of the server to make the print server. You can also click [Browse(B)...] to select a file server in the [Browse(B)...] dialog box.

- In the [NDS Tree(D):] box, enter the NDS tree name (using up to 32 alphanumeric characters) of the NDS tree in which you want to make the print server. [Browse(D)...] to select an NDS tree from those listed in the [Browse(D)...] dialog box.

- In the [NDS Context(C):] box, enter the NDS context in which to make the print server. As context, object names are entered in lower object order and divided by a period. For example, if you want to create a print server in NET under DS, enter "NET.DS".



10 Enter the print server name in the [Print Server Name(P:)] box, the printer name in the [Printer Name(N:)] box, the print queue name in the [Print Queue Name(Q:)] box, and the print queue volume in the [Queue Volume(V):], and then click [Next(N) >].

- In the [Print Server Name(P:)] box, enter the name of the NetWare print server using up to 47 characters.
- In the [Printer Name(N:)] box, enter the name of the NetWare printer using up to 47 characters.
- In the [Print Queue Name(Q:)] box, enter the name of the print queue to be added to NetWare.
- In [Queue Volume(V):], enter the print queue volume. As a volume, object names are entered from a lower object and divided by a period. By clicking [Browse(R)...], you can select a volume among those listed in the [Browse(R)...] dialog box.

11 After confirming the settings, click [Next(N) >].

12 Click [Finish].

The settings take effect, and NIB Setup Tool closes.

13 Quit SmartNetMonitor for Admin.

14 Restart the printer.

 **Note**

- To make sure the printer is correctly configured, enter the following from the command prompt:

```
F: >NLIST USER /A/B
```

- If the printer works as configured, the name of the print server appears as an attached user.

Using PureIP in the NetWare 5/5.1, 6 environment

 **Note**

- When not using IPX, it is recommended that you change the print server protocol in the Web browser from [TCP/IP+IPX] to [TCP/IP].

1 Log on to the file server as an administrator, or equivalent.

2 Start SmartNetMonitor for Admin.

3 On the [Group] menu, point to [Search Device], and then click [IPX/SPX].

A list of machines appears.

4 In the list, select the printer for which you want to change configuration.

5 On the [Tools(T)] menu, click [NIB Setup Tool].

NIB Setup Tool starts.

6 Click [Property Sheet], and then click [OK].

The [NIB Setup Tool - Network board list] dialog box of the network interface board appears.

7 If necessary, enter the print server name in the [Device Name(N):] box.

8 Click the **[NetWare]** tab, and then make the following settings:

1 In the **[Logon Mode]** area, click **[File Server Mode]** or **[NDS Mode]**.

 **Note**

- If **[File Server Mode]** is selected, a connecting destination will be chosen based on the string entered in step **3**.
- If **[NDS Mode]** is selected, a connecting destination will be chosen based on the string entered in step **4**.

2 In the **[Print Server Name(P):]** box, enter the name of the print server.

 **Limitation**

- Enter up to 47 alphanumeric characters.

3 In the **[File Server Name(F):]** box, enter the name of the file server in which the print server is to be created.

By clicking **[Browse(B)...]**, you can select a file server among those listed in the **[Browse(B)...]** dialog box.

 **Limitation**

- Enter up to 47 alphanumeric characters.

4 In the **[NDS Tree(T):]** box, enter the NDS tree name in which to make the file server.

By clicking **[Browse(D)...]**, you can select the NDS tree name and NDS context name from their lists.

 **Limitation**

- Enter up to 32 alphanumeric characters("-" and "_" can be used).

5 In the **[NDS Context(C):]** box, enter the context of the print server.

 **Limitation**

- Enter up to 127 alphanumeric characters.

 **Note**

- As context, object names are entered in lower object order and divided by a period. For example, if you want to create a print server into NET under DS, enter "NET.DS".



6 In the **[Print Server Operation Mode]** area, click **[As Print Server(S)]**.

7 Click **[OK]** to close the **[NIB Setup Tool - Network board list]** dialog box.

9 **Quit SmartNetMonitor for Admin.**

After this step, operate the machine by following the procedure from step **9** on p.65 "NetWare 4.x, 5/5.1, 6". However, steps **11-3** and **11-4** are not required.

Setting Up as a Remote Printer

NetWare 3.x

1 Log on to the file server as an administrator, or equivalent.

2 Start SmartNetMonitor for Admin.

3 On the [Group] menu, point to [Search Device], and then click [IPX/SPX].

A list of machines appears.

4 In the list, select the printer for which you want to change configuration.

5 On the [Tools(T)] menu, click [NIB Setup Tool].

NIB Setup Tool starts.

6 Click [Property Sheet], and then click [OK].

The [NIB Setup Tool - Network board list] dialog box appears.

7 Click the [NetWare] tab, and then make the following settings:

1 In the [Print Server Name(P):] box, enter the name of the print server.

⚠ Limitation

Enter up to 47 alphanumeric characters.

2 In the [File Server Name(F):] box, enter the name of the file server in which a print server is to be created.

By clicking [Browse(B)...], you can select a file server among those listed in the [Browse(B)...] dialog box.

⚠ Limitation

Enter up to 47 alphanumeric characters.

3 In the [Print Server Operation Mode] area, click [As Remote Printer(R)].

4 In the [Remote Printer No.(N)] box, enter the printer number.

⚠ Important

Use the same printer number as that to be created in the print server.

5 Click [OK] to close the [NIB Setup Tool - Network board list] dialog box.

8 Quit SmartNetMonitor for Admin.

9 Enter "PCONSOLE" from the command prompt.

```
F: > PCONSOLE
```

10 Create a print queue as follows:

📝 Note

If you are using a currently defined print queue, proceed to step **11**

1 On the [Available Options] menu, click [Print Queue Information], and then press the [ENTER] key.

2 Press the [INSERT] key, and then enter a print queue name.

3 Press the [ESCAPE] key to return to the [Available Options] menu.

11 Create a printer as follows:

- 1 On the [Available Options] menu, click [Print Server Information], and then press the [ENTER] key.
- 2 To create a new print server, press the [INSERT] key, and then enter a print server name.

 **Note**

- If you are using a currently defined print server, select one of the print servers shown in the [Print Server] list.

 **Important**

- Use the same name as that specified in NIB Setup Tool. (Step 7-1).

- 3 On the [Print Server Information] menu, click [Print Server Configuration].
- 4 On the [Print Server Configuration] menu, click [Printer Configuration].
- 5 Select the printer indicated as "Not Installed".

 **Important**

- Use the same number as that specified as the Remote Printer No. using NIB Setup Tool. (Step 7-4).

- 6 If you want to change the printer name, enter a new name.

 **Note**

- The name "Printer x" is assigned to the printer. "x" stands for the number of the selected printer.

- 7 Click [Remote Parallel, LPT1] as the printer type.

IRQ, Buffer size, Starting form, and Queue service mode are automatically configured.

- 8 Press the [ESC] key, and then click [Yes] when the confirmation message appears.

- 9 Press the [ESC] key to return to the [Print Server Configuration] menu.

12 Assign print queues to the created printer as follows:

- 1 On the [Print Server Configuration] menu, click [Queues Serviced By Printer].

- 2 Select the printer created in step 11.

- 3 Press the [INSERT] key to select a queue serviced by the printer.

 **Note**

- You can select more than one queue at a time.

- 4 Follow the instructions on screen to make other necessary settings.

When you have finished the above procedure, make sure the queues are assigned.

- 13 Press the [ESC] key until the "Exit?" appears, and then click [Yes] to quit PCONSOLE.

- 14 Start the print server by entering the following from the NetWare server's keyboard.

If it is running, restart after quitting.

❖ **To quit**

```
CAREE: unload pserver
```

❖ **To start**

```
CAREE: load pserver
print_server_name
```

 **Note**

- If the printer works as configured, "Waiting for job" appears.
- NetWare 3.x ends here.

NetWare 4.x, 5/5.1, 6

1 Log on to the file server as an administrator, or equivalent.

2 Start SmartNetMonitor for Admin.

3 On the [Group] menu, point to [Search Device], and then click [IPX/SPX].

A list of machines appears.

4 In the list, select the printer for which you want to change configuration.

5 On the [Tools(T)] menu, click [NIB Setup Tool].

NIB Setup Tool starts.

6 Click [Property Sheet], and then click [OK].

The [NIB Setup Tool - Network board list] dialog box appears.

7 Click the [NetWare] tab, and then make the following settings:

1 In the [Logon Mode] area, select [File Server Mode] or [NDS Mode].

 **Note**

If [File Server Mode] is selected, a connecting destination will be chosen based on the string entered in step **3**.

If [NDS Mode] is selected, a connecting destination will be chosen based on the string entered in step **4**.

2 In the [Print Server Name(P):] box, enter the name of the print server.

 **Important**

Use the same name as that of the print server name to be set from NWadmin(**F3**-**3**).

 **Limitation**

Enter up to 47 alphanumeric characters.

3 In the [File Server Name(F):] box, enter the name of the file server in which a print server is to be created.

By clicking [Browse(B)...], you can select a file server among those listed in the [Browse(B)...] dialog box.

 **Limitation**

Enter up to 47 alphanumeric characters.

4 In the [NDS Tree(T):] box, enter the NDS tree name in which to make the file server.

By clicking [Browse(D)...], you can select the NDS tree name and NDS context name from their lists.

 **Limitation**

Enter up to 32 alphanumeric characters("-" and "_" can be used).

5 In the [NDS Context(C):] box, enter the context in which the print server is to be created.

 **Limitation**

Enter up to 127 alphanumeric characters.

6 In the [Print Server Operation Mode] area, click [As Remote Printer(R)].

7 In the [Remote Printer No.(N)] box, enter the number of the printer.

 **Important**

Use the same number as that of the printer to be created in the print server(**F4**-**4**).

8 Click [OK] to close the [NIB Setup Tool - Network board list] dialog box.

8 Quit SmartNetMonitor for Admin.

9 On Windows, start NWadmin.

Reference

For more information about NWadmin, see the operating instructions that come with the NetWare.

10 Create a print queue as follows:

Note

If you are using a currently defined print queue, proceed to step **11**.

1 Select the container object the print queue is located in from those in the directory tree, and then click [Create] on the [Object] menu.

2 In the [Class of new object] box, click [Print Queue], and then click [OK].

3 In the [Print Queue name] box, enter the name of the print queue.

4 In the [Print Queue Volume] box, click [Browse].

5 In the [Available objects] box, click the volume in which the print queue is created, and then click [OK].

6 After checking the settings, click [Create].

11 Create a printer as follows:

1 Select the container object where the printer is located, and then click [Create] on the [Object] menu.

2 In the [Class of new object] box, click [Printer], and then click [OK]. If you are using NetWare 5/5.1, 6, click [Printer (Non NDPS)].

3 In the [Printer name] box, enter the name of the printer.

4 Select the [Define additional properties] check box, and then click [Create].

12 Assign print queues to the created printer as follows:

1 Click [Assignments], and then click [Add] in the [Assignments] area.

2 In the [Available objects] box, click the queue created in step **11**, and then click [OK].

3 Click [Configuration], and in the [Printer type] list, click [Parallel], and then click [Communication].

4 In the [Communication type] area, click [Manual load], and then click [OK].

5 After checking the settings, click [OK].

13 Create a print server as follows:

1 Select the context specified using NIB Setup Tool (Step **7-2**), and on the [Object] menu, click [Create].

2 In the [Class of new object] list, click [Print Server], and then click [OK].

If you are using NetWare 5/5.1, 6, click [Print Server (Non NDPS)].

3 In the [Print Server name] box, enter the name of the print server.

Important

Use the same name as that specified using NIB Setup Tool (step **7-2**).

4 Select the [Define additional properties] check box, and then click [Create].

14 Assign the printer to the created print server as follows:

- 1 Click [Assignments], and then click [Add] in the [Assignments] area.
- 2 In the [Available objects] box, click the queue created in step 10, and then click [OK].
- 3 In the [Printers] box, click the printer assigned in step 2, and then click [Printer Number].
- 4 Enter the printer number, and then click [OK].

Important

- Use the same number as that specified as Remote Printer No. using NIB Setup Tool (step 7-7).
- 5 After checking the settings, click [OK].

15 Start the print server by entering the following from the NetWare server's keyboard.

If it is running, restart after quitting.

❖ To quit

```
CAREE: unload pserver
```

❖ To start

```
CAREE: load pserver
print_server_name
```

Setting Up a Client Computer

This describes how to set up a client computer when using a NetWare print server.

Note

- Use the version of Novell Client provided with your operating system, or the latest version.
- This section assumes the client computer has NetWare client applications installed and is correctly configured to communicate with a NetWare print server. If it is not, install the necessary applications before starting the setting up procedure.

Windows 95/98/Me

Follow the procedure below to set up a Windows 95/98/Me client computer:

Preparation

Log on to the NetWare file server before starting the following procedure:

1 Install the printer driver you want to use as "local printer".

Reference

For more information about installing the printer driver, see *Printer Reference 1*.

Note

- Any port can be selected during installation. However, LPT1 is recommended.

2 On the [Start] menu, point to [Settings], and then click [Printers].

3 In the [Printers] window, click the icon of the printer you want to use.

4 On the [File] menu, click [Properties].

5 Click the [Details] tab, and then click [Add Port].

6 Click [Network], and then click [Browse].

7 In the tree pane, double-click the name of the file server.

The queues are displayed.

8 Select the queue you want to print, and then click [OK].

9 Click [OK].

In the [Print to the following port] box, a network path to the printer appears.

10 Click [OK] to close the printer properties dialog box, and open it again.

11 Click the [Printer Settings] tab.

12 Clear the [Form feed] and [Enable banner] check boxes.

 **Note**

- You do not have to select these boxes because they should be specified in the printer driver. If they are selected, the printer might not print correctly.

When using the PostScript printer driver

Follow the procedure below to set the PostScript printer driver:

1 Click the [PostScript] tab.

2 Click [Advanced].

3 Clear the [Send CTRL+D before job] and [Send CTRL+D after job] check boxes.

13 Click [OK] to close the printer properties dialog box.

Windows 2000/XP, Windows NT 4.0

Follow the procedure below to set up a Windows 2000/XP, Windows NT 4.0 client computer.

 **Preparation**

Log on to the NetWare file server before starting the following procedure:

1 Double-click the My Network Places icon on the desktop, and then double-click.

The [Printers] dialog box appears.

 **Note**

- When using Windows NT 4.0, the Network Neighborhood icon appears on the desktop instead of the My Network Places icon.

2 Click [Yes], and then click [OK].

Add Printer Wizard starts.

3 Insert the CD-ROM labeled "Printer Drivers and Utilities" into the CD-ROM drive, and then click [Have Disk].

If the setup menu starts automatically, you can proceed to the next step. If not, see *Printer Reference 1*.

4 Follow the instructions on screen to complete installation of the printer driver.

 **NDPS**

The machine operates using NDPS. Operating requirements are as follows:

- NetWare Version: 5.0, 5.1, 6

❖ **Printer Drivers and Operating Systems**

Printer driver	Operating system
PCL	Windows 95/98/Me Windows 2000 Windows XP Professional Windows NT 4.0
PostScript 3	Windows 95/98/Me Windows 2000 Windows XP Professional Windows NT 4.0

To use the machine with NDPS, NDPS Gateway is required.

- **Novell NDPS Gateway**
For more information about using Novell NDPS Gateway, see the manual provided with it.
- **Custom NDPS Gateway**
For more information about using Custom NDPS Gateway, consult your authorized retailer.

 **iPrint**

This machine does not support iPrint.

6. Using SmartNetMonitor for Client

SmartNetMonitor for Client

SmartNetMonitor for Client is equipped with the following functions. We recommend all users of this printer to install this software.

❖ Protocol Stack

Operating system	Protocol stack
Microsoft Windows 95/98/Me	TCP/IP provided with Windows 95/98/Me IPX/SPX provided with Windows 95/98/Me NetBEUI provided with Windows 95/98/Me NetWare network client provided with Windows 95/98/Me Novell Client for Windows 95/98/Me
Microsoft Windows 2000	TCP/IP provided with Windows 2000 IPX/SPX provided with Windows 2000 NetBEUI provided with Windows 2000 NetWare Client provided with Windows 2000 Novell Client for Windows NT/2000/XP
Microsoft Windows XP	TCP/IP provided with Windows XP IPX/SPX provided with Windows XP NetWare Client provided with Windows XP Novell Client for Windows NT/2000/XP
Microsoft Windows NT 4.0	TCP/IP provided with Windows NT IPX/SPX provided with Windows NT NetBEUI provided with Windows NT Client Service for NetWare provided with Windows NT Novell Client for Windows NT/2000/XP

❖ What can it do?

- Peer-to-Peer print function
 - Prints directly on the network printer without a print server.
 - Prints on a substitute printer if too many jobs accumulate in the specified printer, or an error disables printing (Recovery Printing).
 - Allocates multiple printings to multiple printers (Parallel Printing).
 - Prior group registration of printers specified for Recovery Printing /Parallel Printing.

- Notification function
 - An error message appears if there is an error on the specified printer during transfer or printing of data.
 - A window opens to notify you of print completion. You can also select to be notified of the print condition, such as displaying the notice only when Recovery Printing is executed.
 - You can have a completion notice appear after printing, document storage, and LAN-Fax transmission.
- An error message can be displayed if an error occurs during printing or transmission of a print job.
- Monitoring function
 - Checks the equipment to give you information about printing, paper levels, etc., via your computer.
 - Simultaneously monitors multiple printers in use.
 - Checks the printer's network settings and detailed information of devices.
 - Enables you to check the print job log using the user ID.
- Reports print completion and document storage using the printer function, and print completion, document storage and transmission by the LAN-Fax function.
- Up to 100 print jobs can be displayed.

Limitation

- Make the same settings for the option configuration of the printer for Recovery/Parallel Printing and the printer for giving print commands. If the options necessary for printing, such as the paper feed unit, are not installed on the substitute printer, that function is disabled.
- Load paper of the same size on both the printer for Recovery/Parallel Printing and the printer for giving print commands. When specifying a particular paper tray for printing, load paper of the same size into that tray.
- If the type and devices of the printer for Recovery/Parallel Printing and the printer for giving commands are different, print results might not be identical.
- If you select Sample Print or Locked Print, you cannot execute Recovery/Parallel Printing.

Reference

For more information about using Recovery Printing/Parallel Printing, see SmartNetMonitor for Client Help.

Setting the Network Monitoring Function

To view the status of machines using SmartNetMonitor for Client, you must configure SmartNetMonitor for Client in advance, so that it monitors the machine whose status you want to view.

1 Start SmartNetMonitor for Client.

The SmartNetMonitor for Client icon appears at the right end of the taskbar.

2 Right-click the SmartNetMonitor for Client icon, and check the desired machine is on the shortcut menu that appears.

For details about the machine status icon, see SmartNetMonitor for Client Help.

3 If the desired machine does not appear, click [Options(O)...] on the shortcut menu.

The [SmartNetMonitor for Client - Options] dialog box appears.

4 Select the machine to be monitored, and select the [To be Monitored(T)] check box in the [Monitoring Information Settings] area.

Note

- Selecting the [Displayed on Task Bar] check box will bring up the status of a machine on the SmartNetMonitor for Client icon on the taskbar.

5 Click [OK].

The dialog box closes and the selected machine is monitored.

Displaying the Status of Machines

Follow the procedure below to monitor machine status using SmartNetMonitor for Client.

1 Start SmartNetMonitor for Client.

2 The status of machines is displayed on the SmartNetMonitor for Client icon on the taskbar.

Note

- For more information about status icons, see SmartNetMonitor for Client Help.

3 For further information on status, right-click the SmartNetMonitor for Client icon, and then select the desired machine.

The status of the machine is displayed in the dialog box.

Note

- For more information about each item in the dialog box, see SmartNetMonitor for Client Help.

7. Using SmartNetMonitor for Admin

SmartNetMonitor for Admin

Using SmartNetMonitor for Admin, not only can you monitor the status of network printers, but you can also change the configuration of the network interface board using TCP/IP or IPX/SPX protocol.

❖ Protocol Stack

Operating system	Protocol stack
Microsoft Windows 95/98/Me	TCP/IP provided with Windows 95/98/Me IPX/SPX provided with Windows 95/98/Me NetWare network client provided with Windows 95/98/Me Novell Client for Windows 95/98/Me
Microsoft Windows 2000	TCP/IP provided with Windows 2000 IPX/SPX provided with Windows 2000 NetWare Client provided with Windows 2000 Novell Client for Windows NT/2000/XP
Microsoft Windows XP	TCP/IP provided with Windows XP IPX/SPX provided with Windows XP Novell Client for Windows NT/2000/XP
Microsoft Windows NT 4.0	TCP/IP provided with Windows NT IPX/SPX provided with Windows NT Client Service for NetWare provided with Windows NT Novell Client for Windows NT/2000/XP

❖ What can it do?

- Limits settings done from the control panel, and disables changes made to certain items.
- Enables selection of paper type loaded in the machine.
- Switches to, and comes out of Energy Saver mode.
- Checks information about printing, paper quantity, etc.
- Simultaneously monitors multiple printers. When there are many printers, you can create groups and classify printers to facilitate management.
- Checks the machine's network settings and detailed device information.
- Enables you to change the machine's network settings.
- You can check details of print jobs sent from a computer.
- Allows you to check job histories of printed, faxed (LAN-Fax), scanned, and photocopied documents identified by user codes.

- Allows selection of functions such as printing and scanning for each user code.
- Fax numbers and e-mail addresses stored in the machine can be changed and saved by computer.
- You can check each fax job history entry.
- You can make settings for and display the status changes of group devices.
- Using Address Management Tool, you can manage LAN-Fax numbers, user names for Scan to Folder, and addresses for sending and receiving Internet faxes.
- The e-mail sender's name and folder can be protected.

 **Reference**

For more information about these settings, see SmartNetMonitor for Admin Help.

 **Limitation**

TCP/IP is required for the following functions:

- Using Tools
 - Locking the Control Panel Menu
 - Selecting the Paper Type
 - Managing User Information
 - Address Management Tool
 - Load Fax Journal
 - Viewing and Deleting Spool Print Jobs
 - Starting the Web browser using SmartNetMonitor for Admin

Changing the Network Interface Board Configuration

Limitation

- Internet Explorer 4.01 or a later version is required to use NIB Setup Tool.

1 Start SmartNetMonitor for Admin.

2 On the [Group] menu, point to [Search Device], and then click [TCP/IP] or [IPX/SPX].

A list of machines appears.

Note

- Select the protocol of the machine for which you want to change configuration.

3 In the list, select the machine for which you want to change configuration.

4 On the [Tools(T)] menu, click [NIB Setup Tool].

NIB Setup Tool starts.

5 Click [Property Sheet], and then click [OK].

Network Board Selection Wizard starts.

6 Follow the instructions on the screen.

Note

- For more information about changing machine names, comments, and other items, see NIB Setup Tool Help.

Displaying Machine Status

Follow the procedure below view the status of machines using SmartNetMonitor for Admin.

1 Start SmartNetMonitor for Admin.

2 On the [Group] menu, point to [Search Device], and then click [TCP/IP] or [IPX/SPX].

The status of machines is indicated by an icon in the list.

Note

- For more information about status icons, see SmartNetMonitor for Admin Help.

3 For further information, select the desired machine in the list, and then click [Open] on the [Device(D)] menu.

The status of the machine is displayed in the dialog box.

Note

- For more information about each item in the dialog box, see SmartNetMonitor for Admin Help.

Locking the Control Panel Menu

- 1 Start SmartNetMonitor for Admin.
- 2 On the [Group] menu, point to [Search Device], and then click [TCP/IP] or [IPX/SPX].

A list of machines appears.

 **Note**

- Select the protocol of the machine for which you want to change configuration.

- 3 In the list, select the machine for which you want to change configuration.

- 4 On the [Tools(T)] menu, point to [Device Settings], and then click [Lock Operation Panel Menu].

The dialog box for entering the password appears.

- 5 Enter your user name and password, and then click [OK].

 **Note**

- To use the factory default account, enter no user name and enter "password" for the password.

Check the device status on the Device Settings of the Web browser, and change the device settings.

 **Reference**

For more information about viewing status information and changing settings using a Web browser, see Device Settings Help.

Selecting the Paper Type

- 1 Start SmartNetMonitor for Admin.
- 2 On the [Group] menu, point to [Search Device], and then click [TCP/IP] or [IPX/SPX].

A list of machines appears.

 **Note**

- Select the protocol of the machine for which you want to change configuration.

- 3 In the list, select the machine for which you want to change configuration.

- 4 On the [Tools(T)] menu, point to [Device Settings], and then click [Select Paper Type].

The dialog box for entering the password appears.

- 5 Enter your user name and password, and then click [OK].

 **Note**

- To use the factory default account, enter no user name and enter "password" for the password.

Check the device status on the Device Settings of the Web browser, and change the device settings.

 **Reference**

For more information about viewing status information and changing settings using a Web browser, see Device Settings Help.

Managing User Information

1 Start SmartNetMonitor for Admin.

2 On the [Group] menu, point to [Search Device], and then click [TCP/IP] or [IPX/SPX].

A list of machines appears.

 **Note**

- Select the protocol of the machine for which you want to change configuration.

3 In the list, select the machine for which you want to change configuration.

4 On the [Tools(T)] menu, click [User Management Tool].

The dialog box for entering the password appears.

5 Enter the password, and then click [OK].

 **Note**

- The factory default password is “password”.

User Management Tool starts.

For more information about using User Management Tool, see User Management Tool Help.

Load Fax Journal

1 Start SmartNetMonitor for Admin.

2 On the [Group] menu, point to [Search Device], and then click [TCP/IP] or [IPX/SPX].

A list of machines appears.

 **Note**

- Select the protocol of the machine for which you want to change configuration.

3 In the list, select the machine for which you want to change configuration.

4 On the [Tools(T)] menu, click [Load Fax Journal].

5 Check the Load Fax Journal area that appears in the Web browser.

For details, see Help in Load Fax Journal area.

Viewing and Deleting Spool Print Jobs

1 Start SmartNetMonitor for Admin.

2 On the [Group] menu, point to [Search Device], and then click [TCP/IP] or [IPX/SPX].

A list of machines appears.

 **Note**

- Select the protocol of the machine for which you want to change configuration.

3 In the list, select a machine whose numerical values you want to manage.

4 On the [Tools(T)] menu, click [Spool Printing Job List (Printer)].

5 Enter your user name and password, and then click [OK].

 **Note**

- To use the factory default account, enter no user name and enter “password” for the password.

Check Spool Printing Job List on the Web browser, and print out.

Reference

For more information about Spool Printing Job List, see Spool Printing Job List Help.

Note

- To display Spool Printing Job List, spool must be set to **[Enable]** on Device Settings in advance.

Managing Address Information

1 Start SmartNetMonitor for Admin.

2 On the **[Group]** menu, point to **[Search Device]**, and then click **[TCP/IP]** or **[IPX/SPX]**.

A list of machines appears.

Note

- Select the protocol of the machine for which you want to change configuration.

3 In the list, select the machine for which you want to change configuration.

4 On the **[Tools(T)]** menu, click **[Address Management Tool]**.

The dialog box for entering the password appears.

5 Enter the password, and then click **[OK]**.

Note

- The factory default password is "password".

Address Management Tool starts.

Reference

For more information about Address Management Tool, see Address Management Tool Help.

Configuring Energy Saver Mode

1 Start SmartNetMonitor for Admin.

2 On the **[Group]** menu, point to **[Search Device]**, and then click **[TCP/IP]** or **[IPX/SPX]**.

A list of machines appears.

3 On the **[Group]** menu, point to **[Energy Saver Mode]**.

For more information about settings, see SmartNetMonitor for Admin Help.

Note

- Point to **[Set by Group]** if you want to change all devices in the area.
- Point to **[Set Individually]** if you want to change only selected devices.
- In both cases, select the Energy Saver mode on the displayed menu.
- When you point to **[Set Individually]**, **[Timer Settings]** is not displayed.

8. Configuring the Network Interface Board Using a Web Browser

You can check the status of a machine and change its settings using the Web browser.

❖ What can it do?

You can remotely check the status of a machine or specify its settings over the network using a computer's Web browser.

The following functions are available with Web browser:

- Displaying machine status/settings
- Checking print job status/history
- Checking, modifying, printing, or deleting print jobs stored in the Document Server
- Managing the Address Book
- Making machine settings

❖ Configuring the machine

This requires TCP/IP to be installed. After the machine has been configured to use TCP/IP, it will be possible to adjust settings using a Web browser.

Reference

For more information about configuring the machine to use TCP/IP, see p.17 "Setting Up the Machine on a Network".

❖ Browser

- Microsoft Internet Explorer 5.5 or later
- Netscape Navigator 6.2 or later

Limitation

- If the Web browser in use is older than the recommended version or **[JavaScript]** and **[Cookie]** are not available, display and operation problems may occur.
- If you are using a proxy server, change the Web browser settings. Consult your network administrator about the settings.
- Sometimes after clicking **[Back]**, the previous page may not appear. In this case, click **[Refresh]** or **[Reload]**.
- This machine information cannot refresh automatically. Click **[Reload]** or **[Refresh]** on the Web browser, or click **[Refresh]** on the work area when you want to refresh.

❖ Specifying the Address

In the **[Address]** box, enter the address (for example `http://XXX.XXX,XXX,XXX`, where the Xs are the numbers of the IP address). If the host name of the machine is registered on the DNS server or WINS server, you can enter it.

Going to the Top Page

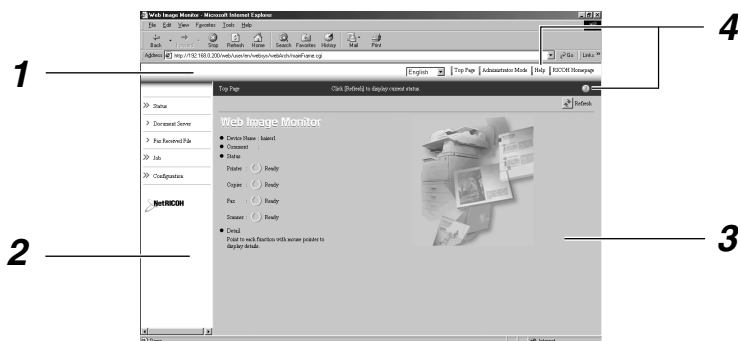

1. Header area

You can register favorite URLs using **[URL]**. To view the Help section, click **[Help]**.

2. Menu area

These buttons are for configuring the network interface board and checking machine status.

3. Status

Displays machine status, network interface board name, and comments.

4. Help

Types of Menu Configuration and Mode

Items that appear on the menu area differ between user mode and administrator mode.

The work area which appears under the selected menu displays machine status under user mode and machine setting under administrator mode.

Note

- Indicates machine status can be displayed.
- Indicates machine settings can be changed.

Menu		User mode	Administrator mode
Status	Input Tray	○	○
	Output Tray	○	○
	Toner	○	○
	Function	○	○
	System	○	○
	Printer Language	○	○
Document Server		●	●
Fax Received File		●	●
Job	Printer	Spool Printing	○
		History	○
	Fax History	Transmission	○
		Reception	○
		LAN-Fax	○
	Document Server		○
Address Book		-	●

Menu		User mode	Administrator mode	
Configuration	Device Settings		- ●	
	E-mail		○ ●	
	File Transfer		- ●	
	Network	Interface		○ ●
		Protocol	TCP/IP	○ ●
			NetWare	○ ●
			AppleTalk	○ ●
			SMB	○ ●
			SNMP	- ●
	System Log		○ ○	
	Webpage		○ ●	
	Password	Password		- ●
		Access Control		- ●
IPP Authentication		- ●		

 **Limitation**

- Documents stored under the copier and printer functions cannot be downloaded.

 **Note**

- Check print results of Document Server jobs in **[Status]** in **[Job History]**.

 **Reference**

For more information about displaying status and changing settings, see p.87 "Using Help on the Web Browser".

Verifying the Network Interface Board Settings

- 1** Start the Web browser.
- 2** In the [Address] box, enter the address (for example `http://XXX.XXX,XXX,XXX`, where the Xs are the numbers of the IP address).

The status of the machine you chose appears on the Web browser.

- 3** In the menu area, click the selected menu.

If a sub-menu appears, click it.

Reference

For more information about each item, see p.87 “Using Help on the Web Browser”.

Configuring the Network Interface Board Settings

1 Start the Web browser.

2 In the [Address] box, enter the address (for example `http://XXX.XXX,XXX,XXX`, where the Xs are the numbers of the IP address).

The status of the machine you chose appears on the Web browser.

3 Click [Administrator Mode].

The dialog box for entering the password and user name appears.

4 Enter your user name and password, and then click [OK].

To use the factory default account, enter no user name and enter “password” for the password.

5 In the menu area, click the selected item, and then make the necessary settings.

6 Click [Apply].

The configuration is transmitted.

Reference

For more information about making settings, see p.87 “Using Help on the Web Browser”.

Using Help on the Web Browser

When using Help for the first time, clicking either **[Help]** in the header area or the icon marked "?" in the work area makes the following screen appear. From there you can check Help in two different ways, as shown below:

❖ Checking a Help Using the Internet

You can check the latest Help updates.

❖ Downloading and Checking Help

You can download Help to your computer's hard drive and view it. As the Help URL, you can specify the path to the local file to view the Help without connecting to the Internet.

Note

- By clicking **[Help]** in the header area, Help contents normally appear.
- By clicking "?", the Help icon in the work area, Help for the items shown in the work area normally appears.

Downloading Help

- 1** In the **[OS]** list, select the operating system.
- 2** In the **[Language]** list, select the language.
- 3** Click **[Download]**.
- 4** Download Help by following the messages on screen.

- 5** Save the downloaded compressed file, and then decompress it.

Note

- To check the downloaded Help, specify the path where the file is decompressed.

Linking the address (URL) to the **[Help]** button

You can link the address (URL) of the **[Help]** button to the Help files on the computer or Web server.

- ① Download the Help files on the computer to the desired location.
- ② Using a Web browser, navigate to Top Page and click **[Administrator Mode]**.
- ③ Enter your password, (it is not necessary to enter a user name) and click **[OK]**.
- ④ Click **[Configuration]**, and then click **[Webpage]**.
- ⑤ In the **[Help URL]** box, enter the path to the Help files.
If you copied the Help files to "C:\HELP\EN", enter "file:///C:/HELP/". For example, if you copied the files to a Web server and the index URL is "http://a.b.c.d/HELP/EN/index.html", enter "http://a.b.c.d/HELP/".
- ⑥ Click **[Apply]**.

Remote Maintenance by telnet

You can view printer status and configure the network interface board using telnet.

Note

- You should specify a password so only the network administrator, or a person with network administrator privileges, can use remote maintenance.
- The password is the same as that used for configuring the network interface board with a Web browser.
- If you change a password using remote maintenance, the other passwords are also changed.

Using telnet

Follow the procedure below to use telnet.

Limitation

- Only one person at a time can be logged on to do remote maintenance.

1 Using the machine's IP address or host name, start telnet.

```
% telnet IP_address
```

Note

- In order to use the host name instead of the IP address, you must write it to the hosts file.

2 Enter the password.

Note

- The default is "password".

3 Enter a command.

Reference

For more information about telnet commands, see p.90 "Commands List".

4 Quit telnet.

```
msh> logout
```

When the configuration changes, a message asks whether the changes should be saved or not.

5 Enter "yes" to save the changes, and then press the [ENTER] key.

If you do not want to save the changes, enter "no", and then press the [ENTER] key. If you want to make additional changes, enter "return", and then press the [ENTER] key.

Note

- If "Cannot write NVRAM information" appears, the changes are not saved. Repeat the steps above, as necessary.
- The network interface board is automatically reset when the changes are saved.
- When the network interface board is reset, active print jobs already sent to the machine will be finished. However, jobs not already sent will be canceled.

Commands List

Use the "help" command to display remote maintenance use.

 **Note**

- Enter "help" to display a list of commands that can be used.

```
msh> help
```

- Enter "help command_name" to display information about the syntax of that command.

```
msh> help command_name
```

TCP/IP address

Use the "ifconfig" command to configure the Ethernet interface, the IEEE 1394 interface/IEEE 802.11b, and the TCP/IP (IP address, subnet mask, broadcast address, default gateway address) for the machine.

❖ **Reference**

```
msh> ifconfig
```

❖ **Configuration**

```
msh> ifconfig interface_name
parameter address
```

Interface name	Interface to be configured
ether	Ethernet interface *1
ip1394 *2	IEEE 1394 interface
wlan *3	IEEE 802.11b interface

*1 If you did not enter an interface name, it will automatically be set to the Ethernet interface.

*2 Available when the optional 1394 interface board is installed.

*3 You can specify an interface when installing the optional 802.11b interface kit.

Parameter	Meaning
(no parameter)	IP address
netmask	subnet mask
broadcast	broadcast address

❖ **Changing the Interface**

You can specify either Ethernet interface or IEEE 802.11b interface when using the optional 802.11b interface kit.

```
msh> ifconfig interface up
```

 **Note**

- You cannot specify the optional IEEE 1394 interface board (ip1394).

The following is a sample configuration, using an IP address of 192.168.15.16 on an Ethernet interface:

```
msh> ifconfig ether
192.168.15.16
```

The following is a sample configuration, using a subnet mask of 255.255.255.0 on an Ethernet interface:

```
msh> ifconfig ether netmask
255.255.255.0
```

 **Note**

- This affects the configuration of the network interface board on the IP address used.
- The TCP/IP setting is the same as that of the Ethernet interface and IEEE 802.11b interface.
- To enter an address using hexadecimal, prefix it with "0x".

Address

❖ Sub-net Mask

A number used to numerically “mask” or hide the IP address on the network by eliminating those parts of the address that are alike for all machines on the network.

❖ Broadcast address

A specified address for sending data to specific devices on the network.

Note

- To get the above addresses, contact your network administrator.
- If you do not know the address to configure, use the machine's default.
- The Ethernet interface and IEEE 802.11b interface share the same TCP/IP address. When changing interfaces, the former interface setting is applied to the new interface.
- When installing the optional 1394 interface board, set the subnet so it does not overlap with the Ethernet interface or the IEEE 1394 interface.

Access control

Use the “access” command to view and configure access control. You can also specify two or more access ranges.

❖ Reference

```
msh> access
```

❖ Configuration

```
msh> access ☆ range start-address end-address
```

- ☆ represents a target number between 1 and 5. (Up to five access ranges can be registered and selected.)

Example: To specify accessible IP addresses between 192.168.0.10 and 192.168.0.20:

```
msh> access 1 range 192.168.0.10 192.168.0.20
```

Note

- The access range restricts the workstations from which printing is possible by means of an address. If you do not need to restrict printing, make the setting “0.0.0.0”.
- The entry is invalid if the start address is greater than the end address.
- Up to five access ranges can be specified. The entry is invalid if the target number is omitted.
- Sessions other than those from a Web browser ^{*1} or telnet are limited by access control.

^{*1} This does not include viewing and file management with the Document Server.

❖ Access control initialization

```
msh> access flush
```

Note

- This restores the factory default so all access ranges become “0.0.0.0”.

DHCP

Use the "dhcp" command to configure the DHCP settings.

❖ Reference

The following command displays the current DHCP settings.

```
msh> dhcp
```

❖ Configuration

You can configure the DHCP settings.

```
msh> dhcp interface_name [on|off]
```

Note

- Select **[on]** to enable DHCP. Select **[off]** to disable DHCP.

❖ Interface Priority Configuration

You can assign priorities governing which interface obtains DHCP parameters.

```
msh> dhcp priority interface_name
```

Note

- Priority assignment is useful when connecting more than one interface to the machine.
- If an interface is not selected, it appears according to the currently set priority regardless of multiple interface connections.

Interface name	Interface to be configured
ether	Ethernet interface
wlan ^{*1}	IEEE 802.11b interface
ip1394 ^{*2}	IEEE 1394 interface

^{*1} Available when the optional 802.11b interface kit is installed.

^{*2} Available when the optional 1394 interface board is installed.

Reference

For more information about DHCP, see p.104 "Using DHCP".

Protocol

Use the "set" command to allow or prevent remote access for each protocol.

```
msh> set protocol {up | down}
```

Protocol	
tcpip	"up" means active and "down" means inactive.
appletalk	
netware	
smb	
scsiprint ^{*1}	
ip1394 ^{*1}	
lpr	
ftp	
rsh	
diprint	
web	
snmp	
ipp	
http	

^{*1} Available when the 1394 interface board is installed.

Note

- If you prohibit remote access via TCP/IP and then log out, you cannot use remote access. If you did this by mistake, you can use the control panel to allow access by TCP/IP.
- When you prevent access via TCP/IP, you are also prevented from using ip1394, lpr, ftp, rsh, diprint, web, snmp, ipp, and http.

❖ Display

The following command displays current tcpip, appletalk, netware, and smb settings.

```
msh> set protocol
```

Printer status

The following command can be used to get information about the current printer status:

msh> command

Command	Information that is displayed
status	Status of printer. Information about print jobs.
info	Information about the paper tray, output tray, printer language of printer.
prnlog [ID]	Lists the last 50 print jobs.

Note

- ❑ For more information about print jobs is displayed when the ID number is added after the prnlog command.

Reference

For more information about the meaning of the data returned using these commands, see p.110 "Understanding Displayed Information".

Network interface board configuration settings information

Use the "show" command to display the network interface board configuration settings.

msh> show [-p]

Note

- ❑ Add "-p" (as above) to have the information displayed one screen at a time.

Reference

For more information about the meaning of the data returned using this command, see p.116 "Configuring the Network Interface Board".

System log information

Use the "syslog" command to display information stored in the system log.

msh> syslog

Reference

For more information about the displayed information, see p.120 "System Log Information".

SNMP

Use the "snmp" command to display and edit SNMP configuration settings such as the community name.

Limitation

- ❑ The 1394 interface board supports TCP/IP only.

Note

- ❑ You can configure one of ten SNMP access settings numbered 1-10.
- ❑ If you change the community name, you must change your computer settings. See p.106 "SNMP".
- ❑ Default access settings 1 and 2 are as follows:

Number	1	2
Community name	public	admin
IP address	0.0.0.0	0.0.0.0
Access type	read-only trap off	read-write trap off

❖ **Display**

Shows SNMP information and available protocols.

```
msh> snmp ?
```

The following command displays the settings of registered number specified.

```
msh> snmp [registered_number]
```

Omitting the number displays all access settings.

```
msh> snmp [-p]
```

 **Note**

- Add “-p” (as above) to have the information displayed one screen at a time.

❖ **Community name configuration**

You can set the community name of the registered number.

```
msh> snmp number name community_name
```

 **Note**

- The community name can consist of up to 15 characters.

❖ **Access type configuration**

You can select the access type from those listed below:

```
msh> snmp number type access_type
```

Access type	Type of access permitted
read	Read only
write	Read and write
trap	User notified of trap messages.
no	All access denied.

❖ **Protocol configuration**

You should use the following command to set protocols to active or inactive. If you set a protocol to inactive, all access settings for that protocol will be disabled:

```
msh> snmp {ip | ipx} {on | off}
```

- “on” means active, “off” means inactive.

To change an access setting protocol, use the following command. However, if you have disabled a protocol using the above command, making it active here will have no effect.

```
msh> snmp number active {ip | ipx} {on | off}
```

❖ **Access configuration**

You can configure a host address according to protocols used.

The network interface board accepts requests only from hosts with “read-only” or “read-write” access type addresses. Enter “0” to have the network interface board accept requests from any host without requiring a specific type of access.

```
msh> snmp number {ip | ipx} address
```

 **Note**

- To specify TCP/IP protocol, enter “ip” followed by a space, and then the IP address.
- To specify the IPX/SPX protocol, enter “ipx” followed by a space, and then the IPX address followed by a decimal, and then the MAC address of the network interface board.

The following is a sample configuration using the registration number 3 with the IP address 192.168.15.16:

```
msh> snmp 3 ip 192.168.15.16
```

The following is a sample configuration using the registration number 3 with the IPX address 7390A448, and the MAC address 00:00:74:62:5C:65:

```
msh> snmp 3 ipx 7390A448:
000074625C65
```

IPP

Use the "ipp" command to configure IPP settings.

❖ Viewing setting

The following command displays the current IPP setting:

```
msh> ipp
Example output:
timeout=900(sec)
auth off
```

- The "timeout" setting specifies how many seconds the computer keeps trying to access the network printer to send print jobs if no connection can be made.
- The "auth" setting indicates the user authorization mode.

❖ IPP timeout configuration

Specify how many seconds to wait before canceling a print job if it has been interrupted for some reason. The time can be from 30 to 65535 seconds.

```
msh> ipp timeout {30 - 65535}
```

❖ IPP user authorization configuration

Use IPP user authorization to restrict printing with IPP to certain users. The default is "off".

```
msh> ipp auth {basic|digest|off}
```

- "basic" and "digest" are user authorization settings.
- "off" removes the user authorization.

Note

- ❑ If you select "basic" or "digest", see next section "Configuring IPP user authorization" for how to configure the user name. Up to ten user names are available.

❖ Configuring IPP user authorization

Use the following command:

```
msh> ipp user
```

The following message appears:

```
Input user number (1 to
10):
```

Enter the number, user name, and password.

```
IPP user name:user1
IPP password:*****
```

After configuring, the following message appears:

```
IPP      configuration
changed.
```

Direct printing port

The direct printing port allows printing directly from a computer, connected to the network, to the printer.

Use the "diprint" command to change direct printing port settings.

❖ View settings

The following command displays the current direct printing port settings:

```
msh> diprint
```

Example output:

```
port 9100
timeout=300(sec)
bidirect off
```

- "Port" specifies the port number of the direct printing port.
- The "bidirect" setting indicates whether the direct printing port is bidirectional or not.

❖ **Setting timeout**

You can specify the timeout interval in use when receiving data from the network.

```
msh> diprint [30~65535]
```

 **Note**

- The default is 300 seconds.
- If 0 is set, timeout is disabled.

❖ **Bidirectional configuration for the direct printing port**

Use this setting to configure whether the direct printing port is bidirectional or not. The default is "off".

```
msh> diprint bidirect {on | off}
```

 **Note**

- If you select [on], SmartNet-Monitor for Client or Standard TCP/IP on Windows 2000 might not work correctly.

SMB

Use the "smb" command to configure or delete the NetBEUI settings such as the computer name or workgroup name.

```
msh> smb parameter
```

Parameter	Settings
comp	Your computer name consisting of up to 15 characters
group	Workgroup name consisting of up to 15 characters
comment	Comment consisting of up to 31 characters
clear comp	Clears the computer name
clear group	Clears the Workgroup name
clear comment	Clears comment

 **Note**

- You cannot use a computer name starting with "RNP" or "rnp".

ROUTE

Use the "route" command to control the routing table.

This command allows you to configure and display routing information. You can change the network configuration from remote computers using this command.

 **Note**

- The maximum number of routing tables is 16.

Commands	Topics of setting
route add {host net} destination *1 gateway *1	Adds a host/network route to "destination", and a gateway address to "gateway" in the table. Host becomes the default.
route delete {host net} destination *1	Deletes a host/network route from the table. Host becomes the default.
route get {destination *1}	Displays only route information corresponding to a specified destination. When the destination is unspecified, all routing information is displayed.
route active {host net} destination *1 on/off	You can turn the specified destination on or off. Host becomes the default.
route add default gateway *1	You can set the default gateway address.
route flush	Deletes all routing information.

*1 IP address

SLP

Use the "slp" command to configure SLP settings.

You can search the NetWare server using SLP in the PureIP environment of NetWare5/5.1, 6. Use the "slp" command to configure the value of TTL used by the SLP multi-cast-packet.

Note

The default value of TTL is "1". A search is executed only within a local segment. If the router does not support multi-cast, the settings are not available even if the TTL value is increased.

The acceptable TTL value is 1 - 255.

```
msh> slp ttl {1 - 255}
```

SPRINT

Use the "sprint" command to view and configure SCSI print (SBP-2) on IEEE 1394.

Limitation

You can use this function when the optional IEEE 1394 board is installed.

❖ Viewing settings

The following command displays the current IEEE 1394 (SCSI print) settings:

```
msh> sprint
```

❖ Bidirectional configuration for IEEE 1394 (SCSI print)

```
msh> sprint bidi {on | off}
```

Use this setting to select whether IEEE 1394 (SCSI print) is bidirectional or not. The default is "on".

Setting IEEE 802.11b

Use the "wiconfig" command to configure IEEE 802.11b settings.

Limitation

You can make settings when installing the optional 802.11b interface kit.

❖ View settings

The following command displays the current IEEE 802.11b settings.

```
msh> wiconfig
```

The following command displays the IEEE 802.11b card information.

```
msh> wiconfig cardinfo
```

Note

If the IEEE 802.11b interface is not working correctly, the IEEE 802.11b card information is not displayed.

❖ Configuration

Parameter	Value to be configured
mode [ap 802.11adhoc adhoc]	You can set infrastructure mode (ap), 802.11 ad hoc mode (802.11adhoc), or ad hoc mode (adhoc). The default is 802.11 ad hoc mode.

Parameter	Value to be configured
ssid <i>ID value</i>	<p>You can set SSID in infrastructure mode.</p> <p>The characters that can be used are ASCII 0x20-0x7e (32 bytes).</p> <p>SSID value is set automatically to the nearest access point if the setting has not been made.</p> <p>If the setting has not been made for ad hoc mode, the same value as for infrastructure mode or an "AS-SID" value is automatically set.</p>
channel frequency <i>channel no.</i>	<p>You can set the channel.</p> <p>You can specify from the following channels:</p> <ul style="list-style-type: none"> • Metric Version : 1-13 • Inch Version : 1-11 <p>Set the same channel for all the machines you are using.</p>
enc [on off]	<p>You can enable or disable the WEP function. To enable the WEP function, select [on]; to disable it, select [off].</p> <p>To start the WEP function, enter the correct WEP key.</p>

Parameter	Value to be configured
key [<i>key value</i>]	<p>64-bit or 128-bit can be set.</p> <p>Only 10 hexadecimal characters can be set when using 64-bit; or 26 hexadecimal characters when using 128-bit.</p> <p>Also, set 0x as the prefix.</p> <p>To use this function, set the same WEP key for all ports that transmit to each other.</p>
auth [open shared]	<p>You can set the authorized mode when using WEP. The specified value and the authorized mode are as follows:</p> <p>open: Open system authorized (default)</p> <p>shared: Shared key authorized</p>
rate [auto 11m 5.5m 2m 1m]	<p>You can set the IEEE 802.11b transmission speed.</p> <p>The transmission speed you specify here is the speed at which data is sent. You can receive data at any speed.</p> <p>auto: automatically set (default)</p> <p>11m: 11 Mbps fixed</p> <p>5.5m: 5.5 Mbps fixed</p> <p>2m: 2 Mbps fixed</p> <p>1m: 1 Mbps fixed</p>

Note

- When changing the interface to IEEE 802.11b, see p.90 "TCP/IP address".
- When configuring the IEEE 802.11b TCP/IP, see p.90 "TCP/IP address".

Job Spool

Use the "spoolsw" command to configure Job Spool settings.

Limitation

- You can only specify LPR, IPP, and SMB protocol.

Note

- This information cannot reload automatically when you confirm Job Spool settings with the Web browser. Click **[Reload]** or **[Refresh]** on the Web browser when you want to reload this information.

Reference

The Job Spool setting appears.

```
msh> spoolsw
```

Job Spool setting

```
msh> spoolsw spool {on | off}
```

Note

- Select **[on]** to enable Job Spool or **[off]** to disable it.

Protocol configuration

To change protocol settings, use the following command. You can specify the setting for "lpr", "ipp" or "smb".

- lpr

```
msh> spoolsw lpr {on | off}
```
- ipp

```
msh> spoolsw ipp {on | off}
```

- smb

```
msh> spoolsw smb {on | off}
```

Changing the host name

Use the "hostname" command to change the printer name.

```
msh> hostname interface_name
printer_name
```

Interface name	Interface to be configured
ether	Ethernet interface *1
wlan *2	IEEE 802.11b interface
ip1394 *3	IEEE 1394 interface

*1 If you did not enter the interface name, it will be automatically set to the Ethernet interface.

*2 Available when the optional 802.11b interface kit is installed.

*3 Available when the optional 1394 interface board is installed.

Note

- Enter the printer name using up to 15 characters.
- You cannot use a printer name starting with "RNP" or "rnp".
- The Ethernet interface and IEEE 802.11b interface will have the same printer name.

WINS

Use the "wins" command to configure WINS server settings.

Viewing setting

The following command displays the WINS server IP address:

```
msh> wins
```

Example output:

```
msh> wins
WINS Configuration:
interface_name:
  WINS: On
      primary server
0.0.0.0 secondary server
0.0.0.0
      ScopeID
Current configura-
tion:
      primary server
0.0.0.0 secondary server
0.0.0.0
      hostname host_name
ScopeID
```

 **Note**

- If the IP address obtained from DHCP differs from the WINS IP address, the DHCP address is the valid address.

❖ **Configuration**

Use the "set" command to make WINS active or inactive.

```
msh> wins interface_name
{on | off}
```

- "on" means active; "off" means inactive.

❖ **Setting WINS Server Address**

You can make settings for the WINS server address.

```
msh> wins interface_name
{primary | secondary}
IP_address
```

- "primary" is for setting the primary WINS server address.
- "secondary" is for setting the secondary WINS server address.

❖ **NBT scope ID setting**

You can configure the NBT scope ID.

 **Limitation**

- Enter a scope ID using up to 31 alphanumeric characters.

```
msh> wins interface_name
scope scope ID
```

 **Note**

- If you receive different scope IDs from DHCP and WINS, the scope ID from DHCP takes priority.

Interface name	Interface to be configured
ether	Ethernet interface
wlan *1	IEEE 802.11b interface
ip1394 *2	IEEE 1394 interface

*1 Available when the optional 802.11b interface kit is installed.

*2 Available when the optional 1394 interface board is installed.

AutoNet

Use the "autonet" command to configure AutoNet settings.

❖ **Display**

The following command displays the current AutoNet settings.

```
msh> autonet
```

❖ **Configuration**

You can configure the AutoNet settings.

```
msh> autonet interface_name
[on|off]
```

 **Note**

- Select [on] to enable AutoNet.
- Select [off] to disable AutoNet.

❖ **Interface Priority Configuration**

You can assign priorities governing which interface obtains AutoNet parameters.

```
msh> autonet priority
interface_name
```

Note

- Priority assignment is useful when connecting more than one interface to the machine.
- If an interface is not selected, the interface appears according to the currently set priority, regardless of multiple interface connections.

Interface name	Interface to be configured
ether	Ethernet interface
wlan ^{*1}	IEEE 802.11b interface
ip1394 ^{*2}	IEEE 1394 interface

^{*1} Available when the optional 802.11b interface kit is installed.

^{*2} Available when the optional 1394 interface board is installed.

Reference

For more information about AutoNet, see p.105 "Using AutoNet".

Changing the password

Use the "passwd" command to change the remote maintenance password.

Important

- Be sure not to forget or lose the password.

Note

- The default password is "password".

1 Enter "passwd".

```
msh> passwd
```

2 Enter the current password.

Old password:

3 Enter the new password.

New password:

Note

- The password must consist of three to eight alphanumeric characters and symbols. Passwords are case-sensitive. For example, "R" is different from "r".
- The password is the same as that used in configuring the network interface board with a Web browser and that used in NIB Setup Tool. If you change a password from telnet, the other passwords are also changed.

4 Enter the new password again.

Retype new password:

DNS

Use the "dns" command to configure or display DNS (Domain Name System) settings.

❖ View setting

The following command displays current DNS settings:

```
msh> dns
```

❖ Using the DNS server obtained from the DHCP server

The following command enables/disables use the DNS server obtained from the DHCP server:

```
msh> dns dhcp {valid | invalid}
```

- If you use the DNS server obtained from the DHCP server, select "valid". If not, select "invalid".

If you set "valid", the DNS server from the DHCP server is prioritized.

❖ **DNS server configuration**

The following command enables/disables use of the DNS server address:

```
msh> dns number server /
server address
```

The following is a sample configuration using an IP address of 192.168.15.16 on DNS 1 server:

```
msh> dns 1 server
192.168.15.16
```

- You can register up to three DNS server numbers.
- You cannot use "255.255.255.255" as the DNS server address.

Domain name

Use the "domainname" command to display or configure domain name settings.

You can configure the Ethernet interface, IEEE 1394 interface, or IEEE 802.11b interface.

❖ **View setting**

The following command displays the current domain name:

```
msh> domainname
```

❖ **Interface domain configuration**

The following command displays or sets the Ethernet interface domain name, IEEE 1394 interface, or IEEE 802.11b interface.

```
msh> domainname /
interface_name
```

The following is a sample configuration using a domain name on the Ethernet interface:

```
msh> domainname ether
```

Interface	Interface that can be set
ether	Ethernet interface
ip1394 ^{*1}	IEEE 1394 interface
wlan ^{*2}	IEEE 802.11b interface

^{*1} Available when the optional 1394 interface board is installed.

^{*2} Available when the optional 802.11b interface kit is installed.

 **Note**

- ❑ A domain name can consist of up to 63 alphanumeric characters.

 **Setting Protocols**

The protocols described in this section provide various functions that can be used on the machine.

 **Important**

- ❑ If a protocol is disabled or inactive, functions provided by that protocol cannot be used.

 **Reference**

For more information about setting protocols, consult your network administrator.

❖ **TCP/IP**

- Functions using ftp, lpr, rsh/rcp, diprint, http, ipp, web, wins, ip1394, snmp ^{*1}, or smb ^{*2}
 - ^{*1} SNMP session using TCP/IP
 - ^{*2} SMB session using TCP/IP

 **Note**

- ❑ You cannot switch between protocols, but turning off or disabling TCP/IP will also disable smtp and dns.

❖ **AppleTalk**

- Printer function using AppleTalk under Macintosh

 **Note**

- This can be configured when a module supporting PostScript 3 is installed in the machine.

❖ **NetWare**

- Printer function using NetWare server

 **Note**

- In a PureIP environment, you can use only the print server even if this protocol has been turned off or disabled.
- Turning off or disabling NetWare will also disable the SNMP session using IPX/SPX.

❖ **SMB**

- Printer function using SmartNetMonitor for Client
- Printer function using Microsoft Windows Network

❖ **SCSI print**

- Printer function using the IEEE 1394 interface (SCSI print)

❖ **IP1394**

- Printer function using the IEEE 1394 interface (IP over 1394)

❖ **LPR**

- Printer function using standard TCP/IP
- Printer function using the command line

❖ **FTP**

- Printer function using the command line

- Scanner function using the delivery server
- Function to obtain device information using the command line

❖ **RSH/RCP**

- Printer function using the command line
- Scanner function using the Network TWAIN Driver
- Function to obtain device information using the command line

❖ **DIPRINT**

- Printer function using SmartNetMonitor for Client

❖ **WEB**

- Web browser function

❖ **SNMP**

- Bidirectional communication function using a printer driver
- Function to obtain device information using SmartNetMonitor for Client/Admin

❖ **IPP**

- Printer function using SmartNetMonitor for Client

❖ **HTTP**

- Web browser function
- Printer function using SmartNetMonitor for Client
- Function to obtain device information using SmartNetMonitor for Client/Admin

 **Note**

- Turning off or disabling http will also disable ipp and web.

.....

Using DHCP

You can use the printer in a DHCP environment. You can also register the printer NetBIOS name on a WINS server when it is running.

If you connect an Ethernet interface and IEEE 1394 (IP over 1394) interface simultaneously, pay attention to the following:

❖ When a static IP address is set for both interfaces

- IP Address: If interface IP addresses overlap, the Ethernet interface is selected.
- Subnet Mask: If interface subnet masks overlap, the Ethernet interface is selected.
- Gateway Address: The selected value is applied.

Note

- Make the gateway address setting inside the subnet set in the interface.
- If a value is beyond the range of the subnet selected by the interface, the machine operates using "0.0.0.0".

❖ When obtaining addresses from the DHCP server

- IP Address, Subnet Mask: you can configure addresses assigned by a DHCP server.

Note

- If IP addresses overlap or the same subnet IP addresses are selected, the effective value is assigned only to the prioritized interface.
- Ethernet has default interface priority.

- AutoNet: A temporary IP address starting with 169.254 and not used on the network, is assigned to the prioritized interface.

Note

- Default interface priority is IEEE 1394 (IP over 1394).
- Gateway Address, DNS Server Address, and Domain Name: You can configure the addresses assigned by DHCP to the prioritized interface.
If the gateway address is beyond the range of the subnet selected for the interface, the machine operates using "0.0.0.0".

Note

- Ethernet has default interface priority.

❖ When there are static IP addresses and addresses assigned by DHCP

- IP Address and subnet mask: if a static IP address is the same as an address assigned by DHCP, or the static subnet mask address and the subnet mask address assigned by DHCP overlap, the machine uses the static IP address interface.

Note

- The interface with the DHCP setting is set by default.
 - Gateway Address: operates using the address entered manually.

Note

- ❑ If a static address is not selected, or is set to 0.0.0.0, the interface using the address assigned by DHCP is used.

Note

- ❑ Printers that register the printer NetBIOS name on a WINS server must be configured for the WINS server. See p.99 “WINS”.
- ❑ Supported DHCP servers are Windows NT 4.0 Server Service Pack 4 or later versions, Windows 2000, Windows XP Professional Server, and NetWare 5/5.1, 6.
- ❑ If you do not use the WINS server, reserve the printer's IP address in the DHCP server so the same IP address is assigned every time.
- ❑ To use the WINS server, change the WINS server setting to “active” using the control panel.
- ❑ Using the WINS server, you can configure the host name via the remote network printer port.
- ❑ DHCP relay-agent is not supported. If you use DHCP relay-agent on a network via ISDN, it will result in increased line charges. This is because your computer connects to the ISDN line whenever a packet is transferred from the printer.
- ❑ If there is more than one DHCP server, use the same setting for all servers. The machine operates using data from the DHCP server that responds first.

Using AutoNet

If the printer IP address is not automatically assigned by the DHCP server, a temporary IP address starting with 169.254 and not used on the network can be automatically selected by the printer.

Note

- ❑ The IP address assigned by the DHCP server is given priority over that selected by AutoNet.
- ❑ You can confirm the current IP address on the configuration page. For more information about the configuration page, see *Printer Reference 2*.
- ❑ When AutoNet is running, the NetBIOS name is not registered on the WINS server.
- ❑ The machine cannot communicate with devices that do not have the AutoNet function.

SNMP

The machine is equipped with an SNMP (Simple Network Management Protocol) agent that operates under UDP and IPX on the Ethernet/wireless LAN interface, and UDP on the IEEE 1394 (IP over 1394) interface. Using the SNMP manager you can get information about the machine.

The default community names are “public” and “admin”. You can get MIB information using these community names.

Important

- If you change the machine’s community name to one different from the default, use SNMP Setup Tool to change the setting for the computer. For more information, see SNMP Setup Tool Help.

Note

- Follow the procedure below to start SNMP Setup Tool:
 - Windows 95/98/Me, Windows 2000, Windows NT 4.0:
On the **[Start]** menu, point to **[Programs]**, point to **[SmartNetMonitor for Admin]**, and then click **[SNMP Setup Tool]**.
 - Windows XP:
On the **[Start]** menu, point to **[All Programs]**, point to **[SmartNetMonitor for Admin]**, and then click **[SNMP Setup Tool]**.

◆ Supported MIBs

- MIB-II
- PrinterMIB
- HostResourceMIB
- RicohPrivateMIB

Single-line Messages on the Display Panel

This section describes the most common network-related messages that appear on the display panel. If a message not described here appears, act according to that message.

Messages without Code Numbers

Reference

Before turning the main power off, see "Turning On the Power", *General Settings Guide*.

Message	Causes	Solutions
Ethernet board has a problem.	An error has occurred in the Ethernet board.	Turn off the main power switch, and back on again. If the message appears again, contact your sales or service representative.
IEEE1394 board has a problem.	An error has occurred in the IEEE 1394 board.	
Problems with IEEE1394 Board.	An error may have occurred in the IEEE 1394 board.	
HDD has a problem.	An error has occurred in the hard disk drive.	
IEEE 802.11b (Wireless LAN) has a problem.	An error has occurred in the IEEE 802.11b (wireless LAN) board.	Turn off the main power switch, and check the card is installed correctly. If the message appears again, contact your sales or service representative.
Cannot connect with the wireless card.	IEEE 802.11b card was not inserted when the machine was turned on, or it was pulled out after the machine turned on. An error has occurred in the IEEE 802.11b card.	
Problems with the wireless card.	An error has occurred in the IEEE 802.11b card.	
Problems with the wireless board.	An error has occurred in the IEEE 802.11b (wireless LAN) board.	Turn off the main power switch, and back on again. If the message appears again, contact your sales or service representative.

Messages with Code Numbers

Note

A message reporting an error appears on the display panel as shown.

Message	Causes	Solutions	Code numbers
Cannot connect with DHCP Server. (The DHCP server cannot be found.	Check the DHCP server is running on the network.	101
			201
			301
IP Address is already in use. :	The specified IP address overlaps another IP address.	The IP address specified for the machine overlaps another IP address in use. Check the address of the device indicated in <MAC address>.	102
			202
			302
Check the following: IP Address, Sub-net Mask and Gateway Address. (An unauthorized value is specified as the IP address or gateway address.	Change the IP address, subnet mask, or gateway address to the correct value.	103
			203
			303
The same IP Address exists on more than one interfaces.	IP addresses overlap across multiple interfaces. IP addresses of simultaneously operating interfaces overlap.	The IP address of the specified interface overlaps the IP address of another interface. Configure the IP address so it does not overlap.	004
Cannot set within the same sub-net range. (Subnet masks overlap across multiple interfaces. The subnet masks of simultaneously operating interfaces overlap.	The subnet range of the specified interface overlaps the subnet range of another interface. Configure the subnet mask so it does not overlap.	005
Cannot connect to the specified Netware server. (Cannot contact to the specified file server.	The file server is refusing the connection for some reason. Check the file server setting. See p.58 "Printing with NetWare".	106
			206

Message	Causes	Solutions	Code numbers
Cannot connect to the specified Netware print server. (Cannot contact to the specified file server in remote printer mode.	The print server is refusing the connection for some reason. Check the print server setting. See p.58 "Printing with NetWare".	107
			207
This Net-BIOS name is already in use. (The NetBIOS name overlaps.	The interface's NetBIOS name specified overlaps another interface's NetBIOS name. Configure the NetBIOS name so that it does not overlap.	108
			208
			308

❖ Code Numbers

The problem interface is displayed.

- 1XX: Ethernet
- 2XX: IEEE 802.11b
- 3XX: IEEE 1394
- 0XX: Independent of interface

❖ Order of priority of messages (when multiple errors occur)

Order of interface priority

- 1.Ethernet
- 2.IEEE 802.11b
- 3.IEEE 1394

Order of protocol priority

- 1.TCP/IP
- 2.NetWare
- 3.NetBEUI
- 4.AppleTalk

Note

- When messages for the same protocol appear, they are displayed ascending in code order.

Understanding Displayed Information

This section describes how to read the status information returned by the network interface board.

Print Job Information

Print job status can be viewed using the following commands:

- telnet : Use the "status" command. See p.93 "Printer status".

Item name	Meaning
Rank	Print job status: <ul style="list-style-type: none"> • Active Printing or preparing for printing • Waiting Waiting to be transferred to the printer
Owner	Print request user name
Job	Print request number
Files	The name of the document
Total Size	The size of the data (spooled) The default is "0 bytes".

Print Log Information

This is a record of the most recent 50 jobs printed.

This log can be displayed with the following commands:

- telnet : Use the "prnlog" command. See p.93 "Printer status".

Name	Meaning
ID	Print request ID
User	Print request user name
Page	The number of pages printed
Result	The result of the print request
Time	The time the print request was received
UserID ^{*1}	User ID is to be configured using the printer driver
JobName ^{*1}	The name of the document for printing

^{*1} Displays UserID and JobName information when entering the "prnlog" command using the ID.

Machine Status and Configuration

You can check the machine status and configuration using telnet or UNIX.

❖ telnet

Use the "info" or "status" command.

❖ UNIX

Use the "lpr" or "lpstat" command, or "stat", "info" parameter of rsh, rcp, or ftp.

Machine status

Status	Description
Call Service Center	Call service center and ask for assistance.
Card/Counter not inserted	The machine is waiting for prepaid card or key counter to be inserted.
Coin/Key Counter not inserted	The machine is waiting for coin or key counter to be inserted.
Coin or amount not inserted	The machine is waiting for coin to be inserted.
Cover Open: Bridge Unit center	Bridge unit center cover is open.
Cover Open: Bridge Unit Left	Bridge unit left cover is open.
Cover Open: Bridge Unit Right	Bridge unit right cover is open.
Cover Open: Finisher	Finisher cover is open.
Cover Open: Finisher Front lower	Finisher lower-front cover is open.
Cover Open: Finisher Lower Left	Finisher lower-left cover is open.
Cover Open: Finisher Upper	Finisher top cover is open.
Cover Open: Front Cover	The machine's front cover is open.
Cover Open: Lower Right Cover	The machine's lower-right cover is open.
Cover Open: Right Cover	The machine's center-right cover is open.
Cover Open: Upper Right Cover	The machine's upper-right cover is open.
Empty: Toner	Toner has run out.
Energy Saver Mode	The machine is standing by in Energy Saver mode.
Error: Duplex Unit	Duplex unit is not installed correctly.
Error: Ethernet Board	An Ethernet board error has occurred.
Error: HDD Board	A hard disk drive board error has occurred.
Error: IEEE1394 Board	An IEEE 1394 board error has occurred.
Error: Memory Switch	Memory switch data is corrupt.

Status	Description
Error: Memory Value	A memory error has occurred.
Error: Parallel I/F Board	A parallel interface board error has occurred.
Error: USB Interface	A USB interface board error has occurred.
Error: Wireless Card	Wireless card is not inserted.
Error: Wireless Card or Board	A wireless card or wireless board error has occurred.
Full: Finisher	Finisher tray is full.
Full: Finisher Booklet Tray	Booklet finisher tray is full.
Full: Hole Punch Receptacle	Chad receptacle for hole punch is full.
Full: Internal Tray 1	Internal tray 1 is full.
Full: Internal Tray 2	Internal tray 2 is full.
Full: Waste Toner	Waste toner container is full.
In Use: Finisher	Finishing is in progress.
In Use: Input Tray	Paper tray is in use.
In Use: Staple Unit	Stapling is in progress.
Key Card not inserted	The machine is waiting for key card to be inserted.
Key Card/Counter not inserted	The machine is waiting for key card or key counter to be inserted.
Key Counter not inserted	The machine is waiting for key counter to be inserted.
Low: Toner	Toner has almost run out.
Malfunction: Duplex Unit	There is a problem with the duplex unit.
Malfunction: Ext. Charge Unit	There is a problem with the external charge unit.
Malfunction: LargeCapacity Tray	There is a problem with the LCT.
Malfunction: Output Tray	There is a problem with the output tray.
Malfunction: Staple Unit	There is a problem with the stapler.
Malfunction: Tray 1	There is a problem with tray 1.
Malfunction: Tray 2	There is a problem with tray 2.
Malfunction: Tray 3	There is a problem with tray 3.
Malfunction: Tray 4	There is a problem with tray 4.
Mismatch: Paper Size	Indicated paper tray does not contain paper of selected size.
Mismatch: Paper Size and Type	Indicated paper tray does not contain paper of selected size and type.

Status	Description
Mismatch: Paper Type	Indicated paper tray does not contain paper of selected type. Auto Paper Select cannot detect selected paper size and type.
Nearly Full: Waste Toner	Waste toner container is nearly full.
Need more Booklet Staples	Booklet stapler has almost run out of staples.
Need more Staples	Stapler has almost run out of staples.
No Paper: Selected Tray	Selected tray has run out of paper.
Not Detected: Selected Tray	Selected tray is not attached or is not attached correctly.
Not Detected: Finisher rt. Guide	Finisher guide is not attached correctly.
Panel Off Mode	The machine is in Panel-Off mode.
Paper in Duplex Unit	Duplex unit cannot be used because there is paper left in it.
Paper in Finisher	Finisher cannot be used because there is paper left in it.
Paper Misfeed: Duplex Unit	Paper has jammed in duplex unit.
Paper Misfeed: Finisher	Paper has jammed in finisher.
Paper Misfeed: Input Tray	Paper has jammed in paper feed path.
Paper Misfeed: Internal/Output	Paper has jammed in the machine or output tray delivery path.
Paper Misfeed: Output Tray	Paper has jammed in output tray.
Prepaid Card not inserted	The machine is waiting for prepaid card to be inserted.
Printing	Printing is in progress.
Ready	The machine is ready to print.
Tray Error: Chaptering	Same tray has been selected for chapter separator pages and body pages.
Tray Error: Duplex Printing	Selected paper tray cannot be used for duplex printing.
Warming Up	The machine is warming up or waiting to finish replenishing toner.

Machine configuration

Note













- "*" (asterisk) is displayed with the current setting.
- Regarding *1-*5, see table below.

Item	Description
Input Tray	
No.	ID number of the paper tray
Name	Name of the paper tray ^{*1}
Paper Size	Paper size loaded in the paper tray ^{*2}
Status	Current status of the paper tray ^{*3}
Output Tray	
No.	ID number of the output tray
Name	Name of the output tray ^{*4}
Status	Current status of the output tray ^{*5}

◆ *1 Input Tray: Name

Name	Description
Tray X	Name of installed paper tray (X is the number of tray.)
LCT	Large Capacity Tray (LCT)
Bypass Tray	Bypass tray

◆ *2 Input Tray: Paper Size

Paper size	Description
A3 (297 × 420)	A3 
B4JIS (Japanese Industrial Standard) (257 × 364)	B4 
A4 (297 × 210)	A4 
A4 (210 × 297)	A4 
B5JIS (257 × 182)	B5 
B5JIS (182 × 257)	B5 
A5 (210 × 148)	A5 
A5 (148 × 210)	A5 
A6 (105 × 148)	A6 
11 × 17	DLT 
8 ¹ / ₂ × 14	LG 
8 ¹ / ₂ × 11	LT 

Paper size	Description
11 × 8 ¹ / ₂	LT
5 ¹ / ₂ × 8 ¹ / ₂	HLT
8 ¹ / ₂ × 5 ¹ / ₂	HLT
Custom Size	Custom Size
10 ¹ / ₂ × 7 ¹ / ₄	Executive
7 ¹ / ₄ × 10 ¹ / ₂	Executive
8 ¹ / ₄ × 13	Folio
8 ¹ / ₂ × 13	Foolscap
8 × 13	8"×13"
8K (267 × 390)	8K
16K (195 × 267)	16K
16K (267 × 195)	16K

❖ *3 Input Tray: Status

Status	Description
Normal	—
Not Detected	There is no paper tray.
No Paper	There is no paper in the paper tray.

❖ *4 Output Tray: Name

Name	Description
Internal Tray 1	Internal tray 1
Internal Tray 2	Internal tray 2
External Tray	External tray
Finisher Upper Tray	Finisher upper tray (optional: Finisher)
Finisher Shift Tray	Finisher shift tray (optional: Finisher)
Finisher Shift Tray 1	Finisher shift tray 1 (optional: Finisher)
Finisher Shift Tray 2	Finisher shift tray 2 (optional: Finisher)
Finisher Booklet Tray	(optional: Booklet finisher)

❖ *5 Output Tray: Status

Status	Description
Normal	----
Paper In	There is paper in the output tray.
Full	Output tray is full of paper.
Error	Other error

Configuring the Network Interface Board

The network interface board settings can be displayed using the commands below.

- telnet : Use the "show" command. See p.93 "Network interface board configuration settings information".

Item name	Meaning
Common Mode Protocol Up/Down AppleTalk TCP/IP NetWare SMB IP over 1394 *1 SCSI print *1 Ethernet interface Syslog priority NVRAM version Device name Comment Location Contact Soft switch	“Up” means active; “Down” means inactive. Internal version number Internal version number
AppleTalk Mode Net Object Type Zone	AppleTalk protocol selected Network number Macintosh printer name The type of printer Name of zone the printer belongs to

Item name	Meaning
SMB Switch Mode Direct print Notification Workgroup name Computer name Comment Share name[1] Protocol	 (this value is fixed) (this value is fixed) Notification of print job completion Name of the workgroup Name of the computer Comment Share name (name of the printer type)
IEEE 802.11b *3 Device name DHCP Address Netmask Broadcast SSID Channel range Channel Communication mode Authentication Tx Rate WEP encryption Encryption key	 Dynamic Host Configuration Protocol IP address Subnet mask Broadcast address SSID being used Channels available for use Channel being used IEEE 802.11b interface transmission mode Validity or invalidity of the authorized mode setting when using WEP IEEE 802.11b interface speed Enable or disable WEP 64-bit WEP key / 128-bit WEP key
IP over 1394 *1 Device name DHCP Address Netmask Broadcast	 Name of the machine Dynamic Host Configuration Protocol IP address Subnet mask Broadcast address
SCSI print *1 Bidi.	 Bidirectional setting (on/off)
DNS Server [☆] *4 use DHCP parameters	 DNS server address

Item name	Meaning
Domain name ether ip1394 * ¹ wlan * ³	Ethernet interface domain name IEEE 802.11b interface domain name IEEE 1394 interface domain name
WINS ether Primary WINS Secondary WINS ip 1394 * ¹ Primary WINS Secondary WINS wlan * ³ Primary WINS Secondary WINS	Ethernet interface WINS name Primary WINS server address Secondary WINS server address IEEE 1394 interface WINS name Primary WINS server address Secondary WINS server address IEEE 802.11b interface WINS name Primary WINS server address Secondary WINS server address
Shell mode	Mode of the remote maintenance tool

*¹ You can display these item names when installing the optional 1394 interface board.

*² ☆ represents a target number between 1 and 5.

*³ You can display these item names when installing the optional 802.11b interface kit.

*⁴ ☆ represents a target number between 1 and 3.

Message List

This is a list of messages written to the machine's system log. The system log can be viewed using the "syslog" command.

System Log Information

You can use the following methods to view the system log:

- telnet : Use the "syslog" command. See p.93 "System log information".

Message	Causes and solutions
Access to NetWare server <file server name> denied. Either there is no account for this print server or the NetWare server or the password was incorrect.	(In print server mode) Cannot log on to the file server. Make sure the print server is registered on the file server. If a password is specified for the print server, delete it.
add_sess: bad trap addr:<IpAddress>, community:<community name>	The IP address (0.0.0.0) is unavailable when the community access type is TRAP. Specify the host IP address for the TRAP destination.
add_sess: community<community name> already defined.	The same community name already exists. Use another community name.
add_sess_ipx: bad trap addr: <IPX address>, community:<community name>	The IPX address (00:00:00:00:00:00) is unavailable when the community access type is TRAP. Specify the host IPX address for the TRAP destination.
add_sess_ipx: community <community name> already defined.	The community name already exists. Use another community name.
ANONYMOUS FTP LOGIN FROM <IP address>, <password>	An anonymous login has been made with a password <password> from the host <IP address>.
anpd start. (AppleTalk)	An anpd (AppleTalk Network Package Daemon) has started.
Attach FileServer =<file server name>	Attached to the file server as a nearest server
Attach to print queue <print queue name>	(In print server mode) Attached to the print queue name
Cannot create service connection	<p>If the remote printer is working: A connection with the file server cannot be established. The amount of data may have exceeded the file server's user limit.</p> <p>If the remote printer is working: The printer with the required <printer number> does not appear in <print server name>. Check the printer number of the printer registered in the print server.</p>

Message	Causes and solutions
Cannot find rprinter(<print server name>/<printer number>)	Check the printer number registered in the print server.
Change IP address from DHCP Server.	The IP address changes when DHCP LEASE is renewed. To always assign the same IP address, set a static IP address to the DHCP server.
child process exec error! (process name)	The network service failed to start. Turn the printer off and then on. If this does not work, contact your service or sales representatives.
Connected DHCP Server(<DHCP server address>).	The IP address was successfully received from the DHCP server.
connection from <IP address>	Logged on from the host <IP address>
Could not attach to PServer <print server name>	When using a remote printer: Cannot connect to the print server. The print server is rejecting the connection for some reason. Check the print server settings.
Could not attach to FileServer <error code>	When using a remote printer: Cannot connect to the file server. The file server is rejecting the connection for some reason. Check the file server settings.
Current Interface Speed:xxxMbps	The speed of the network (10 Mbps or 100 Mbps)
Current IP address <current IP address>	The IP address <current IP address> was received from the DHCP server.
Current IPX address<IPX address>	The current IPX address
DHCP lease time expired.	DHCP lease time has expired. The printer tries to locate the DHCP server again. The IP address used till now becomes invalid.
DHCP server not found.	The DHCP server cannot be found. Make sure the DHCP server is running on the network.
dhcpcd start.	A dhcpcd (DHCP client server) has started.
Duplicate IP=<IP address>(from <MAC address>).	The same IP address is used. Every IP address must be unique. Check the address of the device indicated in <MAC address>.
Established SPX Connection with PServer, (RPSocket=<socket number>, connID=<connection ID>)	(In remote printer mode) A connection with the print server has been established.
exiting	lpd service has ended and the system is closing down.
Exit pserver	(In print server mode) Exits the print server because necessary print server settings have not been made.

Message	Causes and solutions
Frametype =<frame type name>	The <frame type name> is configured to be used on NetWare.
httpd start.	httpd has started.
IEEE 802.11b <Transmission mode> mode	<p>Transmission mode for IEEE 802.11b (Example: current mode is infrastructure mode.)</p> <p>IEEE 802.11b [infrastructure] mode (Example: current mode is 802.11 ad hoc mode.)</p> <p>IEEE 802.11b [802.11 ad hoc] mode (Example: current mode is ad hoc mode.)</p> <p>IEEE 802.11b [ad hoc] mode</p>
IEEE 802.11b current channel <Channel>	<p>The current channel is displayed.</p> <p>The value selected by the user is displayed in ad hoc mode.</p> <p>The channel used in the access point is displayed in infrastructure mode. (Example: current channel is 11.)</p> <p>IEEE 802.11b current channel 11</p>
IEEE 802.11b Card Firmware REV. <Version>	<p>Wireless LAN Card Firmware version (Example: current version is 0.8.3.)</p> <p>IEEE 802.11b Card Firmware REV. 0.8.3</p>
IEEE 802.11b MAC Address = <MAC Address>	<p>The IEEE 802.11b I/F MAC address is displayed.</p> <p>(Example: current MAC address is 00:00:74:XX:XX:XX.)</p> <p>IEEE 802.11b MAC Address = 00:00:74:XX:XX:XX</p>
IEEE 802.11b SSID <ssid> (AP MAC Address <MAC Address>)	<p>The access point SSID used in infrastructure mode and the MAC address of the access point are displayed.</p> <p>(Example: current MAC address is xx:xx:xx:xx:xx:xx and SSID value is "test-ssid".)</p> <p>IEEE 802.11b SSID test-ssid (AP MAC Address xx:xx:xx:xx:xx:xx)</p>
IEEE 802.11b Tx Rate <Transfer Speed>	<p>The IEEE 802.11b transmitting speed (set speed) is displayed.</p> <p>(Example: current Tx Rate is 11 Mbps.)</p> <p>IEEE 802.11b Tx Rate 11 Mbps</p> <p>Transmission speeds vary depending on signal quality. Displayed values may differ from actual transmission speed.</p>

Message	Causes and solutions
inetd start.	An inetd has started.
<interface> started with IP: <IP address>	<IP address> has been set for <Interface> and <Interface> started.
<Interface>: Subnet overlap.	Subnet from Netmask and the IP address you tried to set for <Interface> overlap the subnet of another interface. Set Subnet so it does not overlap with another interface.
IPP cancel-job: permission denied.	The printer could not authenticate the name of the user attempting to cancel a job.
ipp disable.	Printing with ipp is disabled.
ipp enable.	Printing with ipp is enabled.
IPP job canceled. jobid=%d.	The spooled job has been canceled due to error or user request.
job canceled. jobid=%d.	The spooled job has been canceled due to error or user request.
LeaseTime=<lease time>(sec), Renew-Time=<renew time>(sec).	The resource lease time received from the DHCP server is <lease time> in seconds. The renewal time is also <renew time> in seconds.
Login to fileserver <file server name> (<IPX IP>,<NDS BINDERY>)	(In print server mode) Logged on to the file server with NDS or BINDERY mode.
multid start.	Data transmission service for multiprotocols has started.
Name registration failed. name=<NetBIOS name>	The printer could not register the name of NetBIOS.
Name registration success in Broadcast name=<NetBIOS name>	The NetBIOS name was successfully registered from a broadcast.
Name registration success. WINS Server=<WINS Server Address> NetBIOS Name=<NetBIOS name>	The NetBIOS name was successfully registered to the WINS server.
nbstart start.(NetBEUI)	The server for setting the NetBEUI protocol stack has started.
nbttd start.	nbttd (NetBIOS over TCP/IP Daemon) has started. (Available only in DHCP mode)
NetBEUI Computer Name =<computer name>	The NetBEUI Computer Name is defined as <computer name>.
nmsd start. (NetBEUI)	nmsd (Name Server Daemon) has started.
nprinter start. (NetWare)	(In remote printer mode) NetWare service has started.
nwstart start. (NetWare)	The service for NetWare protocol stack setting has started.

Message	Causes and solutions
Open log file <file name>	(In print server mode) The specified log file has been opened.
pppd start. (AppleTalk)	AppleTalk print service has started.
permission denied.	Job cancellation was determined to be unauthorized after checking the user name and host address (except for ROOT authorization).
phy release file open failed.	A replacement network interface board is required. Contact your sales or service representatives.
Print queue <print queue name> cannot be serviced by printer 0, <print server name>	(In print server mode) The print queue name cannot be serviced. Make sure that print queue volume is on the specified file server.
Print server <print server name> has no printer.	(In print server mode) The printer is not assigned to the print server <print server name>. Using NWadmin, assign the printer, and then restart the printer device.
Print sessions full	Cannot accept the print session.
Printer <printer name> has no queue.	(In print server mode) The print queue is not assigned to the printer. Using NWadmin, assign the print queue to the printer, and then restart it.
pserver start. (NetWare)	(In print server mode) NetWare service has started.
Required computer name (<Computer name>) is duplicated name.	The same computer name is detected on the network. The start job determines the computer name by adding it to the suffix (0,1,...). Configure a new computer name that is unique.
Required file server (<file server name>) not found	Cannot find the required file server.
restarted.	LPD has started.
sap enable, saptype=<SAP type>, sapname=<SAP name>	The SAP function has started. The SAP (SAP type and SAP name) packet is issued to advertise the service on the NetWare server SAP table.
session<community name> not defined.	The requested community name is not defined.
session_ipx<community name> not defined.	The requested community name is not defined.
Set context to <NDS context name>	A <NDS context name> has been set.
shutdown signal received. network service rebooting...	Rebooting the network service.

Message	Causes and solutions
smbd start. (NetBEUI)	An smbd (SMB (Server Message Block) service) has started.
Snmp over ip is ready.	Communication over TCP/IP via SNMP is available.
Snmp over IP over 1394 is ready.	Communication over IP over 1394 via SNMP is available.
Snmp over ipx is ready.	Communication over IPX via SNMP is available.
snmpd start.	SNMP service has started.
started.	Direct print service has started.
The print server received error <error number> during attempt to log in to the network. Access to the network was denied. Verify that the print server name and password are correct.	Cannot log on to the file server. The print server is not registered or a password is specified. Register the print server without specifying a password.
SMTPC: failed to get smtp server ip-address.	Failed to get the SMTP server IP address. This could be because: <ul style="list-style-type: none"> • The DNS server could not be found. • There is no connection to the network. • The specified DNS server could not be connected to. • Incorrect DNS server is specified. • No specified SMTP server IP address in the DNS server.
SMTPC: failed to connect smtp server. timeout.	Failed to connect the SMTP server due to timeout. This could be because: <ul style="list-style-type: none"> • The SMTP server name is incorrect. • There is no connection to the network. • The network configuration is incorrect, so there is no response from the SMTP server.
SMTPC: refused connect by smtp server.	The connection to the SMTP server is denied. This could be because: <ul style="list-style-type: none"> • Another server other than the SMTP server has been specified. • The SMTP server port number is incorrect.
SMTPC: no smtp server. connection close.	No response from the SMTP protocol. Cannot connect to the SMTP server. This could be because: <ul style="list-style-type: none"> • Another server other than the SMTP server has been specified. • The SMTP server port number is incorrect.

Message	Causes and solutions
SMTPC: failed to connect smtp server.	<p>Failed to connect the SMTP server. This could be because:</p> <ul style="list-style-type: none"> • There is no connection to the network. • The network configuration is incorrect, so there is no response from the SMTP server. • The SMTP server name is incorrect. • The specified SMTP server is incorrect. • There is no specified SMTP server IP address in the DNS server. • Another server other than the SMTP server has been specified. • The SMTP server port number is incorrect.
SMTPC: username or password wasn't correct.	<p>Failed to connect the SMTP server. This could be because:</p> <ul style="list-style-type: none"> • The specified SMTP user name is incorrect. • The specified SMTP password is incorrect. <p>Check the SMTP user name and password.</p>
WINS name registration: No response to server (WINS server address)	<p>There is no response from the server during data registration.</p> <p>Check the WINS server address is correct and WINS server is working properly.</p>
WINS name registration/refresh error code (error code)	<p>The NetBEUI name could not be registered or updated. Make sure the name is not already being used. If the name is not the problem, check that the WINS server address is correct and that the WINS server is working properly.</p>
WINS wrong scopeID	<p>The scope ID is wrong.</p> <p>Specify the correct scope ID.</p>
write error occurred. (diskfull)	<p>The hard disk became full while the spool file was being written.</p> <p>Wait until enough HDD space becomes available as printing proceeds.</p>
write error occurred. (fatal)	<p>A fatal error occurred while the spool file was being written.</p> <p>Turn the printer off and then on. If this does not work, contact your service or sales representative.</p>

❖ LDAP error messages

Note

- ❑ See the description corresponding to the error message. The number in the error message is the RFC error number.

LDAP errors appear thus:

<Status>:<LDAP error message>

- Status
 - init
Error during LDAP initialization.
 - bind
Error during LDAP binding.
 - search
Error during LDAP search.
- LDAP error message

LDAP error message	Causes and solutions
Operations error(1)	An operating error has occurred. The function is not possible in the current status.
Protocol error(2)	A protocol error has occurred.
Time limit exceeded(3)	The search could not be completed within the time allowed.
Size limit exceeded(4)	Too many hits have been returned. Check the search criteria or starting position.
Compare False(5)	Result of compare request is false.
Compare True(6)	Result of compare request is true.
Authentication method not supported(7)	The selected authentication method is not supported. Check the authentication setting.
Strong authentication required(8)	Strong authentication is required. Check the authentication setting.
Partial results and referral received(9)	Partial results and referrals have been received.
Referral(10)	Referral
Administrative limit exceeded(11)	The amount of data has exceeded the limit set by the network administrator.
Critical extension is unavailable(12)	Extended function is unavailable. Consult the network administrator.
Confidentiality required(13)	Confidentiality is required. Check the server setting. Consult the network administrator if necessary.
SASL bind in progress(14)	SASL binding is in progress.

LDAP error message	Causes and solutions
No such attribute(16)	The requested attribute does not exist. Check the attribute settings.
Undefined attribute type(17)	The specified attribute is undefined.
Inappropriate matching(18)	The match is inappropriate.
Constraint violation(19)	A constraint violation has occurred.
Type or value exists(20)	The specified attribute already exists.
Invalid syntax(21)	The syntax of the specified attribute is invalid.
No such object(32)	A matching object cannot be found.
Alias problem(33)	The alias is incorrect.
Invalid DN syntax(34)	The DN syntax is invalid. Check the settings.
Entry is a leaf(35)	Entry is a leaf.
Alias dereferencing problem(36)	Alias cannot be resolved.
Inappropriate authentication(48)	Authentication has failed. Check the authentication setting.
Invalid credentials(49)	The specified authentication credentials are invalid.
Insufficient access(50)	The user's access rights are insufficient to carry out the requested operation.
DSA is busy(51)	The DSA is busy.
DSA is unavailable(52)	No DSA is available to carry out the request. Consult the network administrator.
DSA is unwilling to perform(53)	The DSA has rejected the request.
Loop detected(54)	A loop has been detected.
Naming violation(64)	A naming violation has occurred.
Object class violation(65)	An object class violation has occurred.
Operation not allowed on nonleaf(66)	The specified operation is not allowed on a non-leaf entry.
Operation not allowed on RDN(67)	The specified operation is not allowed on RDN.
Already exists(68)	The specified entry already exists.
Cannot modify object class(69)	The specified object class cannot be modified.
Results too large(70)	Too many hits have been returned. Check the search criteria.
Operation affects multiple DSAs(71)	The operation affects multiple DSAs.
Unknown error(80)	An unknown error has occurred. Consult the network administrator.

LDAP error message	Causes and solutions
Can't contact LDAP server(81)	Cannot contact the LDAP server. Check the server is working and communicating properly.
Local error(82)	A local program error or an SASL authentication error has occurred. Consult the network administrator.
Encoding error(83)	An error occurred while encoding the message to be transmitted. Consult the network administrator.
Decoding error(84)	An error occurred while decoding the received message. Consult the network administrator.
Timed out(85)	The search could not be completed within the time allowed.
Unknown authentication method(86)	An unknown authentication method has been specified. Check the authentication setting.
Bad search filter(87)	An error has been detected in the search filter specification. Check the search criteria. If the error persists, consult the network administrator.
User cancelled operation(88)	The operation has been cancelled.
Bad parameter to an ldap routine(89)	An illegal parameter was passed to the LDAP routine. Check the settings. If the error persists, consult the network administrator.
Out of memory(90)	The machine is out of memory.
Connect error(91)	A connection with the server could not be established. Check the settings.
Not Supported(92)	The specified function is not supported.
Control not found(93)	Control is not found.
No results returned(94)	There are no results to return.
More results to return(95)	There are more results to return.
Client Loop(96)	A client loop has been detected.
Referral Limit Exceeded(97)	The amount of data has exceeded the referral limit.

When Using Windows Terminal Service/MetaFrame

Operating Environment

The following combinations of operating system and MetaFrame are supported:

- ❖ **Windows NT Server 4.0 Terminal Server Edition**
 - MetaFrame 1.8 SP3/FR1 SP3
 - MetaFrame XP 1.0 SP1/SP2/FR1
- ❖ **Windows 2000 Server /Advanced Server**
 - MetaFrame 1.8 SP3/FR1 SP3
 - MetaFrame XP 1.0 SP1/SP2/FR1/FR2

Supported Printer Drivers

- ❖ **When Windows Terminal Service is operating**
 - PCL5e
 - PCL6
 - PostScript 3

Note

- The RPCS printer driver is not supported.
- Some RPCS printer driver functions do not work if Windows Terminal Service is installed, even if it is not operating.

Limitation

The following restrictions apply in the Windows Terminal Service environment.

These restrictions are due to the way Windows Terminal Service or MetaFrame works.

- ❖ **When printing (Windows Terminal Service)**

When printing a file containing a large number of bitmap images or fonts, some images or font settings may be lost. We strongly recommend testing this function under your network environment before applying it to actual jobs.
- ❖ **When using [Auto-creating client printers] (MetaFrame)**

[Auto-creating client printers] can select a logical printer created by copying the client's local printer data to the MetaFrame server. We strongly recommend testing this function under your network environment before applying it to actual jobs.

 - The settings for optional equipment, such as the finisher or Large Capacity Tray, will not be stored in the server after the equipment is disconnected. The settings for optional items will return to default values each time the client computer logs on to the server.

- When printing a large number of bitmap images or using the server in a WAN environment over dial-up lines such as ISDN, depending on the data rate, printing may be disabled or errors may occur.
- When using MetaFrame XP 1.0 or later versions, we recommend configuring **[Client Printer bandwidth]** available from **[Citrix Management Console]**, according to the environment.
- If a printing error occurs on the server and the print job or **[Auto-creating client printers]** cannot be deleted, we recommend doing the following:
 - MetaFrame 1.8 SP3, MetaFrame XP 1.0 SP1/FR1
Configure the **[Delete unfinished print jobs]** settings in the registry. For more information, see the Readme file provided with MetaFrame.
 - MetaFrame XP 1.0 FR2
Configure the **[Delete pending print jobs at logout]** settings in **[Printer Properties Management]** of the Citrix Management Console.

❖ **When using [Printer driver replication] (MetaFrame)**

[Printer driver replication] is designed to distribute printer drivers across all servers in a server farm. We strongly recommend testing this function under your network environment before applying it to actual jobs.

- If the printer drivers are not properly copied, we recommend installing them directly onto each server.

Precautions

Please pay attention to the following when using the network interface board. When configuration is necessary, follow the appropriate procedures below.

Connecting a Dial-Up Router to a Network

When using NetWare (file server)

If the NetWare file server and printer are on opposite sides of a router, packets are sent back and forth continuously, possibly incurring communications charges. Because packet transmission is a feature of NetWare, you need to change the configuration of the router. If the network you are using does not allow you to configure the router, configure the machine instead.

❖ Configuring the router

Filter packets so they do not pass over the dial-up router.

Note

- The MAC address of the filtering printer is printed on the printer configuration page. For more information about printing a configuration page, see *Printer Reference 2*.
- For more information about configuring the printer if the router cannot be configured, see the following instructions.

Configuring the printer with NetWare

- 1** Following the setup method described earlier in this manual, configure the file server.
- 2** Set the frame type for NetWare environment.

Reference

For more information about selecting a frame type, see p.17 “Setting Up the Machine on a Network”.

Configuring the printer without NetWare

- 1** When not printing, the network interface board sends packets over the network. Set NetWare to “inactive”.

Reference

For more information about selecting a protocol, see p.17 “Setting Up the Machine on a Network”.

When Using Network Utility

If the machine is connected to a network, observe the following points when setting up the machine or changing settings:

For more details, see the operating instructions and Help for ScanRouter V2 Lite/Professional and DeskTop-Binder V2 Lite/Professional.

❖ When a dial-up router is connected in a network environment

The settings for the delivery server to be connected must be made appropriately for the machine with ScanRouter V2 Lite/Professional, Auto Document Link, or DeskTopBinder V2 Lite/Professional. In addition, set up connected devices using the I/O settings of ScanRouter V2 Administration Utility. If the network environment changes, make the necessary changes for the delivery server using the machine, the administration utility of client computers, Auto Document Link, and DeskTopBinder V2 Lite/Professional. Also, set the correct information for the connected devices using the I/O settings of ScanRouter V2 Administration Utility.

❗ Important

If the machine is set up to connect to the delivery server via a dial-up router, the router will dial and go online whenever a connection to the delivery server is made. Telephone charges may be incurred.

❖ When connected to a computer that uses dial-up access

- Do not install ScanRouter V2 Lite/Professional on a computer which uses dial-up access.
- When using ScanRouter V2 Lite/Professional, DeskTopBinder V2 Lite/Professional, Auto Document Link, or a TWAIN driver on a computer with dial-up access, a dial-up connection may be performed when connecting to the delivery server and other equipment, depending on the setup. If the

computer is set up to connect to the Internet automatically, the confirmation dialog box will not appear, and telephone charges may be incurred without your being aware of it. To prevent unnecessary connections, the computer should be set up so the confirmation dialog box always appears before establishing a connection. Do not make unnecessary connections when using the above listed software.

NetWare Printing

Form feed

You should not configure form feed on NetWare. Form feed is controlled by the printer driver on Windows. If NetWare form feed is configured, the printer might not work properly. If you want to change form feed settings, always configure them using Windows.

- Under Windows 95/98/Me, clear the **[Form feed]** check box on the **[Printer Settings]** tab in the printer properties dialog box.
- Under Windows 2000/XP, clear the **[Form feed]** check box on the **[NetWare Settings]** tab in the printer properties dialog box.
- Under Windows NT 4.0, clear the **[Form feed]** check box on the **[NetWare Settings]** tab in the printer properties dialog box.

Banner page

You should not configure a banner page on NetWare. If you want to change the banner page setting, always configure it using Windows.

- Under Windows 95/98/Me, clear the **[Enable banner]** check box on the **[Printer Settings]** tab in the printer properties dialog box.
- Under Windows 2000/XP, clear the **[Enable banner]** check box on the **[NetWare Settings]** tab in the printer properties dialog box.
- Under Windows NT 4.0, clear the **[Enable banner]** check box on the **[NetWare Settings]** tab in the printer properties dialog box.

Printing after resetting the machine

After resetting the remote printer, the connection from the print server will be cut off for about 30-40 seconds before re-connecting. Depending on the NetWare specification, print jobs may be accepted, but they will not be printed during this interval.

When using the machine as a remote printer, wait about two minutes after resetting before attempting to print.

When Using IPP with SmartNetMonitor for Client

When using IPP with SmartNetMonitor for Client, note the following:

- The network printer can only receive one print job from SmartNetMonitor for Client at a time. While the network printer is printing, another user cannot access it until the job is finished. In this case, SmartNetMonitor for Client tries to access the network printer until the retry interval expires.
- If SmartNetMonitor for Client cannot access the network printer and times out, it will stop sending the print job. In this case, you should cancel the paused status from the print queue window. SmartNetMonitor for Client will resume access to the network printer. You can delete the print job from the print queue window, but canceling a print job printed by the network printer might cause the next job sent from another user to be incorrectly printed.
- If a print job sent from SmartNetMonitor for Client is interrupted and the network printer cancels the job because something went wrong, send the print job again.
- Print jobs sent from another computer do not appear in the print queue window, regardless of protocol.
- If various users send print jobs using SmartNetMonitor for Client to network printers, the printing order might not be the same as that in which the jobs were sent.
- An IP address cannot be used for the IPP port name because the IP address is used for the SmartNetMonitor for Client port name.

When the Wireless LAN Board (optional) Is Installed

When using the wireless LAN interface on the network, note the following:

❖ When moving the machine

Detach the antennas when relocating the machine locally.

After moving the machine, reattach the antennas, ensuring that:

- The antennas are positioned clear of obstacles.
- There is 40 to 60 mm between the antennas, so that they do not touch.
- The exposure glass cover and the Auto Document Feeder (ADF) do not knock the antennas.

❖ If the network area provides poor radio environment

Where radio wave conditions are bad, the network may not function due to interrupted or failed connections. When checking the wireless LAN signal and the access point, follow the procedure below to improve the situation:

- Position the access point nearer to the machine.
- Clear the space between access point and machine of obstructions.
- Move radio wave generating appliances, such as microwaves, away from the machine and access point.

Reference

For information about how to check radio wave status, see p.15 “Checking the machine's radio wave status”.

For more information about access point radio wave conditions, refer to the access point manual.

Specifications

Interface	100BASE-TX, 10BASE-T, IEEE 1394 (IP over 1394) ^{*1} , IEEE 802.11b
Frame type	EthernetII, IEEE 802.2, IEEE 802.3, SNAP
Protocol	<ul style="list-style-type: none"> • Printer (LAN-Fax) <ul style="list-style-type: none"> TCP/IP LPR RSH RCP DIPRINT FTP IPP^{*2 *3} IPX/SPX (NetWare) AppleTalk^{*4} NetBEUI SMB^{*2 *5} • Internet Fax <ul style="list-style-type: none"> TCP/IP SMTP • Network Scanner <ul style="list-style-type: none"> TCP/IP RSH FTP SMTP SMB^{*6} • Document Server <ul style="list-style-type: none"> TCP/IP FTP HTTP • Management Function <ul style="list-style-type: none"> TCP/IP RSH RCP FTP SNMP HTTP NBT DHCP DNS
SNMP	MIB-II, PrinterMIB, HostResourceMIB, RicohPrivateMIB

^{*1} The 1394 interface board supports only TCP/IP.

^{*2} Use the SmartNetMonitor for Client port.

^{*3} To use IPP under Windows XP, use the Standard IPP port.

^{*4} This can be used when the PostScript 3 module is installed.

^{*5} Under Windows, this function can be used with TCP/IP and NetBEUI.

^{*6} SMB using NetBEUI is unavailable.

INDEX

A

Access Control, 91
access type, 94
AutoNet, 100, 105

B

Bidirectional SCSI print, 37
Broadcast address, 91

C

Channel, 37
Communication Mode, 37
community name, 94
configuration
 access type, 94
 community name, 94
 Network Interface Board configuration, 116
 Web Browser, 81

D

Delivery Option, 38
DHCP, 92, 104
dial-up router, 132
Direct Printing Port, 95
DNS, 101
DNS Configuration, 35
Domain Name, 36, 37
Domainname, 102

E

Effective Protocol, 36
Energy saver mode, 80
Ethernet Speed, 35
EtherTalk
 Macintosh, 56

F

File Transfer, 38

G

Gateway Address, 35

H

Host Name, 36, 37, 99

I

IEEE 802.11b, 97
information
 Network Interface Board configuration, 93
 print job, 110
 print log, 110
 system log, 93, 120
Interface Settings/IEEE 1394, 36
Interface Settings/IEEE 802.11b, 37
Interface Settings/Network, 34
IP Address, 34, 36
IP address, 90
IP over 1394, 36
IPP, 95, 134

J

Job Spool, 99

L

LAN Type, 35

M

Machine configuration, 111, 114
Machine status, 111
Macintosh
 EtherTalk, 56
 printer name, 57
 zone, 57
message, 120
MIB, 106

N

NBT scope ID setting, 100
Number of Scanner Recalls, 42
NW Frame Type, 35

P

password, 101
precautions, 132
printer name
 Macintosh, 57
printer status, 93

R

remote maintenance
 telnet, 89
Return to Defaults, 38
ROUTE, 96

S

Scanner Recall Interval Time, 42
SCSI print (SBP-2), 37
SLP, 97
SmartNetMonitor for Client, 134
SMB, 96
SMTP Server, 39
SNMP, 93, 106
specifications, 136
SPRINT, 97
SSID Setting, 37
subnet mask, 91
system Log, 120
system log
 information, 93

T

Telnet, 111
telnet
 remote maintenance, 89
 using, 89
Transmission Speed, 38

U

UNIX, 111

W

Web Browser, 81
WEP (Encryption) Setting, 38
WINS, 99
Wireless LAN Signal, 38

Z

zone
 Macintosh, 57

4035e/4045e
D5m635/D5m645
LD135/LD145
Aficio™ 2035e/2045e

Operating Instructions
Copy Reference



-
- 1** Placing Originals
 - 2** Copying
 - 3** Troubleshooting
 - 4** User Tools (Copier/Document Server Features)
 - 5** Specifications

Type for DSm635/LD135/Aficio 2035e

Type for DSm645/LD145/Aficio 2045e

Printed in China

AE  B138-6608

Introduction

This manual describes detailed instructions on the operation and notes about the use of this machine. To get maximum versatility from this machine all operators are requested to read this manual carefully and follow the instructions. Please keep this manual in a handy place near the machine.

Important

Contents of this manual are subject to change without prior notice. In no event will the company be liable for direct, indirect, special, incidental, or consequential damages as a result of handling or operating the machine.



Notes

Some illustrations in this manual might be slightly different from the machine.

Certain options might not be available in some countries. For details, please contact your local dealer.



Warning:

Use of controls or adjustment or performance of procedures other than those specified in this manual might result in hazardous radiation exposure.

Notes:

The model names of the machines do not appear in the following pages. Check the type of your machine before reading this manual. (For details, see p.2 "Machine Types".)

- Type 1: DSm635/LD135/Aficio 2035e
- Type 2: DSm645/LD145/Aficio 2045e

Certain types might not be available in some countries. For details, please contact your local dealer.

Two kinds of size notation are employed in this manual. With this machine refer to the metric version.

For good copy quality, the supplier recommends that you use genuine toner from the supplier.

The supplier shall not be responsible for any damage or expense that might result from the use of parts other than genuine parts from the supplier with your office products.

Power Source

220 - 240V, 50/60Hz, 8A or more

Please be sure to connect the power cord to a power source as above. For details about power source, see "Power Connection" in the General Settings Guide.

In accordance with IEC 60417, this machine uses the following symbols for the main power switch:

I means **POWER ON.**

⏻ means **STAND BY.**

Trademark

Acrobat® is a registered trademark of Adobe Systems Incorporated.

Other product names used herein are for identification purposes only and might be trademarks of their respective companies. We disclaim any and all rights in those marks.

Manuals for This Machine

The following manuals describe the operational procedures of this machine. For particular functions, see the relevant parts of the manual.

Note

- r Manuals provided are specific to machine type.
- r Adobe Acrobat Reader is necessary to view the manuals as a PDF file.
- r Two CD-ROMs are provided:
 - CD-ROM 1 "Operating Instructions for Printer/Scanner"
 - CD-ROM 2 "Scanner Driver & Document Management Utilities"

v **General Settings Guide**

Provides an overview of the machine and describes System Settings (paper trays, Key Operator Tools, etc.), Document Server functions, and troubleshooting.

Refer to this manual for Address Book procedures such as registering fax numbers, e-mail addresses, and user codes.

v **Network Guide (PDF file - CD-ROM1)**

Describes procedures for configuring the machine and computers in a network environment.

v **Copy Reference (this manual)**

Describes operations, functions, and troubleshooting for the machine's copier function.

v **Facsimile Reference <Basic Features>**

Describes operations, functions, and troubleshooting for the machine's facsimile function.

v **Facsimile Reference <Advanced Features>**

Describes advanced functions and settings for key operators.

v **Printer Reference 1**

Describes system settings and operations for the machine's printer function.

v **Printer Reference 2 (PDF file - CD-ROM1)**

Describes operations, functions, and troubleshooting for the machine's printer function.

v **Scanner Reference (PDF file - CD-ROM1)**

Describes operations, functions, and troubleshooting for the machine's scanner function.

v **Manuals for DeskTopBinder V2 Lite**

DeskTopBinder V2 Lite is a utility included on the CD-ROM labeled "Scanner Driver & Document Management Utilities".

- DeskTopBinder V2 Lite Setup Guide (PDF file - CD-ROM2)
Describes installation of, and the operating environment for DeskTopBinder V2 Lite in detail. This guide can be displayed from the **[Setup]** dialog box when DeskTopBinder V2 Lite is installed.
- DeskTopBinder V2 Lite Introduction Guide (PDF file - CD-ROM2)
Describes operations of DeskTopBinder V2 Lite and provides an overview of its functions. This guide is added to the **[Start]** menu when DeskTopBinder V2 Lite is installed.
- Auto Document Link Guide (PDF file - CD-ROM2)
Describes operations and functions of Auto Document Link installed with DeskTopBinder V2 Lite. This guide is added to the **[Start]** menu when DeskTopBinder V2 Lite is installed.

v **Manuals for ScanRouter V2 Lite**

ScanRouter V2 Lite is a utility included on the CD-ROM labeled "Scanner Driver & Document Management Utilities".

- ScanRouter V2 Lite Setup Guide (PDF file - CD-ROM2)
Describes installation of, settings, and the operating environment for ScanRouter V2 Lite in detail. This guide can be displayed from the **[Setup]** dialog box when ScanRouter V2 Lite is installed.
- ScanRouter V2 Lite Management Guide (PDF file - CD-ROM2)
Describes delivery server management and operations, and provides an overview of ScanRouter V2 Lite functions. This guide is added to the **[Start]** menu when ScanRouter V2 Lite is installed.

v **Other manuals**

- PS3 Supplement (PDF file - CD-ROM1)
- Unix Supplement (Available from an authorized dealer, or as a PDF file on our Web site.)

What You Can Do with This Machine

Types of Duplex Copies

- 1-sided 2 Pages → 2-sided 1 Page (see p.43
" ❖ 1 Sided → 2 Sided")

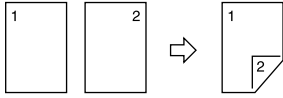

- 2-sided 1 Page → 2-sided 1 Page (see p.43
" ❖ 2 Sided → 2 Sided")

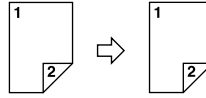

- 1-sided 4 Pages → 2-sided 1 Page (see p.47
" ❖ 1 Sided 4 Pages → Combine 2 Side")

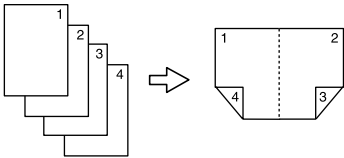

- 2-sided 2 Pages → 2-sided 1 Page (see p.47
" ❖ 2 Sided 4 Pages → Combine 2 Side")

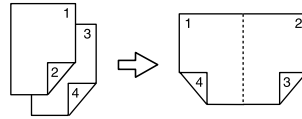

- 1-sided 8 Pages → 2-sided 1 Page (see p.47
" ❖ 1 Sided 8 Pages → Combine 2 Side")

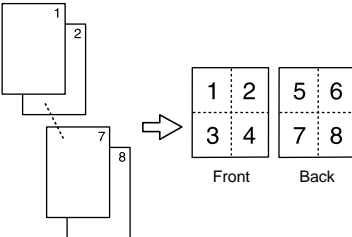

- 2-sided 4 Pages → 2-sided 1 Page (see p.47
" ❖ 2 Sided 8 Pages → Combine 2 Side")

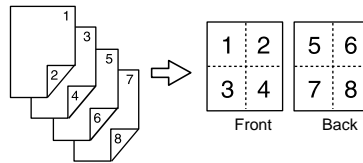

- 1-sided 16 Pages → 2-sided 1 Page (see p.47
" ❖ 1 Sided 16 Pages → Combine 2 Side")

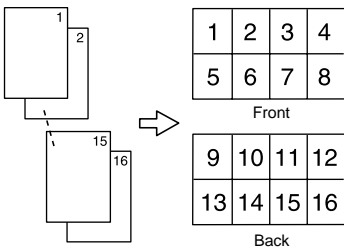

- 2-sided 8 Pages → 2-sided 1 Page (see p.48
" ❖ 2 Sided 16 Pages → Combine 2 Side")

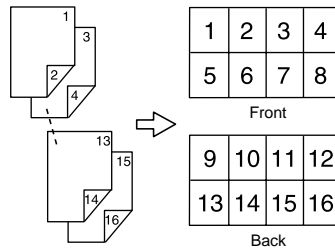

- Bound Originals → 2-sided Pages (see p.49
" ❖ Book → 2 Sided")

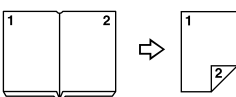

- Front/Back Bound Originals → 2-sided Pages (see p.49
" ❖ Front & Back → 2 Sided")

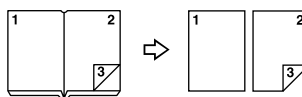

Copying Book Originals

1-sided 4 Pages → Booklet (see p.50 "❖ 1 Sided → Booklet")

Open to Left

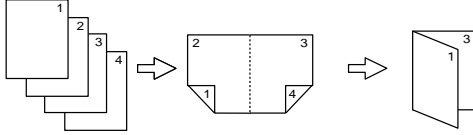

Open to Right

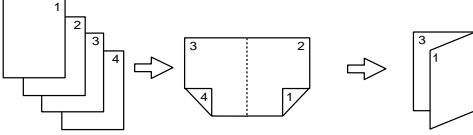

2-sided 2 Pages → Booklet (see p.50 "❖ 2 Sided → Booklet")

Open to Left

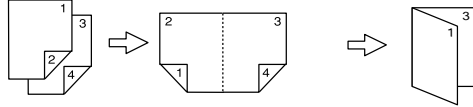

Open to Right

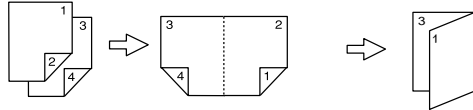

1-sided → Magazine (see p.50 "❖ 1 Sided → Magazine")

Open to Left

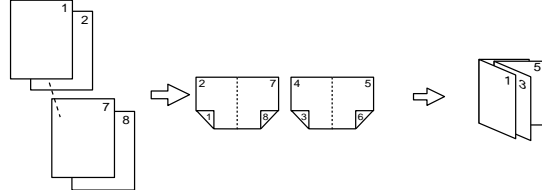

Open to Right

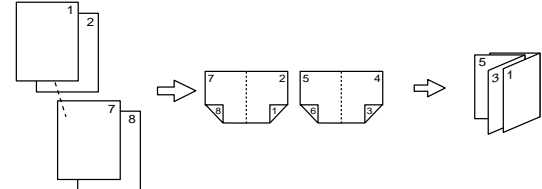

2-sided → Magazine (see p.51 "❖ 2 Sided → Magazine")

Open to Left

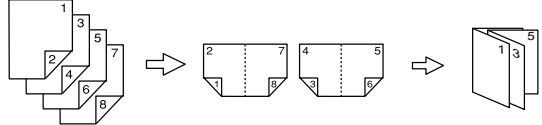

Open to Right

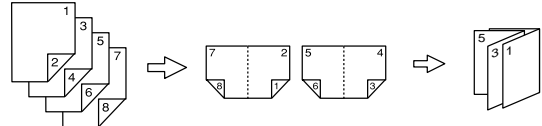

Combining Multiple Pages onto a Single Page (see p.45 " One-Sided Combine")

● 1-sided 2 Pages → 1-sided 1 Page

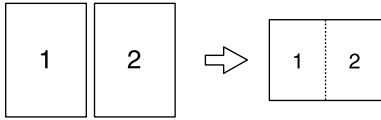

● 2-sided 1 Page → 1-sided 1 Page

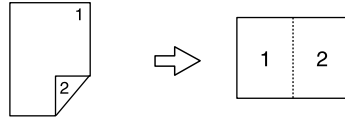

● 1-sided 4 Pages → 1-sided 1 Page

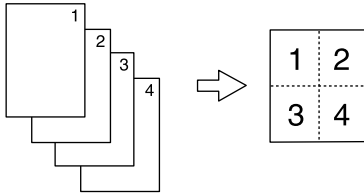

● 2-sided 2 Pages → 1-sided 1 Page

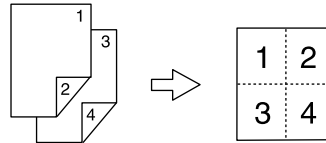

● 1-sided 8 Pages → 1-sided 1 Page

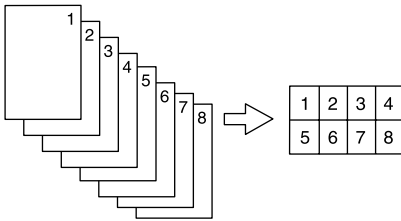

● 2-sided 4 Pages → 1-sided 1 Page

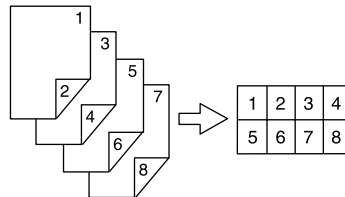

Copying Originals Such as Books (see p.48 "Series Copies")

● Bound Originals → 1-sided Pages

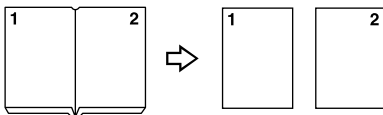

Copying 2-Sided Pages onto 1-Sided Pages (see p.43 "2 Sided → 1 Sided")

● 2-sided 1 page → 1-sided 2 pages

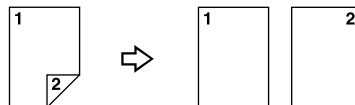

● Bound Originals → 2-sided Pages

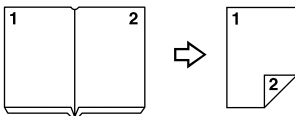

● Front/Back Bound Originals → 2-sided Pages

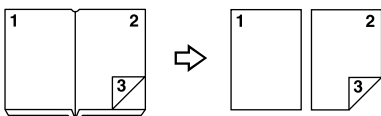

TABLE OF CONTENTS

Manuals for This Machine	i
What You Can Do with This Machine	iii
How to Read This Manual	1
Machine Types	2
Functions that Require Options	3
Control Panel	4
Display Panel	6

1. Placing Originals

Originals	7
Sizes and Weights of Recommended Originals	7
Sizes Detectable by the Auto Paper Select	8
Missing Image Area	9
Placing Originals	10
Original Orientation	10
Placing Originals on the Exposure Glass.....	11
Placing Originals in the Auto Document Feeder	12

2. Copying

Basic Procedure	15
Interrupt Copy	16
Original Beeper	16
Job Preset	17
Copying from the Bypass Tray	18
Copier Functions	21
Adjusting Image Density	21
Selecting Original Type Setting.....	22
Selecting Copy Paper	23
Preset Reduce/Enlarge	26
Zoom	27
Auto Reduce/Enlarge	28
Size Magnification	28
Directional Magnification (%)	29
Directional Size Magnification (mm).....	30
Sort.....	31
Stack	34
Staple	35
Punch	41
Duplex	43
One-Sided Combine.....	45
Two-Sided Combine.....	47
Series Copies.....	48
Booklet/Magazine.....	50
Image Repeat.....	52
Double Copies.....	53
Centring.....	54

Positive/Negative	55
Erase	55
Margin Adjustment	58
Background Numbering	59
Preset Stamp	59
User Stamp	60
Date Stamp	63
Page Numbering	65
Covers	68
Designate	69
Chapter	70
Slip Sheets	71
Storing Data in the Document Server	72
Programs	73
Storing a Program	73
Changing a Stored Program	74
Deleting a Program	74
Recalling a Program.....	74
3. Troubleshooting	
<hr/>	
If Your Machine Does Not Operate As You Want.....	75
When a Message Is Displayed.....	75
If You Cannot Make Clear Copies.....	77
If You Cannot Make Copies As You Want	78
When Memory Is Full	81
4. User Tools (Copier/Document Server Features)	
<hr/>	
User Tools Menu (Copier/Document Server Features)	83
Accessing User Tools (Copier/Document Server Features).....	89
Quitting User Tools	89
General Features ¹ / ₄	90
General Features ² / ₄	92
General Features ³ / ₄	93
General Features ⁴ / ₄	93
Reproduction Ratio ¹ / ₂	94
Reproduction Ratio ² / ₂	94
Edit ¹ / ₂	95
Edit ² / ₂	96
Stamp.....	98
Input/Output	101
5. Specifications	
<hr/>	
Combination Chart.....	103
Supplementary Information	104
INDEX.....	116

How to Read This Manual

Symbols

The following set of symbols is used in this manual.

WARNING:

This symbol indicates a potentially hazardous situation that might result in death or serious injury when you misuse the machine without following the instructions under this symbol. Be sure to read the instructions, all of which are described in the Safety Information section.

CAUTION:

This symbol indicates a potentially hazardous situation that might result in minor or moderate injury or property damage that does not involve personal injury when you misuse the machine without following the instructions under this symbol. Be sure to read the instructions, all of which are described in the Safety Information section.

* The statements above are notes for your safety.

Important

If this instruction is not followed, paper might be misfed, originals might be damaged, or data might be lost. Be sure to read this.

Preparation

This symbol indicates information or preparations required prior to operating.

Note

This symbol indicates precautions for operation, or actions to take after abnormal operation.

Limitation

This symbol indicates numerical limits, functions that cannot be used together, or conditions in which a particular function cannot be used.

Reference

This symbol indicates a reference.

[]

Keys that appear on the machine's display panel.

[]

Keys built into the machine's control panel.

Machine Types

This machine comes in two models which vary by copy speed. To make sure which model you have, see the inside front cover of this manual.

	Type 1	Type 2
Copy speed	35 copies/minute (A4 \square , 8 ¹ / ₂ " \times 11" \square)	45 copies/minute (A4 \square , 8 ¹ / ₂ " \times 11" \square)

Functions that Require Options

The available functions depend on your machine configuration and which options you have. See the table below.

mRequired options

Functions		Batch mode	SADF	Auto Document Feeder Mixed Size mode	Shift Sort	Shift Stack	Staple	Saddle Stitch	Punch
Options	Auto Document Feeder (ADF)	m	m	m					
	1000-Sheet finisher * ¹				m	m	m		
	2 Tray finisher * ¹				m	m	m		m
	Booklet finisher * ¹				m	m	m	m	

*¹ The bridge unit and paper tray unit are required when you install the finisher.

Control Panel

Note

This illustration shows the control panel of the machine with options fully installed.

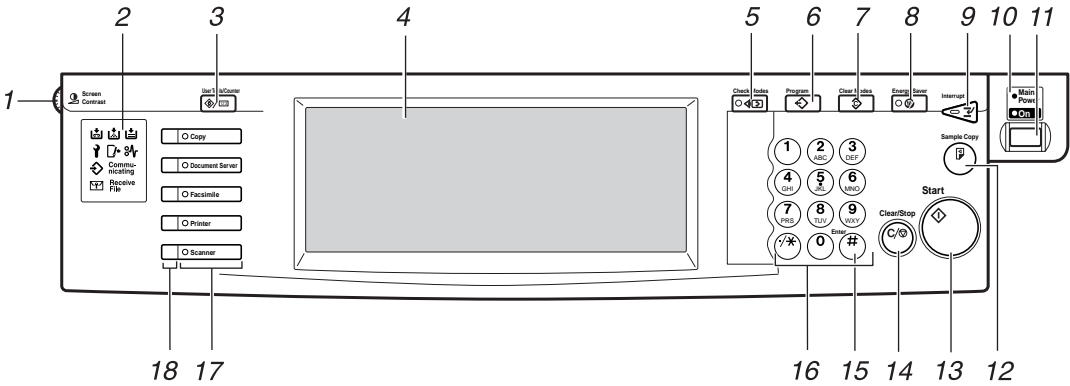

1. Screen Contrast knob

Adjusts the brightness of the display panel.

2. Indicators

Shows errors and machine status.

- : Add Staple indicator
- : Add Toner indicator
- : Load Paper indicator
- : Service Call indicator
- : Open Cover indicator
- : Misfeed indicator

See "Control Panel", *General Settings Guide*.

3. [User Tools/Counter] key

- User Tools
Press to change the default and conditions to meet your requirements.
- Counter
Press to check or print the counter value.

4. Display panel

Shows operation status, error messages, and function menus.

5. [Check Modes] key

Press to check the entered copy job settings.

6. [Program] key

Press to select the program mode. See p.73 "Programs".

7. [Clear Modes] key

Press to clear previously entered copy job settings.

8. [Energy Saver] key

Press to switch to and from the Energy Saver mode. See *General Settings Guide*.

9. [Interrupt] key

Press to interrupt a long copy job to make copies. See p.16 "Interrupt Copy".

10. Main power indicator

The main power indicator goes on when you turn on the main power. The power indicator lights when the power is on.

Important

Do not turn off the main power switch while the power indicator goes on or is flashing. The hard disk may malfunction.

11. Operation switch

Press to turn the power on (the **On** indicator goes on). To turn the power off, press again (the **On** indicator goes off).

12. [Sample Copy] key

Use this key to make a single sample copy before starting a long copy run. By checking the sample copy and making any necessary changes to the image quality settings before you make multiple copies, you can save time and paper. See p.33 "Sample copy".

13. [Start] key

Press to start copying. Press to start scanning and printing in Document Server mode.

14. [Clear/Stop] key

- Clear
Press to delete a number entered.
- Stop
Press to stop a copy job in progress.

15. [#] key

Press to enter a value.

16. Number keys

Use to enter the desired number of copies and data for selected modes.

17. Function keys

Press to select the following functions:

- Copy
- Document Server
- Facsimile
- Printer
- Scanner

18. Function status indicator

These show the status of the above functions:

- Green: the function is active.
- Red: the function has been interrupted.

Display Panel

Note

The following illustrations are examples for the machine with the optional 2 Tray finisher and Large Capacity Tray (LCT) installed.

Initial copy display

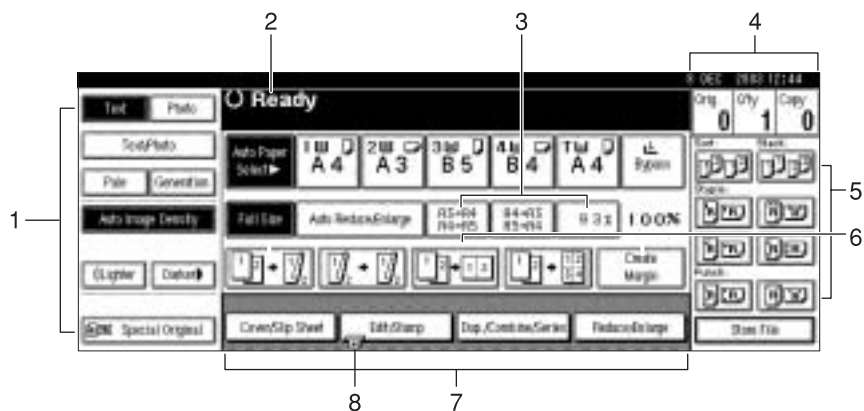

1. Original mode, Image Density and Special Original mode.

2. Operational status or messages.

3. You can register up to three frequently used reduce/enlarge ratios other than the fixed reduce/enlarge ratios. See p.94 "Shortcut R/E".

4. The number of originals scanned into memory, number of copies set, and number of copies made.

5. Sort, Stack, Staple or Punch mode.

6. Displays the contents of the Shortcut keys. You can register frequently used functions in these keys. See p.93 "Copy Function Key: F1-F5".

7. Shows the available functions. Press a function name to display its menu. For example, press the [Reduce/Enlarge] key to bring up the Reduce/Enlarge menu.







8. A clip mark appears for a currently selected function.

1. Placing Originals







Originals

Sizes and Weights of Recommended Originals

v Metric version

Where original is placed	Original size	Original weight
Exposure glass	Up to A3	--
ADF	One-sided originals: A3  - B6 JIS (Japanese Industrial Standard)  	40-128 g/m ²
	Two-sided originals: A3  - A5  	52-105 g/m ²

v Inch version

Where original is placed	Original size	Original weight
Exposure glass	Up to 11" × 17"	--
ADF	One-sided originals: 11" × 17"  - 5 ¹ / ₂ " × 8 ¹ / ₂ "  	11-34 lb.
	Two-sided originals: 11" × 17"  - 5 ¹ / ₂ " × 8 ¹ / ₂ "  	14-28 lb.

Note

- r About 80 originals can be placed in the Auto Document Feeder (ADF).
- r The weight range for originals in the Mixed Size mode is 52-81 g/m², 13.8-21.5 lb.

Non-compatible originals for the Auto Document Feeder

Placing the following types of originals in the ADF can cause paper misfeeds or result in damage to the originals. Place these originals on the exposure glass instead.

- Originals other than those specified on p.7 "Sizes and Weights of Recommended Originals".
- Stapled or clipped originals
- Perforated or torn originals

- Curled, folded, or creased originals
- Pasted originals
- Originals with any kind of coating, such as thermal fax paper, art paper, aluminum foil, carbon paper, or conductive paper
- Originals with perforated lines
- Originals with indexes, tags, or other projecting parts
- Sticky originals such as translucent paper
- Thin, highly flexible originals
- Thick originals such as postcards
- Bound originals such as books
- Transparent originals such as OHP transparencies or translucent paper

 **Note**

r The original might become dirty if it is written with a pencil or a similar tool.

Sizes Detectable by the Auto Paper Select

v Metric version

Size	A3 ☐	B4 JIS☐	A4 ☐☐	B5 JIS ☐☐	A5 ☐☐	B6 JIS☐ ☐	11" × 17" ☐	8 1/2" × 14" ☐	8 1/2" × 11" ☐☐	5 1/2" × 8 1/2" ☐☐	8 1/2" × 13" ☐ *1
Location of the original											
Exposure glass	m	m	m	m	×	×	×	×	m	×	m
ADF	m	m	m	m	m	m *2	m	×	m	×	m

*1 You can select from 8 1/2" × 13", 8 1/4" × 13", 8" × 13" with User Tools (System Settings). See "<F/F4>Size Setting" in "General Features", *General Settings Guide*.

*2 The machine cannot detect two-sided originals of B6 JIS size.

m : Detectable size × : Undetectable size

v Inch version

Size	A3 ☐	B4 JIS☐	A4 ☐☐	B5 JIS☐ ☐	A5 ☐☐	11" × 17" ☐	8 1/2" × 14" ☐	8 1/2" × 11" ☐☐	5 1/2" × 8 1/2" ☐☐	8 1/2" × 13" ☐	10" × 14" ☐
Location of the original											
Exposure glass	×	×	×	×	×	m	m	m	×	×	×
ADF	m	×	m	×	×	m	m	m	m	×	m

m : Detectable size × : Undetectable size

v Exposure glass

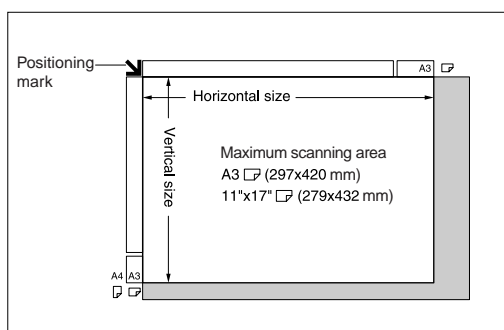

v ADF

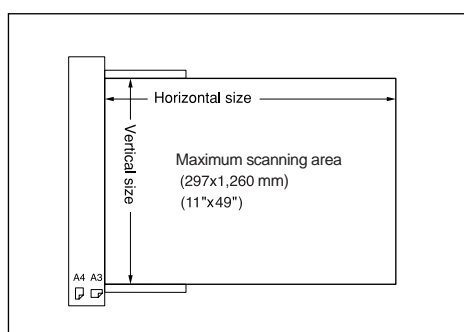

Note

- r When you copy custom size originals, make sure you specify the size of the originals. If not, the image may not be copied properly. See p.14 "Placing custom size originals".

Sizes difficult to detect

It is difficult for the machine to detect the sizes of the following originals, so select the paper size manually.

- Originals with indexes, tags, or other projecting parts
- Transparent originals such as OHP transparencies or translucent paper
- Dark originals with a lot of text and drawings
- Originals which partially contain a solid image
- Originals which have solid images at their edges

Missing Image Area

Even if you place originals in the ADF or on the exposure glass correctly, 3 mm (0.1") margins on all four sides might not be copied.

Placing Originals

1

Note

r Take care to place originals after any correction fluid and ink has completely dried. Not taking this precaution could cause marks on the exposure glass that will be copied onto paper.

Reference

For original sizes you can set, see p.7 "Originals".

Original Orientation

You can set the original orientation in the following ways.

This function is useful for copying torn originals or large originals.

v **Standard orientation** 

Select this function when the original orientation is the same as the copy paper orientation.

v **90° turn** 

Use this function when you want to copy A3, B4 JIS or 11" x 17" size originals. The machine rotates the copy image by 90° and you can make copies as you want. This is useful for copying large originals with the Staple, Duplex, Combine or Stamp functions. For example, to copy A3 or 11" x 17" originals with the Staple function selected:

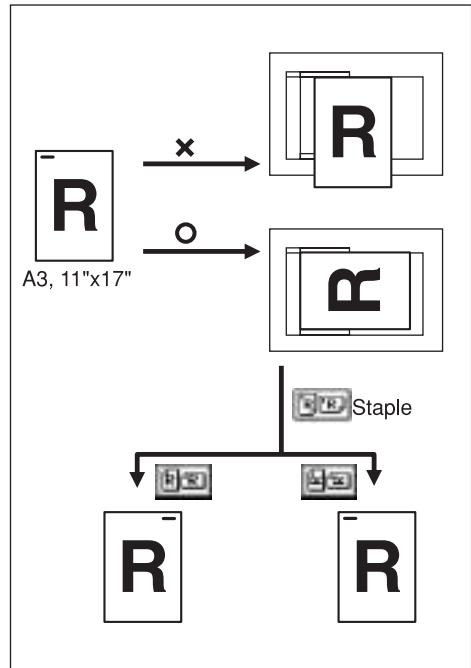

Note

r It is recommended to use this function together with the Auto Paper Select or the Preset Reduce/Enlarge function.

- 1 Press [Special Original].

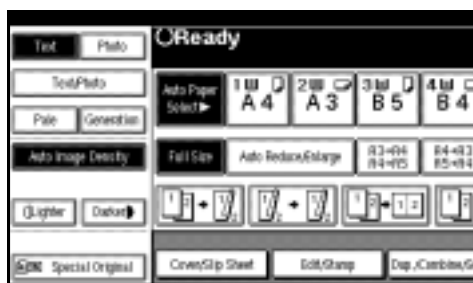

- 2 Select the original orientation.

Standard orientation

A Make sure that  is selected.



90° turn

A Place your original in the landscape orientation, and then press .



- 3 Press [OK].

Placing Originals on the Exposure Glass

- 1 Lift the exposure glass cover or ADF.

Important

- r Do not lift the exposure glass cover or ADF forcefully. Otherwise, the cover of the ADF might open or be damaged.

Note

- r Be sure to lift the exposure glass cover or ADF by more than 30°. Otherwise, the size of the original might not be detected correctly.

- 2 Place the original face down on the exposure glass. The original should be aligned to the rear left corner.

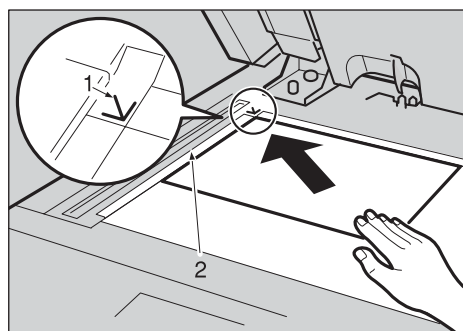

1. Positioning mark
2. Left scale

Note

- r Start with the first page to be copied.

- 3 Lower the exposure glass cover or ADF.

1

Placing Originals in the Auto Document Feeder

Settings should be made in the following situations:

- ✓ **When placing originals one by one:**
p.13 "SADF mode"
- ✓ **When placing originals consisting of more than 80 pages:**
p.12 "Batch mode"
- ✓ **When copying originals of various sizes:**
p.13 "Mixed size mode"
- ✓ **When placing custom size originals:**
p.14 "Placing custom size originals"

 **Note**

- r Do not stack originals beyond the limit mark on the side fence of the ADF.
- r The last page should be on the bottom.
- r Do not cover the sensors with your hands, or place objects on them. This could cause the size to be detected incorrectly, or the paper misfeed error message to appear. Also, do not place anything on the cover as this could cause a malfunction.

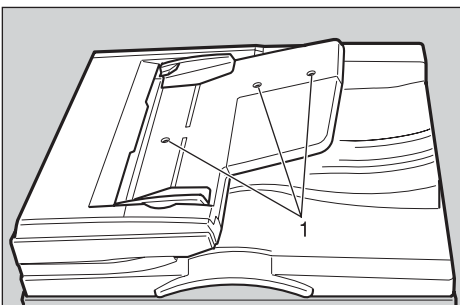

1. Sensors

- 1 Set the document guide to the original size.
- 2 Align the edges of the original and place it on the ADF with the side to be copied facing up.

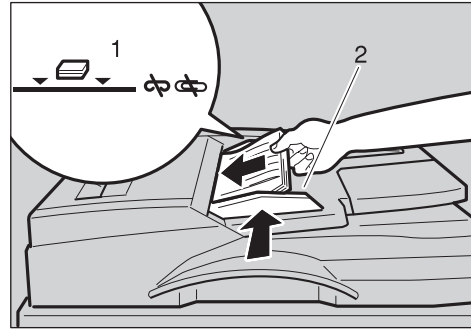

1. Limit mark
2. Document guide

 **Note**

- r Straighten curls in the originals before placing them on the ADF.
- r To prevent multiple sheets from being fed at once, fan the original before placing it on the ADF.
- r Set the original squarely.

Batch mode

In Batch mode, the machine copies an original including more than 80 pages as one document, even if it is placed on the ADF in parts.

- 1 Press [Special Original].



2 Select [Batch], and then press [OK].

 **Note**

r When [Batch] is not displayed, change the settings. See p.101 “Switch to Batch (SADF)”.

3 Place the first part of the original, and then press the [Start] key.

4 After the first part of the original has been fed, place the next part.

5 When the Sort, Combine or 1 Sided→2 Sided mode has been set, press the [#] key after all originals have been scanned.

6 Press the [Start] key.

SADF mode

In SADF mode, even when an original is placed page by page in the ADF, each page is automatically fed when placed.

 **Preparation**

To use the SADF function, you should make a setting in User Tools (Copier/Document Server Features), so that [SADF] will be displayed when you press [Special Original]. See p.101 “Switch to Batch (SADF)”.

 **Reference**

Related default settings, see p.94 “Shortcut R/E”.

1 Press [Special Original].

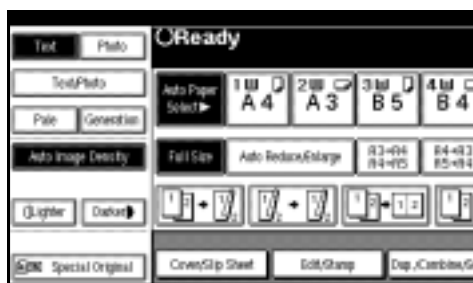

2 Press [SADF], and then press [OK].

3 Place one page of an original, and then press the [Start] key.

The Auto Feed indicator is shown on the display.

4 When the machine instructs you to place another original, place the next page.

The second and subsequent pages will be fed automatically without pressing the [Start] key.

Mixed size mode

When placing different size originals of the same width in the ADF at the same time, the machine automatically checks the size of the originals and makes copies.

 **Note**

r When placing originals of different sizes in the ADF and making copies without using the Mixed size mode, parts of the original image might not be copied or paper might become jammed.

r Copy speed and scanning speed may be reduced.

r You can place originals of two different sizes at a time.

r The sizes of the originals that can be placed together using this function are as follows:

Metric version	A3 <input type="checkbox"/> , B4 JIS <input type="checkbox"/> , A4 <input type="checkbox"/> , B5 <input type="checkbox"/> JIS <input type="checkbox"/>
Inch version	11" × 17" <input type="checkbox"/> , 8 ¹ / ₂ " × 14" <input type="checkbox"/> , 8 ¹ / ₂ " × 11" <input type="checkbox"/> , 5 ¹ / ₂ " × 8 ¹ / ₂ " <input type="checkbox"/>

1 Press [Special Original].



2 Press [Mixed Size], and then press [OK].

3 Align the rear and left edges of the originals as shown.

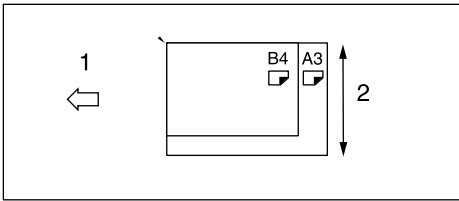

1. Place into the ADF
2. Vertical size
- 4** Adjust the guide to the widest original size.
- 5** Place the aligned originals face up into the ADF.
- 6** Press the [Start] key.

Placing custom size originals

When placing custom size originals in the ADF, specify the size of the originals.

Note

- r Paper that has a vertical length of 128–297 mm (5"–11") and a horizontal length of 128–1,260 mm (5"–49") can be placed with this function.

1 Press [Special Original].



2 Press [Custm Size Origi.].

3 Enter the horizontal size of the original with the number keys, and then press [#].

Note

- r If you make a mistake, press [Clear] or the [Clear/Stop] key, and then enter the value again.

4 Enter the vertical size of the original with the number keys, and then press [#].

5 Press [OK].

2. Copying

Basic Procedure

- 1 If the machine has user codes set, enter a user code (up to eight digits) using the number keys, and then press the [#] key.

The machine is ready to copy.

Reference

For users codes, see "Key Operator Tools", *General Settings Guide*.

- 2 Make sure "O Ready" appears on the display.

If any other function is displayed, press the [Copy] key.

v Initial copy display



- 3 Make sure no previous settings remain.

Note

r When there are previous settings remaining, press the [Reset] key and enter again.

- 4 Place your originals.

Reference

p.10 "Placing Originals"

- 5 Set your desired settings.

Reference

Please refer to each function.

- 6 Enter the required number of copies using the number keys.

Note

r The maximum copy quantity that can be set is 999.

- 7 Press the [Start] key.

Copying begins.

Note

- r When placing originals on the exposure glass, press the [#] key after all originals are scanned.
- r Copies are delivered face down.

How to operate

- v To stop the machine during a multi-copy run.
Press the [Clear/Stop] key.

- v To return the machine to the initial condition after copying.
Press the [Clear Modes] key.

- v When clearing entered values.
Press the [Clear/Stop] key or [Clear] on the display.

- v To check the settings.
Press the [Check Modes] key.

Interrupt Copy

Use this function if you want to interrupt a long copy job to make urgently needed copies.

Limitation

- r You cannot use the Interrupt Copy function when fax originals are being scanned or the scanner function is being used.

1 Press the **[Interrupt]** key.

The **Interrupt** indicator goes on.

When the originals stop scanning

A Remove the originals that were being copied and place the originals you want to copy.

B Press the **[Start] key.**

The machine starts making the copies.

C When copying is complete, remove the originals and copies.

D Press the **[Interrupt] key again.**

The **Interrupt** indicator goes off.

E When the display prompts you, place the remaining originals again before interrupting.

F Press the **[Start] key.**

Note

- r The interrupt copy job settings will be restored and the machine will continue copying from where it left off.

When the machine keeps copying

A Place the originals you want to copy.

B Press the **[Start] key.**

The machine stops the previous original job and starts copying the original.

C When copying is complete, remove originals and copies.

D Press the **[Interrupt] key again.**

The **Interrupt** indicator goes off.

The interrupt copy job settings will be restored and the machine will continue copying from where it left off.

Original Beeper

The beeper sounds and an error message is displayed when you leave your originals on the exposure glass after copying.

Note

- r See p.92 “Tone: Original remains”.

Job Preset

You can set up the next copy content during copying.

If a long copy job is in progress and you do not want to wait for it to finish, you can use this function to set up the next copy job in advance. When the current copy job is finished, the next job will start automatically.

- 1 Press **[Next Job]** when "Copying" is shown.

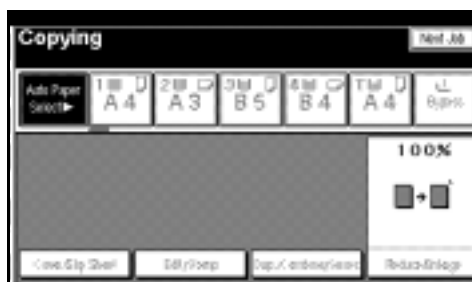

- 2 Set up the next copy job.
- 3 Place the originals in the ADF, and then press the **[Start]** key.
All originals are scanned.
- 4 Press **[To "Printing"]**.

Returns to the initial copy display.

After the current copy job, the next job starts automatically.

Note

- r You can switch the display to the current copy job by pressing **[To "Printing"]**. You can switch the display to the preset job by pressing **[To "Reserving"]**.

Copying from the Bypass Tray

Use the bypass tray to copy onto OHP transparencies, adhesive labels, translucent paper, postcards and copy paper that cannot be loaded in the paper trays.

2

Preparation

When the duplex unit is attached, the default is **[1 Sided→2 Sided]**.

When copying from the bypass tray, select **[1 Sided]** for copying in **[Dup./Combine/Series]** (for example **[1 Sided→1 Sided]** or **[2 Sided→1 Sided]**). You can change the initial settings. See p.92 "Duplex Mode Priority".

Important

When paper larger than 433 mm in size is used, the paper may become wrinkled, may not be fed into the machine, or may cause paper jams.

Note

If you do not use the standard size copy paper or if you use special paper, you should input vertical and horizontal dimensions. See p.14 "Placing custom size originals". The sizes that you can input are as follows:

Metric version	<ul style="list-style-type: none"> Vertical: 100–297 mm Horizontal: 148–600 mm *1
Inch version	<ul style="list-style-type: none"> Vertical: 3.9"–11.6" Horizontal: 5.8"–23.4" *1

*1 The range is 148–432 mm (5.8"–17") when the booklet finisher is installed.

The machine can automatically detect the following sizes as standard size copy paper:

Metric version	A3, A4, A5, 8 1/2" × 13"
Inch version	A3, 11" × 17", 8 1/2" × 11", 5 1/2" × 8 1/2"

- When copying on OHP transparencies or paper heavier than 128 g/m² (about 34 lb.), you need to specify the paper type. See p.20 "When copying onto special paper".
- The maximum number of sheets you can load at the same time depends on paper type. The maximum number of sheets should not exceed the upper limit.

1 Open the bypass tray.

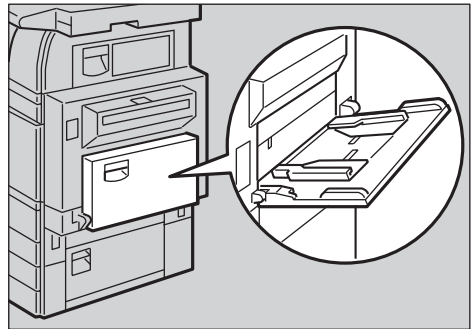

2 Insert the paper with the side you want to copy facing down until you hear the beep, and then align the paper guide to the paper size.

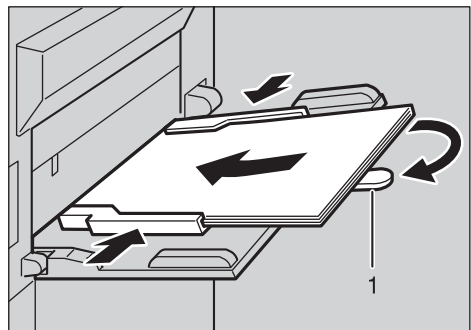

1. Extender

Note

- r If the guides are not flush against the copy paper, images might be skewed or paper mis-feeds might occur.
- r Do not stack paper over the limit mark, otherwise images might be skewed or paper mis-feeds might occur.
- r Swing out the extender to support paper sizes larger than A4, 8¹/₂" × 11".
- r Fan paper to get air between the sheets and avoid a multi-sheet feed.

3 Select the type and size of the paper.

When copying onto standard size paper

- A Press the [#] key.
- B Press [Select Size].



- C Select the paper size.
- D Press [OK].

When copying onto custom size paper

Note

- r Paper will be automatically delivered to the internal tray.
- A Press the [#] key.
 - B Press [Custom Size].



- C Press [Vertical mm], enter the vertical size with the number keys, and then press the [#] key.
- D Enter the horizontal size of the paper with the number keys, and then press the [#] key.

Note

- r If [Horiz mm] is not highlighted, press [Horiz mm].
- r To register the custom size entered, press [Program], and then press [Exit].



- E Press [OK].

When copying onto special paper

- A Press the **[#]** key.
- B Select paper type in **Special paper**.
- C Press **[OK]**.

2

4 Place your originals, and then press the **[Start]** key.

 **Note**

- r When copying onto OHP transparencies, remove copied sheets one by one.

5 When your copy job is finished, press the **[Clear Modes]** key to clear the settings.

Copier Functions

Adjusting Image Density

There are three types of adjustment available:

- v **Auto Image Density**
 The machine automatically adjusts image density.
- v **Manual image density**
 You can adjust the density of the overall original in seven increments.
- v **Combined auto and manual image density**
 Use when copying originals with a dirty background (such as newspapers). You can adjust foreground density while leaving the background unchanged.

Auto image density

- 1 Make sure that [Auto Image Density] is selected.

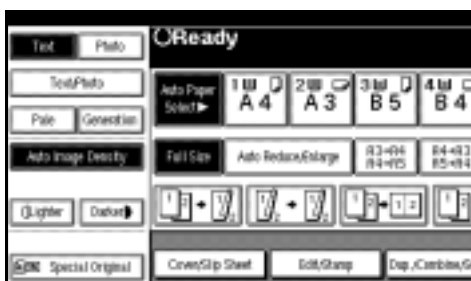

Manual image density

- 1 Press [Auto Image Density] to cancel it.
- 2 Press [Lighter] or [Darker] to adjust the image density.



Combined auto and manual image density

- 1 Make sure that [Auto Image Density] is selected.
- 2 Press [Lighter] or [Darker] to adjust the density.



Selecting Original Type Setting

Select one of the following six types to match your originals:

- ▼ **Text**
Select this mode when your originals contain only text (no pictures).
- ▼ **Text/Photo**
Select **[Text/Photo]** when your originals contain photographs or pictures with text.
- ▼ **Photo**
Delicate tones of photographs and pictures can be reproduced with this mode.
- ▼ **Pale**
Select this mode for originals that have lighter lines in pencil, or for faint copied slips. The faint lines will be clearly copied.
- ▼ **Generation Copy**
If your originals are copies (generation copies), the copy image can be reproduced sharply and clearly.

Reference

p.90 "Original Type Display"

p.91 "Copy Quality"

- 1** Press the appropriate key to select the original type.

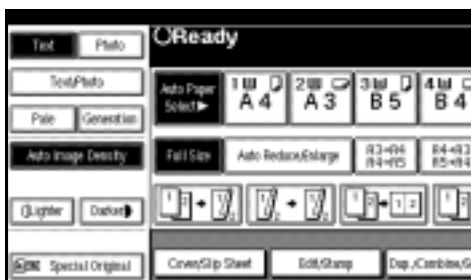

When the original type keys are not displayed

- A Press **[Original Type]**.
- B Select the original type, and then press **[OK]**.

Selecting Copy Paper

There are two ways to select copy paper:

v Auto Paper Select

The machine selects a suitable size of copy paper automatically based on original size and reproduction ratio.

v Manual Paper Select

Choose the tray containing the paper you want to copy onto: a paper tray, bypass tray or LCT.

Reference

p.9 "Sizes difficult to detect"

p.90 "Paper Display"

Note

- r See the following table for copy paper sizes and orientations that can be used with Auto Paper Select (when copying at a ratio of 100%).

v Metric version

Where original is placed	Paper size and orientation
Exposure glass	A3☐, B4 JIS☐, A4☐☐, B5 JIS☐☐
ADF	A3☐, B4 JIS☐, A4☐☐, B5 JIS☐☐, A5☐☐, B6 JIS☐☐, 11"×17"☐, 8 ¹ / ₂ "×11"☐☐

v Inch version

Where original is placed	Paper size and orientation
Exposure glass	11"×17"☐, 8 ¹ / ₂ "×14"☐, 8 ¹ / ₂ "×11"☐☐
ADF	A3☐, A4☐☐, 11"×17"☐, 8 ¹ / ₂ "×14"☐, 8 ¹ / ₂ "×11"☐☐, 5 ¹ / ₂ "×8 ¹ / ₂ "☐☐, 10"×14"☐

- r Only the paper trays set to **[No display]** or **[Recycled paper]** in Paper Type and also set to **[Yes]** in Apply Auto Paper Select can be selected in Auto Paper Select mode. See "Paper Type: Tray 1–4" in "Tray Paper Settings", *General Settings Guide*.

Auto Paper Select

- 1 Make sure that [Auto Paper Select] is selected.

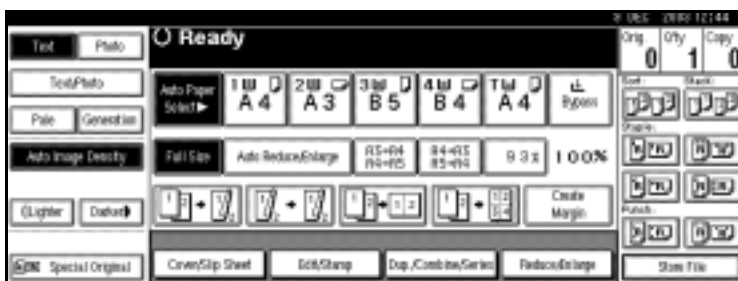

Note

- Trays with a key mark will not be automatically selected. See “Paper Type” in “Tray Paper Settings”, *General Settings Guide*.

Manual Paper Select

- 1 Select the paper tray, bypass tray or the LCT.

The indicator corresponding to the selected paper tray is highlighted.

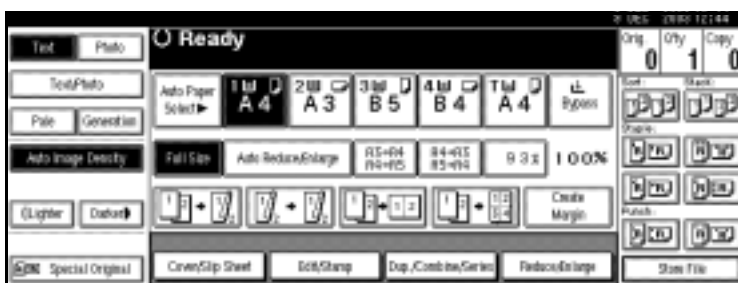



Reference

p.18 “Copying from the Bypass Tray”

When the paper type keys are not displayed

- A Press [Auto Paper Select].
- B Select the paper type.





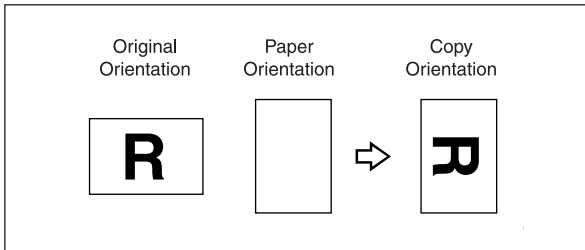

Rotated copy

If the orientation in which your original is placed ( or ) is different from that of the paper you are copying onto, this function rotates the original image by 90° to fit it on the copy paper. This function works when Auto Paper Select or Auto Reduce/Enlarge is selected. See p.23 “Auto Paper Select”.



Note

- r The default for Auto Tray Switching is With image rotation, you cannot use the Rotated Copy function if this setting is changed to Without image rotation or Off. See p.90 “Auto Tray Switching”.
- r You cannot use the Rotated Copy function when enlarging onto A3, B4 JIS or 11" × 17", 8¹/₂" × 14" size paper. In this case, place your original in the  orientation.

	Original size and orientation		Copy paper size and orientation
You cannot rotate:	A4, B5 JIS, or A5 		When enlarging to → B4 JIS, A3 
However, you can use:	A4, B5 JIS, or A5 		When enlarging to → B4 JIS, A3 

- r You cannot use the Rotated Copy function when “Left 2” or “Top 2” is selected for stapling or if the Punch function is selected when using the 2 Tray finisher. See p.35 “Staple” and p.41 “Punch”.
- r You cannot use the Rotate Copy function if “Left 2”, “Top 2” or “Saddle Stitch” is selected for the stapling when using the booklet finisher.

Preset Reduce/Enlarge

You can select a preset ratio for copying.

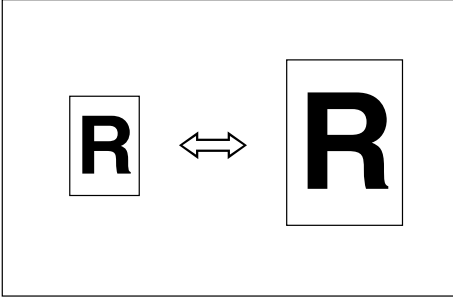

v Base Point

The base point of Reduce/Enlarge differs depending on how the original is scanned. When the original is placed on the exposure glass, the upper left corner will be the base point. When it is placed in the ADF, the bottom left corner will be the base point.

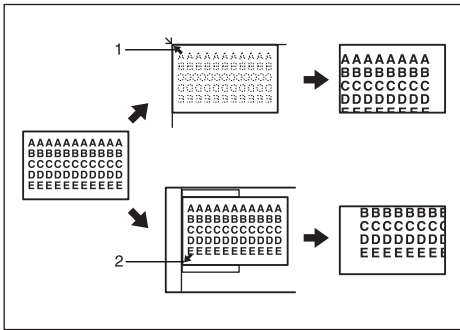

1. Base point when placing on the exposure glass.

2. Base point when placing in the ADF.

🔍 Reference

- Related initial settings
- p.94 "Shortcut R/E"
- p.95 "R/E Priority"

1 Press [Reduce/Enlarge].

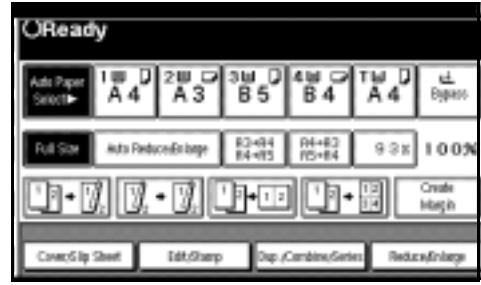

📌 Note

- r To select a preset ratio on the initial display, press the shortcut reduce/enlarge key and proceed to step 4.

2 Press [Enlarge] or [Reduce].

3 Select a ratio, and then press [OK].

4 Place your originals, and then press the [Start] key.

💡 Create margin mode

Use Create Margin to reduce the image to 93% of its original size with the centre as reference. You can assign this function to a shortcut key on the initial display. By combining it with the Reduce/Enlarge function, you can also provide the Reduce/Enlarge copy with a margin.

🔍 Reference

- Related initial settings
- p.93 "Copy Function Key: F1-F5"
- p.95 "Ratio for Create Margin"

- 1 Press **[Create Margin]** displayed on the initial display.

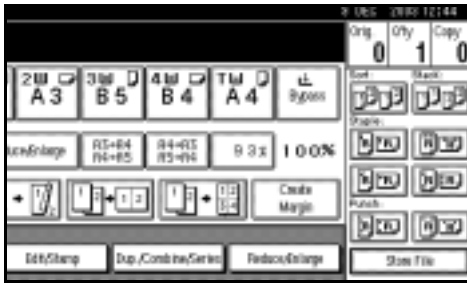

- 2 If you do not want to combine it with the Reduce/Enlarge function, place your originals, and then press the **[Start]** key.

Zoom

You can change the reproduction ratio in increments of 1%.

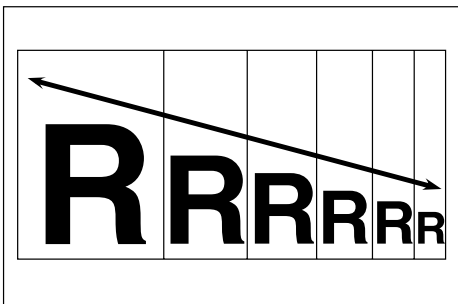

Note

- r You can also select a preset ratio near the desired ratio using **[Reduce]** or **[Enlarge]**, and then adjust the ratio with **[+]** or **[-]**.

- 1 Press **[Reduce/Enlarge]**.

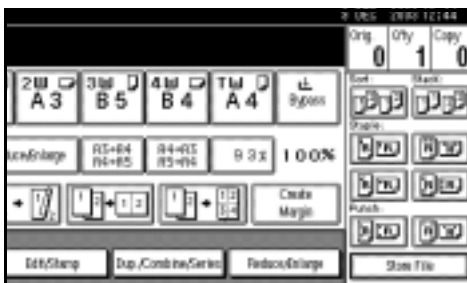

- 2 Enter the ratio.

To select the ratio with **[+]** and **[-]**

- A Select a preset ratio close to the desired ratio by using **[Reduce]** or **[Enlarge]**.
- B Adjust the ratio with **[+]** or **[-]**.

Note

- r To change the ratio in increments of 1%, press **[+]** or **[-]**. To change the ratio in increments of 10%, press and hold down **[+]** or **[-]**.
- r If you have incorrectly entered the ratio, readjust with **[+]** or **[-]**.

To enter the ratio with the number keys

- A Press **[Mag. Ratio]**.
- B Enter the desired ratio with the number keys.
- C Press **[#]**.
- D Press **[OK]**.

- 3 Place your originals, and then press the **[Start]** key.

Auto Reduce/Enlarge

The machine can choose an appropriate reproduction ratio based on the paper and original sizes you select.

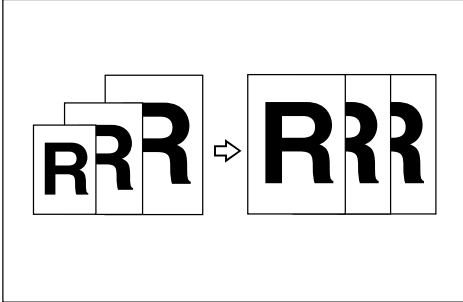

Note

- r You cannot use the bypass tray with this function.
- r When using Auto Reduce/Enlarge, see the following table for original sizes and orientations you can use:

v Metric version

Where original is placed	Original size and orientation
Exposure glass	A3☐, B4 JIS☐, A4☐☐, B5 JIS☐☐
ADF	A3☐, B4 JIS☐, A4☐☐, B5 JIS☐☐, A5☐☐, B6 JIS☐☐, 11"×17"☐☐, 8 ¹ / ₂ "×11"☐☐

v Inch version

Where original is placed	Original size and orientation
Exposure glass	11"×17"☐, 8 ¹ / ₂ "×14"☐, 14"☐, 8 ¹ / ₂ "×11"☐☐
ADF	A4☐☐, 11"×17"☐, 8 ¹ / ₂ "×14"☐, 8 ¹ / ₂ "×11"☐☐, 5 ¹ / ₂ "×8 ¹ / ₂ "☐☐

Reference

p.9 "Sizes difficult to detect"

1 Press [Auto Reduce/Enlarge].

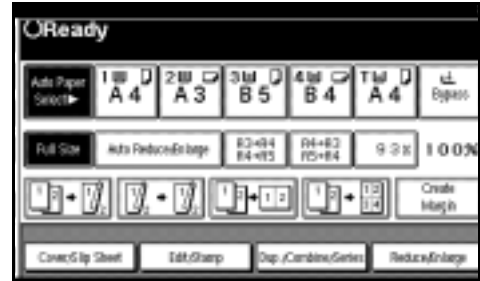

2 Select the paper tray.

3 Place your originals, and then press the [Start] key.

Size Magnification

This function calculates an enlargement or reduction ratio based on the lengths of the original and copy.

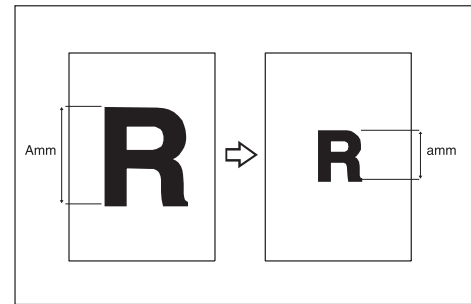

Note

- r Measure and specify the lengths of the original and copy by comparing "A" with "a".

1 Press [Reduce/Enlarge].

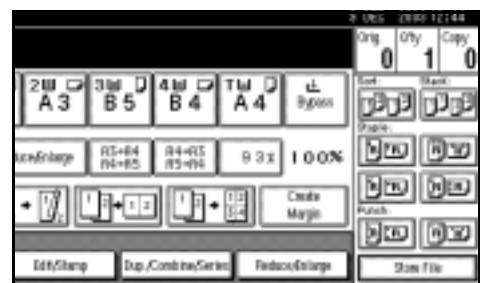

- 2** Press [**Specifd. Ratio**].
- 3** Make sure that [**Specifd. Ratio**] is highlighted.
- 4** Enter the length of the original with the number keys, and then press the [**#**] key.

Note

r You can enter sizes within the following ranges:

Metric version	1–999 mm (in increments of 1 mm)
Inch version	0.1"–99.9" (in increments of 0.1")

- 5** Enter the length of the copy with the number keys, and then press [**#**].

Note

r To change the length after pressing [**#**], select [**Original**] or [**Copy**] and enter the desired length.

- 6** Press [**OK**].
- 7** Press [**OK**].
- 8** Place your originals, and then press the [**Start**] key.

Directional Magnification (%)

Copies can be reduced or enlarged at different reproduction ratios, horizontally and vertically.

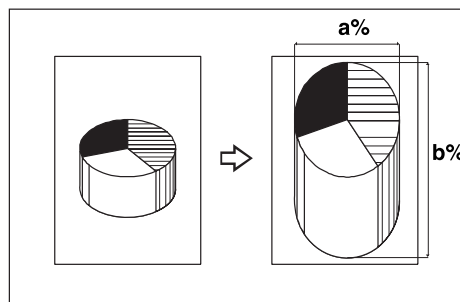

1. Horizontal ratio
2. Vertical ratio

Note

r You can also select a preset ratio close to the desired ratio using [**Reduce**] or [**Enlarge**], then adjust with [**+**] or [**-**].

- 1** Press [**Reduce/Enlarge**].

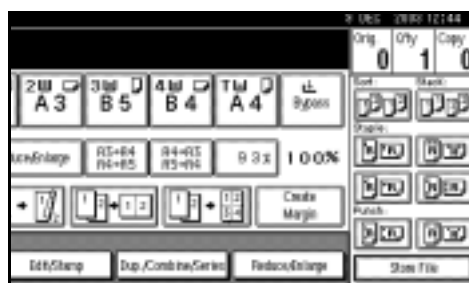

- 2** Press [**Specifd. Ratio**].
- 3** Press [**Direct. Mag.%**].

To enter the ratio with the number keys

- A Press [**Horizontal**].
- B Enter the desired ratio with the number keys, followed by [**#**].

- C Press [Vertical].
- D Enter the desired ratio with the number keys, followed by [#].
- E Press [OK].

To specify a ratio with [+] and [-]

- A Press [With +-].
- B Press [Horizontal].
- C Adjust the ratio using [+] or [-].

 **Note**

- r Pressing [+] or [-] changes the ratio in increments of 1%. Pressing and holding down [+] or [-] changes it in increments of 10%.
- r If you have incorrectly entered the ratio, readjust the ratio with [+] or [-].

- D Press [Vertical].
- E Adjust the ratio with [+] or [-].
- F Press [OK].

- 4** Press [OK].
- 5** Place your originals, and then press the [Start] key.

Directional Size Magnification (mm)

The suitable reproduction ratios will be automatically selected when you enter the horizontal and vertical lengths of the original and copy image you require.

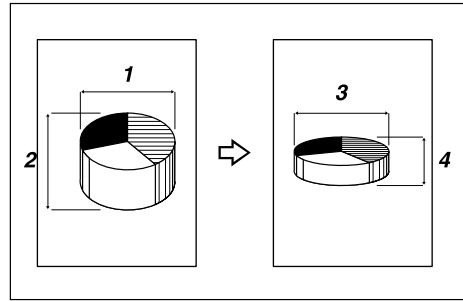

1. Horizontal original size
2. Vertical original size
3. Horizontal copy size
4. Vertical copy size

 **Note**

- r Specify the vertical and horizontal sizes of the original and those of the copy, as shown.
- r You can enter sizes within the following ranges:

Metric version	Vertical: 1-999 mm (in increments of 1 mm) Horizontal: 1-999 mm (in increments of 1 mm)
Inch version	0.1"-99.9" (in increments of 0.1")

1 Press [Reduce/Enlarge].

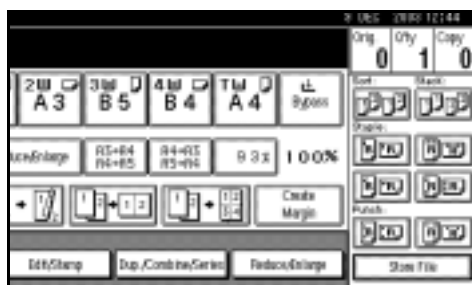

2 Press [Specifd. Ratio].

3 Press [Dir. Size Mag mm].

4 Enter the horizontal size of the original with the number keys, and then press [#].

5 Enter the horizontal size of the copy with the number keys, and then press [#].

6 Enter the vertical size of the original with the number keys, and then press [#].

7 Enter the vertical size of the copy with the number keys, and then press [#].

Note

r To change a length, press the key you want to change and enter the new value.

8 Press [OK].

9 Press [OK].

10 Place the originals, and then press the [Start] key.

Sort

The machine can scan originals into memory and automatically sort copies.

Reference

Related initial settings

p.102 "Select Stack Function"

p.101 "Memory Full Auto Scan Re-start"

p.101 "Rotate Sort: Auto Paper Continue"

p.90 "Auto Tray Switching"

v Sort

Copies are assembled as sets in sequential order.

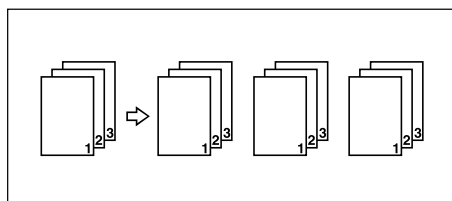

v Rotate Sort

Every other copy set is rotated by 90° and delivered to the copy tray.

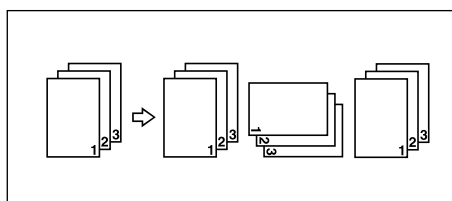

Note

r To use the Rotate Sort function, two paper trays loaded with same size and type paper, but in different orientation (90°), are required. See "Paper Type: Tray 1-4" in "Tray Paper Settings", *General Settings Guide*.

▼ **Shift Sort**

- 1000-Sheet finisher (optional)
Each time the copies of one set or those of each job are delivered, the next copy is shifted when delivered so you can separate each set or job.
- 2 Tray finisher (optional)
The shift tray moves backward or forward each time the copies of one set or those of each job are delivered, causing the next copy to shift when delivered so that you can differentiate each set or job.

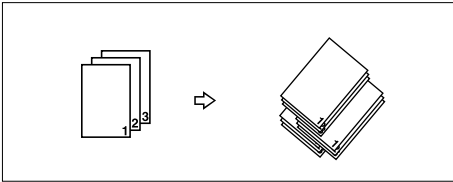

- Booklet finisher (optional)
Each time a set of copies or a job is delivered, the finisher shift tray moves backward or forward, causing the top sheet of each set to shift when delivered, separating each set or job.

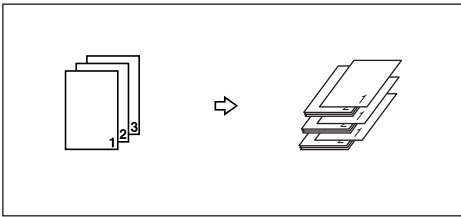

1 Press [Sort] or [Rotate Sort].

▼ **When a finisher is not installed**

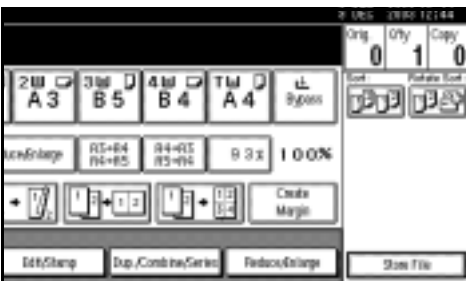

▼ **When the 1000-Sheet finisher is installed**

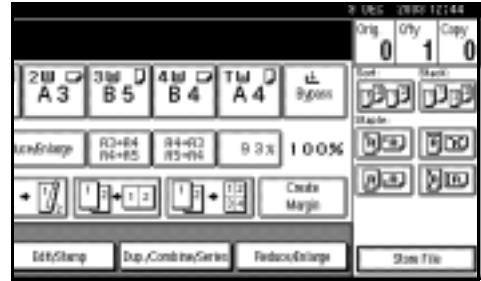

▼ **When the 2 Tray finisher is installed**

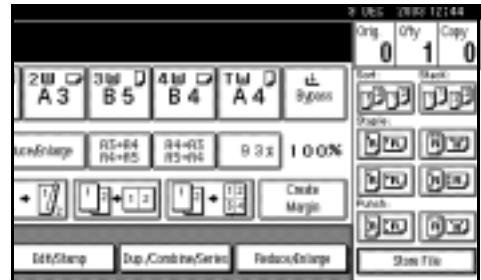

▼ **When the booklet finisher is installed**

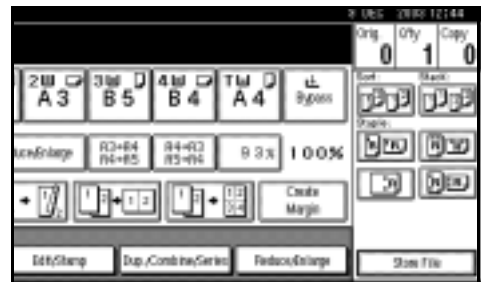

2 Enter the number of copy sets with the number keys.

Note

- r To confirm the type of finishing, press the [**Sample Copy**] key. See p.33 "Sample copy".

3 Place your originals.

Note

- r When placing an original on the exposure glass, start with the first page to be copied. When placing an original in the ADF, set so the first page is on the top.
- r When placing an original on the exposure glass or in the ADF using Batch mode, press the **[#]** key after all the originals have been scanned.

4 Press the **[Start]** key.

Sample copy

Use this function to check the copy settings before making a long copy run.

Note

- r This function can be used only when the Sort function is turned on.

1 Select Sort and any other necessary functions, and then place the originals.

2 Press the **[Sample Copy]** key.

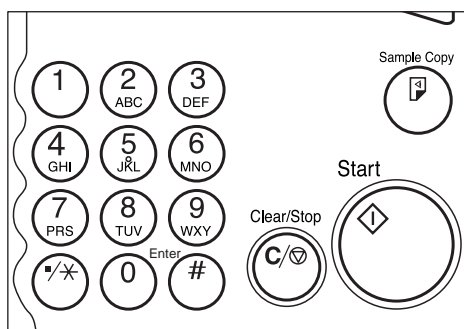

One copy set is delivered as a sample.

3 If the sample is acceptable, press **[Print]**.

The number of copies made is the number specified, minus one for the proof copy.

Note

- r If you press **[Suspend]** after checking the results, return to step 1 to adjust the copy settings as necessary. You can change the settings for Staple, Duplex (one-sided → one-sided, one-sided → two-sided), Copy Orientation, Margin Adjust., and Cover/Slip Sheet. However, depending on the combination of functions, you may not be able to change some settings.

Changing the number of sets

You can change the number of copy sets during copying.

Note

- r This function can only be used when the Sort function is turned on.

1 While "Copying" is displayed, press the **[Clear/Stop]** key.

2 Press **[Change Quantity]**.

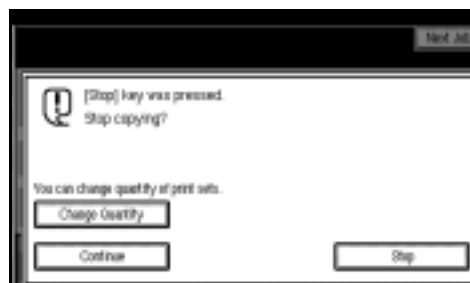

3 Enter the number of copy sets with the number keys, and then press the **[#]** key.

Note

r The number of sets you can enter differs depending on when the **[Clear/Stop]** key is pressed.

4 Press **[Continue]**.

Copying starts again.

Stack

Copies can be assembled with each page placed.

- 1000-Sheet finisher (optional)
Each time the copies of one page are delivered, the next copy is shifted when delivered so you can separate each job by page.
- 2 Tray finisher (optional)
The shift tray moves backward or forward each time the copies of one page are delivered, causing the next copy to shift when delivered so that you can separate each job by page.

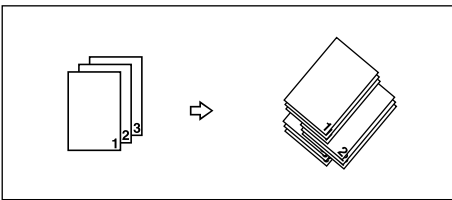

- Booklet finisher (optional)
Each time the copies of one page are delivered, the finisher shift tray moves backward or forward, causing the top sheet of each page stack to shift when delivered, separating each job by page.

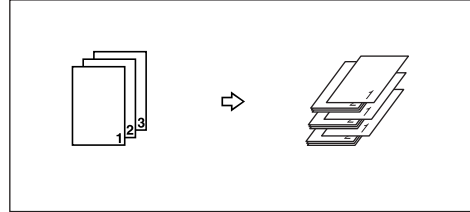

1 Press **[Stack]**.

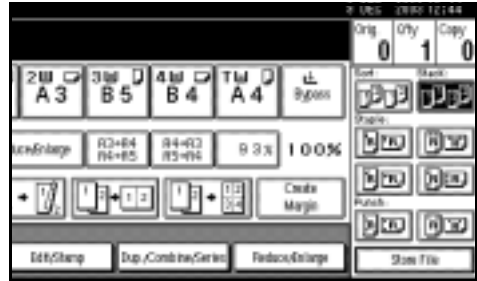

- 2** Enter the number of copies with the number keys.
- 3** Place your originals, and then press the **[Start]** key.

Note

- r When placing an original on the exposure glass, start with the first page to be copied. When placing an original in the ADF, set so the last page is on the bottom.
- r When placing an original on the exposure glass or in the ADF using Batch mode, press the **[#]** key after all the originals have been scanned.

Staple

An optional finisher and the bridge unit are required for this function.

Each copy set can be stapled together.

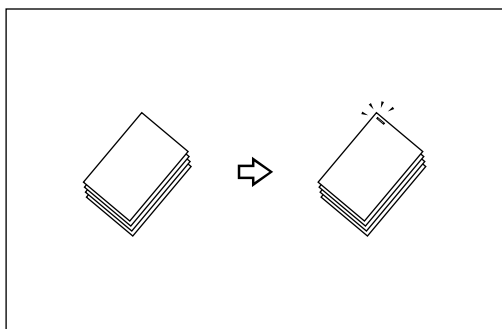

 **Note**

r You cannot use the bypass tray with this function.

 **Reference**









Related initial settings



























p.102 "Select Stapling Position"

Stapling position and original setting





































Place all the originals in the ADF in the orientation in which they can be read normally. When placing the original on the exposure glass, keep the same orientation, but set the original facing downwards. When there is copy paper that is identical in size and orientation to your original, the staple positions are as follows:









v **1000-Sheet finisher**

		Original location		Stapling position *1	
			Exposure glass		ADF
	Top				
					



















		Original location			Stapling position ^{*1}
			Exposure glass	ADF	
	Bottom				
					
	Left 2				
					
	Top 2				
					



























√ 2 Tray finisher

		Original location		Stapling position *1	
			Exposure glass		ADF
	Top				
					
	Top Slant				
					
	Bottom				
					
	Left 2				
					

		Original location		Stapling position *1	
			Exposure glass		ADF
	Top 2				
					*2 

v Booklet finisher

		Original location		Stapling position *1	
			Exposure glass		ADF
	Top				
					
	Bottom				
					

		Original location		Stapling position ^{*1}	
			Exposure glass		ADF
	Left 2				^{*2} 
					
	Top 2				
					^{*2} 
	Saddle Stitch				
					

^{*1} This table shows the stapling positions, not the orientation of delivery.

^{*2} Not available for A3 and B4 JIS size paper.

1 Select one of the stapling positions.

v 1000-Sheet finisher

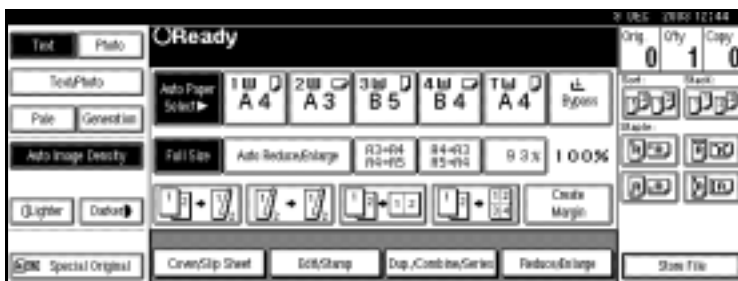

v 2 Tray finisher

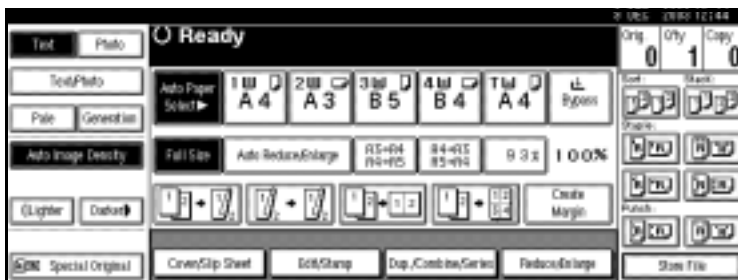

v Booklet finisher

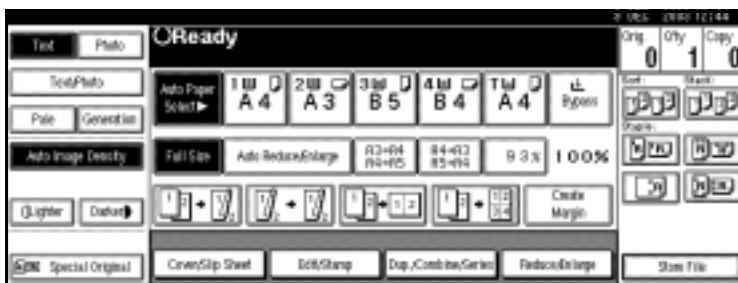

Note

r When you select the stapling position, Sort mode is automatically selected.

Reference

p.35 "Stapling position and original setting"

2 Enter the number of copy sets with the number keys.

3 Place your originals, and then press the **[Start]** key.

Note

r When placing an original on the exposure glass, start with the first page to be copied. When placing an original in the ADF, set so the last page is on the bottom.

r When placing an original on the exposure glass or in the ADF using Batch mode, press the **[#]** key after all the originals have been scanned.

Punch

The optional 2 Tray finisher and the bridge unit are required for this function.

You can make punch holes in copies.

v 2 holes

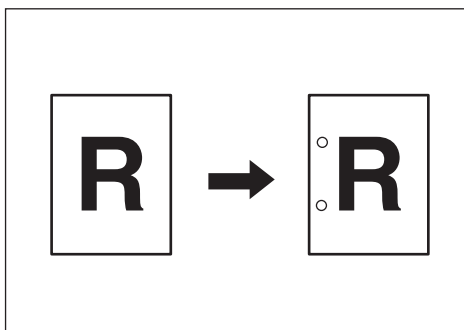

v 3 holes

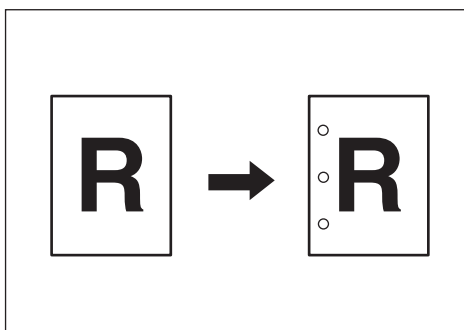



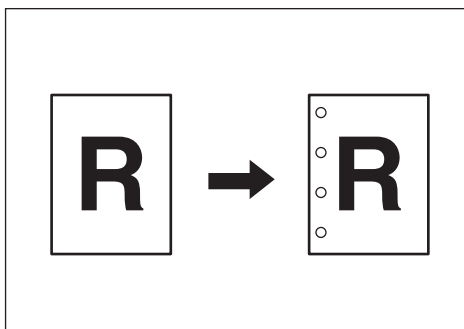













































v 4 holes



Note

- r You cannot use the bypass tray with this function.
- r The relationship between the orientation in which you place the original and the punch hole positions is as follows:

v Punch hole positions

		Original location		Punch hole positions *1	
		Exposure glass	ADF		
Standard	2 holes				
					
	3 holes				
					
	4 holes				
					
90° Turn	2 holes				
					
	3 holes				
					
	4 holes				
					

*1 This table shows the punch hole positions, not the orientation of delivery.

1 Select one of the punch hole positions.

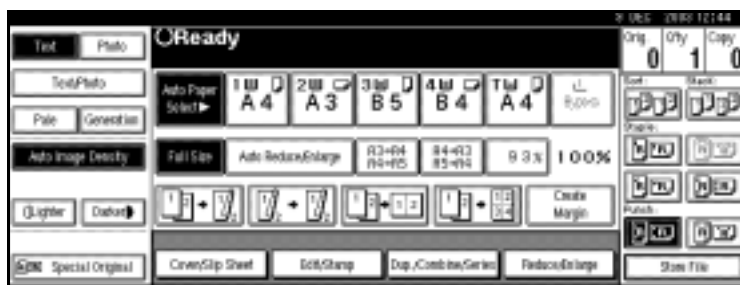

2 Enter the number of copy sets with the number keys.

3 Place your originals, and then press the **[Start]** key.

Duplex

There are three types of duplex.

v **1 Sided**→**2 Sided**

Copies 2 one-sided pages on 1 two-sided page.

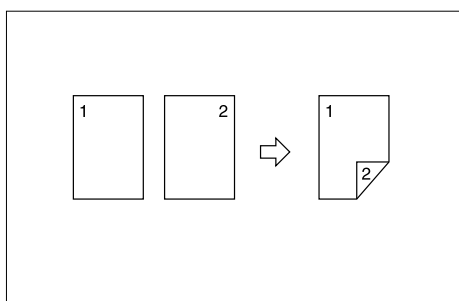

v **2 Sided**→**1 Sided**

Copies each side of a two-sided original onto two separate pages.

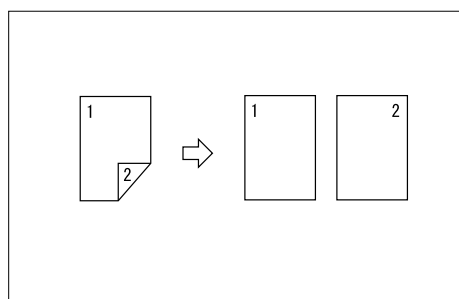



v **2 Sided**→**2 Sided**

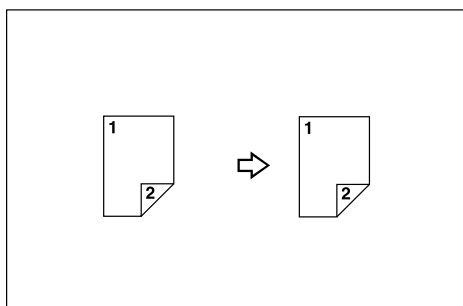







Copies 1 two-sided page on 1 two-sided page.

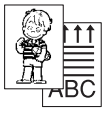

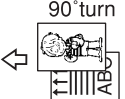
Original orientation and completed copies

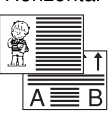
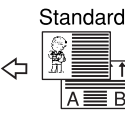
The resulting copy image will differ according to the orientation in which you place your originals (vertical  or horizontal ).

2

Original	How to Set Your Original	Copy
Vertical 	Standard 	Top to Top 
	90° turn 	Top to Bottom 
Horizontal 	Standard 	Top to Top 
	90° turn 	Top to Bottom 

*1 The table shows the orientation of images on the front and back of copies, not the orientation of delivery.

Note

- r You cannot use the bypass tray with this function.
- r The maximum paper weight that can be used with duplex copying is 64–105 g/m², 17–28 lb. (55–90 kg, 121.3–198.4 lb.).

Reference

- p.58 “Margin Adjustment”
- Related initial settings
- p.95 “Front Margin: Left/Right”
- p.95 “Back Margin: Left/Right”
- p.95 “Front Margin: Top/Bottom”
- p.95 “Back Margin: Top/Bottom”

1 Press [Dup./Combine/Series].

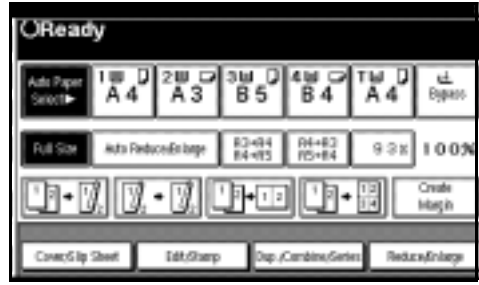

Note

- r You can also select “1 Sided to 2 Sided” or “2 Sided to 2 Sided” directly by pressing the Copy Function Key. In that case, proceed to **4**.

2 Select [1 Sided] or [2 Sided] for Original, and then select [1 Sided] or [2 Sided] for Copy.

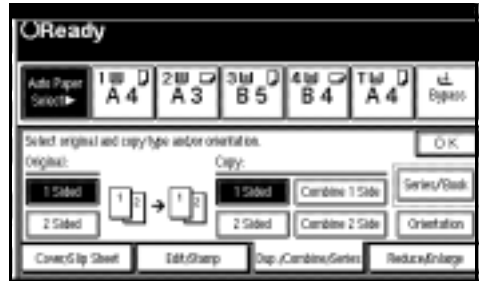

Note

- r To change the copy orientation, press [Orientation]. See p.45 “Originals and copy orientation”.

3 Press [OK].

4 Place your originals, and then press the [Start] key.

Note

- r When placing an original on the exposure glass, start with the first page to be copied. When placing an original in the ADF, set so the last page is on the bottom.

- r When placing an original on the exposure glass or in the ADF using Batch mode, press the [#] key after all the originals have been scanned.

Originals and copy orientation

You can select the orientation.

- Top to Top

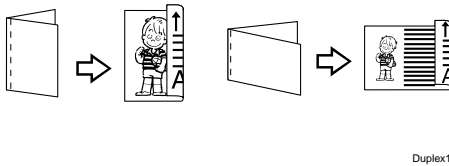

- Top to Bottom

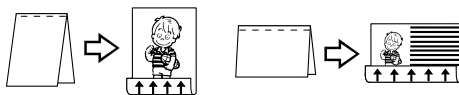

Note

- r You can change the default orientation with User Tools. See p.92 “Copy Orientation in Duplex Mode” and p.92 “Original Orientation in Duplex Mode” .

1 Press [Dup./Combine/Series].

2 Press [Orientation], select the orientation (Original/Copy), and then press [OK].

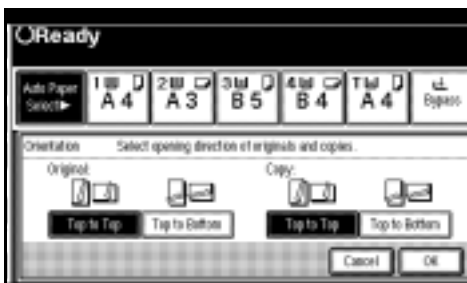

One-Sided Combine

Combine several pages onto one side of a sheet.

- v **1 Sided 2 Pages** → **Combine 1 Side**

Copies 2 one-sided originals to one side of a sheet.

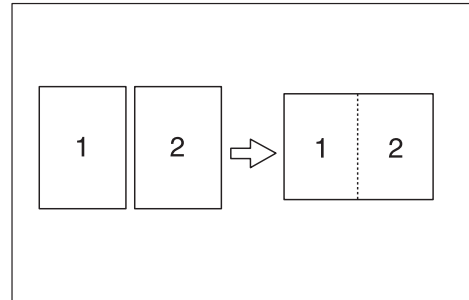

- v **1 Sided 4 Pages** → **Combine 1 Side**

Copies 4 one-sided originals to one side of a sheet.

- v **1 Sided 8 Pages** → **Combine 1 Side**

Copies 8 one-sided originals to one side of a sheet.

- v **2 Sided 1 Page** → **Combine 1 Side**

Copies 1 two-sided original to one side of a sheet.

- v **2 Sided 2 Pages** → **Combine 1 Side**

Copies 2 two-sided originals to one side of a sheet.

- v **2 Sided 4 Pages** → **Combine 1 Side**

Copies 4 two-sided originals to one side of a sheet.

- v **Orientation of the original and image position of combine**

Open to left  originals

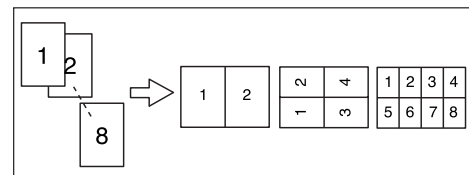

Open to top  originals

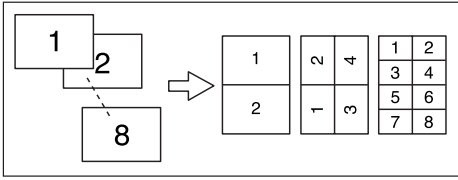

2

v **Placing originals (originals placed in the ADF)**

- Originals read from left to right

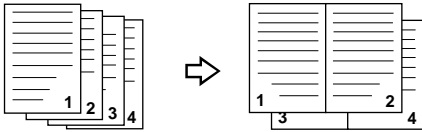

- Originals read from top to bottom

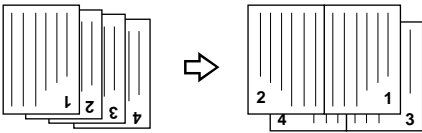

 **Note**

r You cannot use the bypass tray with this function.

 **Reference**

Related initial settings

p.96 "Erase Original Shadow in Combine"

p.98 "Copy Order in Combine"

p.97 "Separation Line in Combine"

1 Press [Dup./Combine/Series].

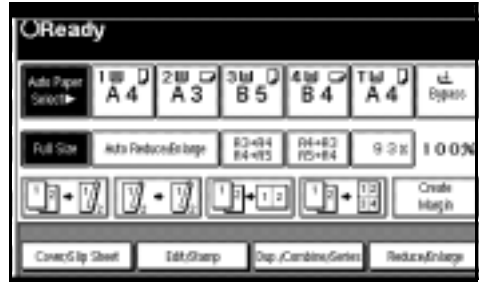

2 Press [1 Sided] or [2 Sided] for Original, and then press [Combine 1 Side] for Copy.

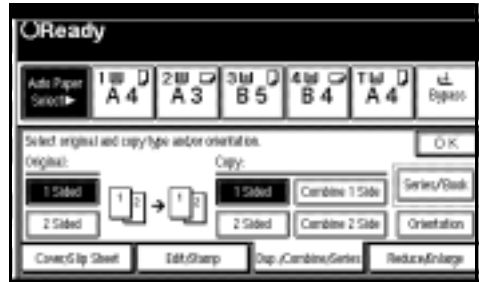

 **Reference**

p.45 "Originals and copy orientation"

3 Select the number of originals to combine, and then press [OK].

4 Select the paper size.

5 Press [OK].

6 Place your originals, and then press the [Start] key.

Two-Sided Combine

Combines various pages of originals into one sheet with two sides.

✓ **1 Sided 4 Pages → Combine 2 Side**

Copies 4 one-sided originals to one sheet with two pages per side.

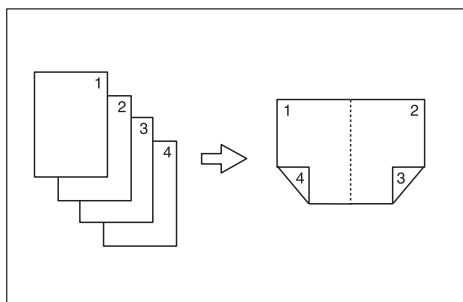

✓ **1 Sided 8 Pages → Combine 2 Side**

Copies 8 one-sided originals to one sheet with four pages per side.

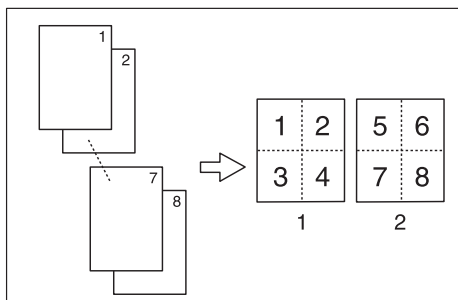

1. Front

2. Back

✓ **1 Sided 16 Pages → Combine 2 Side**

Copies 16 one-sided originals to one sheet with eight pages per side.

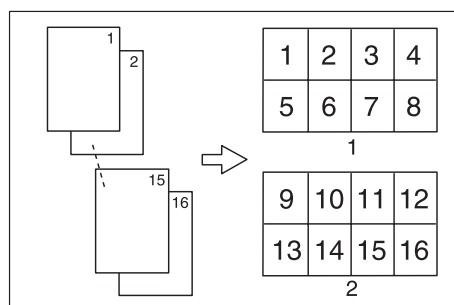

1. Front

2. Back

✓ **2 Sided 4 Pages → Combine 2 Side**

Copies 2 two-sided originals to one sheet with two pages per side.

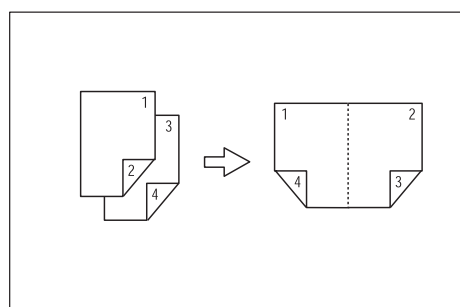

✓ **2 Sided 8 Pages → Combine 2 Side**

Copies 4 two-sided originals to one sheet with four pages per side.

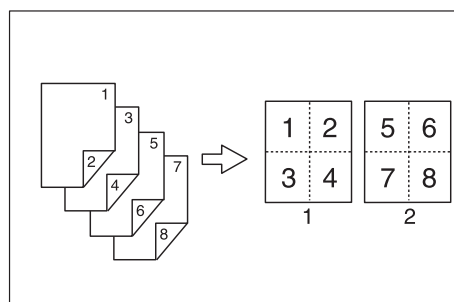

- v **2 Sided 16 Pages** → **Combine 2 Side**
Copies 8 two-sided originals to one sheet with eight pages per side.

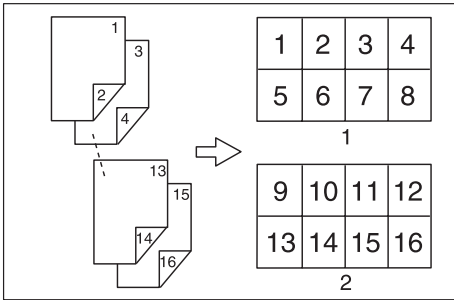

Reference

Related initial settings
 p.45 “Orientation of the original and image position of combine”
 p.96 “Erase Original Shadow in Combine”
 p.98 “Copy Order in Combine”
 p.97 “Separation Line in Combine”

- 1** Press [Dup./Combine/Series].

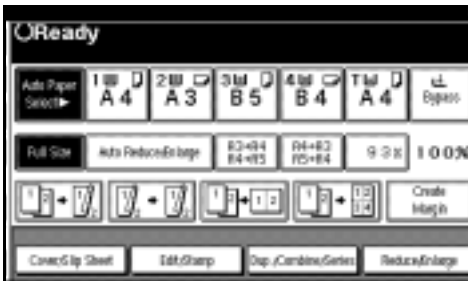

- 2** Press [1 Sided] or [2 Sided] for Original, and then press [Combine 2 Side] for Copy.

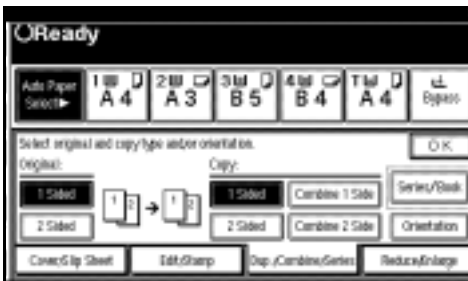

Reference

p.45 “Originals and copy orientation”

- 3** Select the number of originals to combine, and then press [OK].
- 4** Select the paper size.
- 5** Press [OK].
- 6** Place your originals, and then press the [Start] key.

Series Copies

Separately copies the front and back of a two-sided original or the two facing pages of a bound original onto two sheets.

Limitation

- r You cannot use the Series Copies function from the ADF.

- v **Book**→**1 Sided**

You can make one-sided copies from two facing pages of a bound original (book).

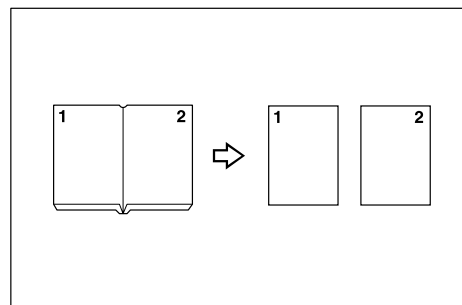

▼ **Book→2 Sided**

Copies a two-page spread original onto one sheet with one page per side.

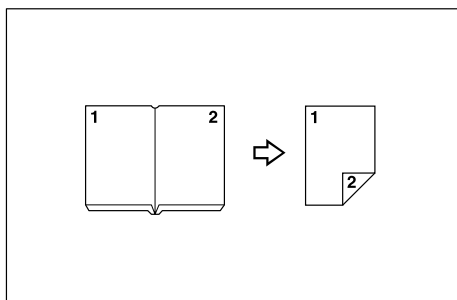

▼ **Front&Back→2 Sided**

Copies each two-page spread original as it is onto both sides of a sheet.

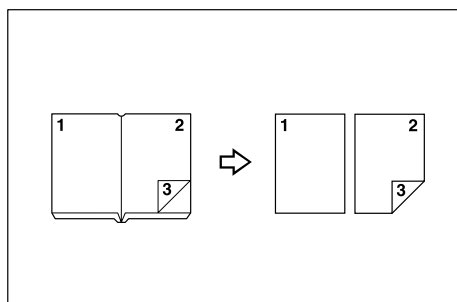

Note

r See the following table for original and copy paper sizes when using a 100% ratio.

▼ **Metric version**

Original	Paper for one-sided copy	Paper for two-sided copy
A3	A4 × 2 sheets	A4 × 1 sheet (two-sided)
B4 JIS	B5 JIS × 2 sheets	B5 JIS × 1 sheet (two-sided)
A4	A5 × 2 sheets	A5 × 1 sheet (two-sided)

▼ **Inch version**

Original	Paper for one-sided copy	Paper for two-sided copy
11" × 17"	8 1/2" × 11" × 2 sheets	8 1/2" × 11" × 1 sheet (two-sided)
8 1/2" × 11"	5 1/2" × 8 1/2" × 2 sheets	5 1/2" × 11" × 1 sheet (two-sided)

1 Press [Dup./Combine/Series].

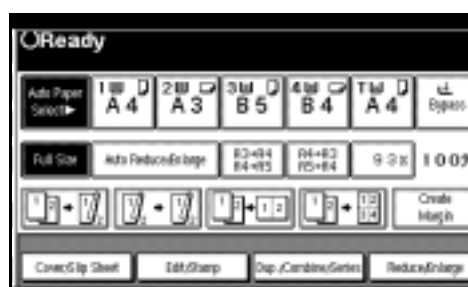

2 Press [Series/Book].

3 Press [Series].

4 Select [Book→1 Sided], [Book→2 Sided], or [Front&Back→2 Sided], and then press [OK].

5 Press [OK].

6 Make sure that [Auto Paper Select] is selected.

7 Place your original on the exposure glass, and then press the [Start] key.

Note

r Press the [#] key after all originals have been scanned.

Booklet/Magazine

Copies two or more originals in page order.

✓ **1 Sided** → **Booklet**

Make copies in page order for a folded booklet as shown.

✓ **Open to left**

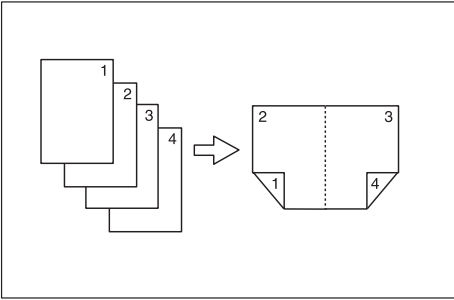

✓ **Open to right**

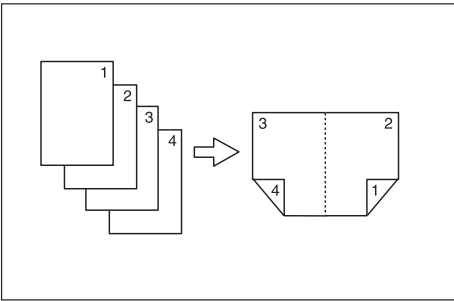

✓ **2 Sided** → **Booklet**

Make two-sided originals to copies in page order for a folded booklet as shown.

✓ **Open to left**

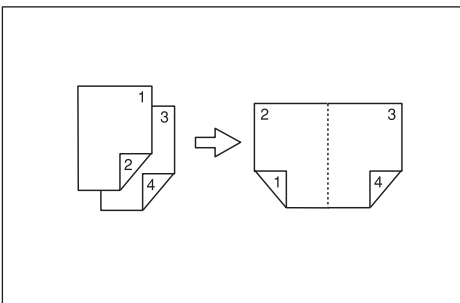

✓ **Open to right**

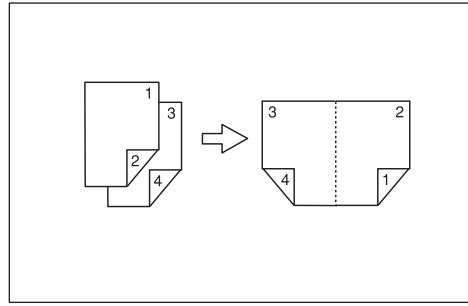

✓ **1 Sided** → **Magazine**

Copies two or more originals to make copies in page order when they are folded and stacked.

✓ **Open to left**

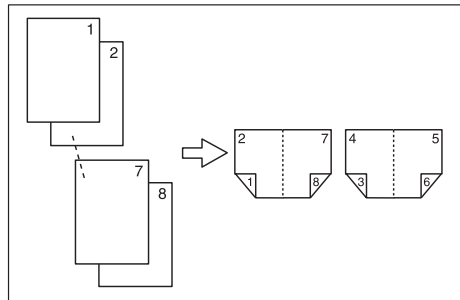

✓ **Open to right**

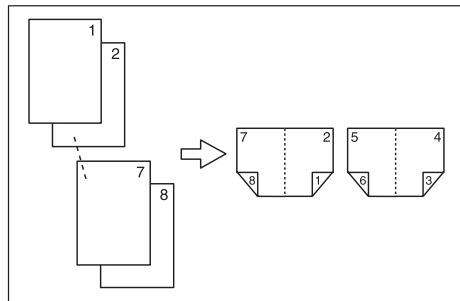

v **2 Sided**→**Magazine**

Copies two or more originals of two-sided to make copies in page order when they are folded and stacked.

v **Open to left**

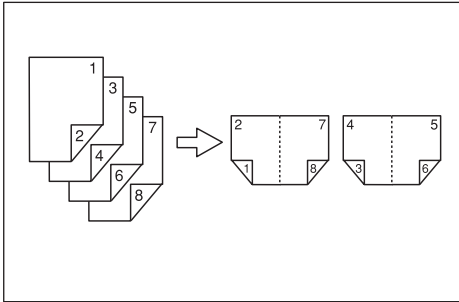

v **Open to right**

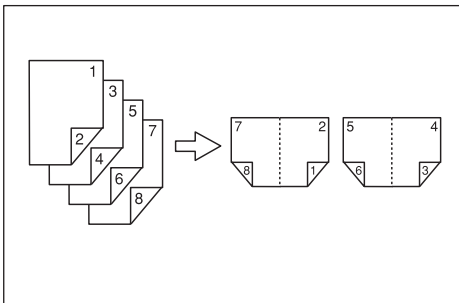

How to fold and unfold copies to make a booklet

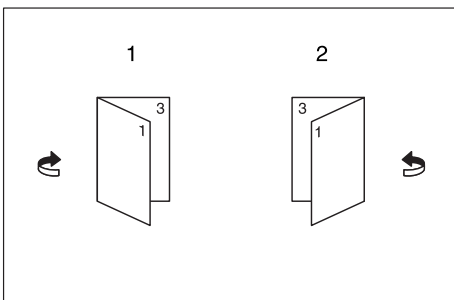

1. Open to left
2. Open to right

How to fold and unfold copies to make a magazine

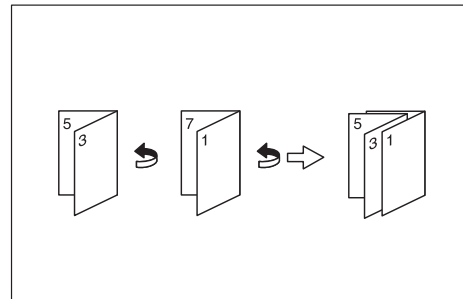
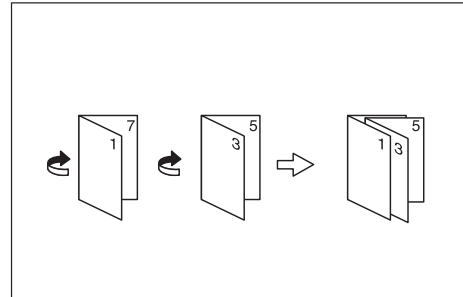

Note

- r You cannot use the bypass tray with this function.
- r The machine sets the reproduction ratio automatically to meet the paper size.

Reference

Related initial settings

p.96 "Erase Original Shadow in Combine"

- 1** Select "Open to left" or "Open to right" with User Tools.

Reference

p.98 "Orientation: Booklet, Magazine"

- 2** Press [Dup./Combine/Series].
- 3** Press [Series/Book].
- 4** Press [Book].

5 Select [1 Sided→Booklet], [2 Sided→Booklet], [1 Sided→Magazine] or [2 Sided→Magazine], and then press [OK].

6 Press [OK].

7 Select the paper.

8 Place your originals, and then press the [Start] key.

Note

r When placing an original on the exposure glass or in the ADF using Batch mode, press the [#] key after all the originals have been scanned.

Image Repeat

The original image is copied repeatedly.

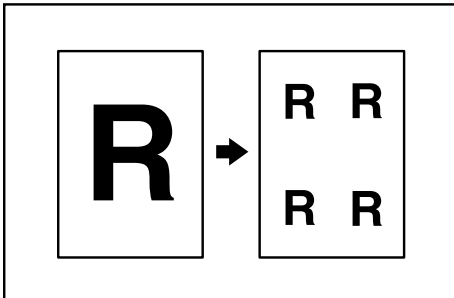

Note

r The number of repeated images depends on the original size, copy paper size, and reproduction ratio. For example, see the following table:

√ Original: A5 / Copy paper: A4 or Original: A5 / Copy paper A4

4 repeats (71%)	16 repeats (35%)

√ Original: A5 / Copy paper: A4 or Original: A5 / Copy paper A4

2 repeats (100%)	8 repeats (50%)	32 repeats (25%)

Reference

Related initial settings

p.96 "Image Repeat Separation Line"

1 Select the size of the copy paper and the reproduction ratio.

2 Press [Edit/Stamp].

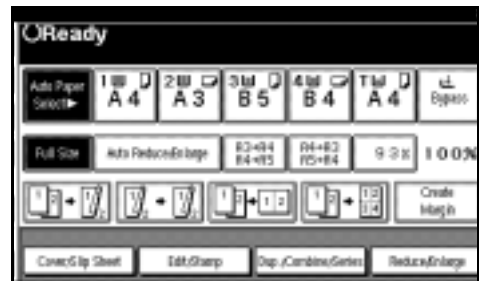

3 Press [Edit Image].

4 Press [Image Repeat].

- 5** Press [OK].
- 6** Press [OK].
- 7** Place your original, and then press the [Start] key.

Double Copies

One original image is copied twice on one copy as shown.

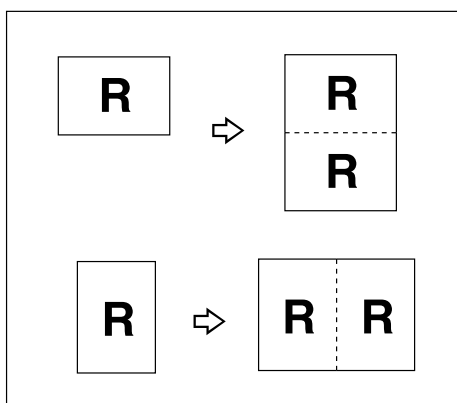

Note

- r You cannot use the bypass tray with this function.
- r See the following table for original and copy paper sizes when using a 100% ratio:

v Metric version

Original size and orientation	Copy paper size and orientation
A5	A4
B6 JIS	B5 JIS
A4	A3
A5	A4
B6 JIS	B5 JIS

v Inch version

Original size and orientation	Copy paper size and orientation
5 ¹ / ₂ " × 8 ¹ / ₂ "	8 ¹ / ₂ " × 11"
5 ¹ / ₂ " × 8 ¹ / ₂ "	8 ¹ / ₂ " × 11"
8 ¹ / ₂ " × 11"	11" × 17"

- r The originals of size A5, B6 JIS, 5¹/₂" × 8¹/₂" cannot be detected properly on the exposure glass. Be sure to select the copy paper manually or place the originals in the ADF.

Reference

Related initial settings

p.97 "Double Copies Separation Line"

- 1** Press [Edit/Stamp].

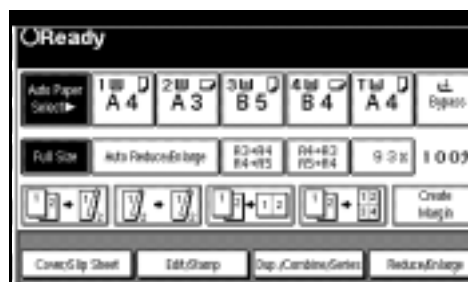

- 2** Press [Edit Image].
- 3** Press [Double Copies].
- 4** Press [OK].
- 5** Press [OK].
- 6** Select the paper.
- 7** Place your originals, and then press the [Start] key.

Centring

You can make copies with the image moved to the centre.

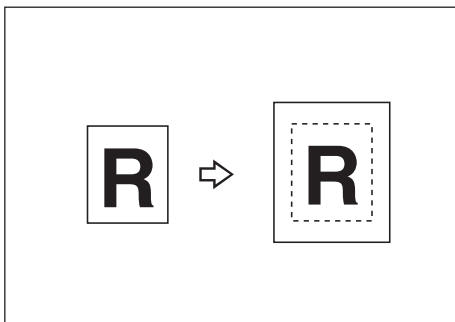

2

Note

- r You cannot use the bypass tray with this function.
- r The original sizes and orientations for centring are listed below.

v Metric version

Original placed on:	Original size and orientation
Exposure glass	A3☐, B4 JIS☐, A4☐☐, B5 JIS☐☐
ADF	A3☐, B4 JIS☐, A4☐☐, B5 JIS☐☐, A5☐☐, B6 JIS☐☐, 11" × 17"☐

v Inch version

Original placed on:	Original size and orientation
Exposure glass	11" × 17"☐, 8½" × 14"☐, 8½" × 11"☐☐
ADF	A3☐, A4☐☐, 11" × 17"☐, 8½" × 14"☐, 8½" × 11"☐, 5½" × 8½"☐☐

1 Select the paper.

2 Press [Edit/Stamp].

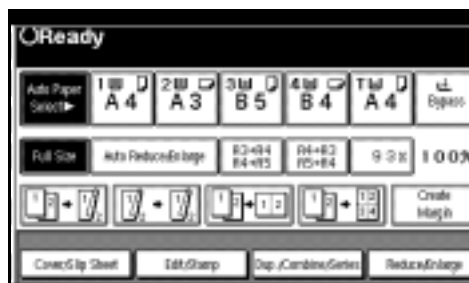

3 Press [Edit Image].

4 Press [Centring].

5 Press [OK].

6 Press [OK].

7 Place your originals, and then press the [Start] key.

Positive/Negative

If your original is black and white, copy images are inverted.

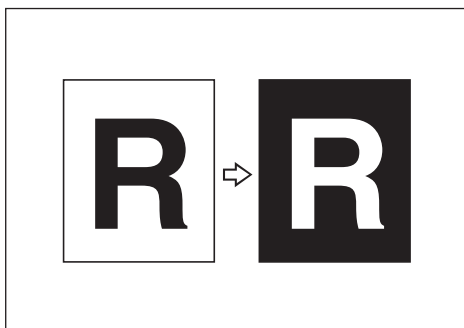

1 Press [Edit/Stamp].

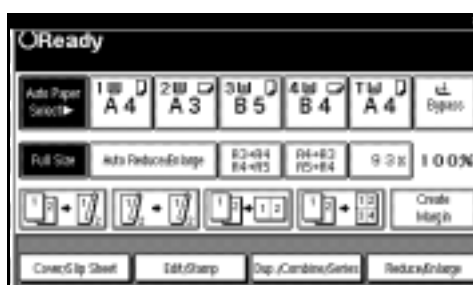

2 Press [Edit Image].

3 Press [Positive/Negative].

4 Press [OK].

5 Press [OK].

6 Select the paper.

7 Place your originals, and then press the [Start] key.

Erase

This function erases the centre and/or all four sides of the original image.

This function has the following three types:

v Border

This mode erases the edge margin of the original image.

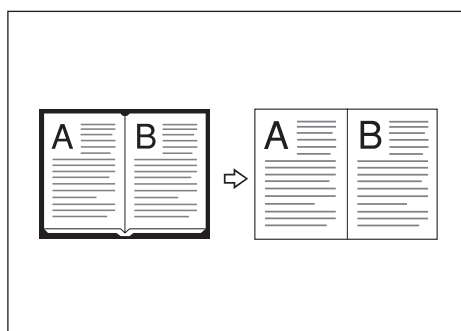

v Centre

This mode erases the centre margin of the original image.

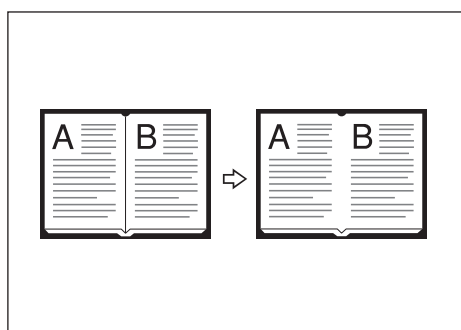

v Centre/Border

This mode erases both the centre and edge margins of the original image.

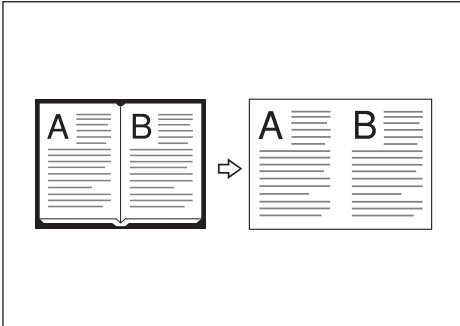

2

Reference

The erase width is set to 10 mm (0.4") as a default. You can change this setting with User Tools.

p.96 "Erase Centre Width"

p.96 "Erase Border Width"

Note

r The relationship between the original orientation and the erased part is as follows:

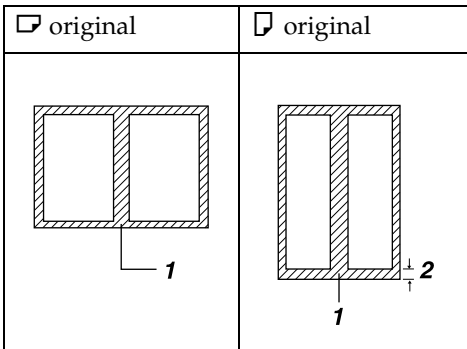

1: Erased part

2: 2–99 mm (0.1"–3.9")

Border Erase

1 Press [Edit/Stamp].

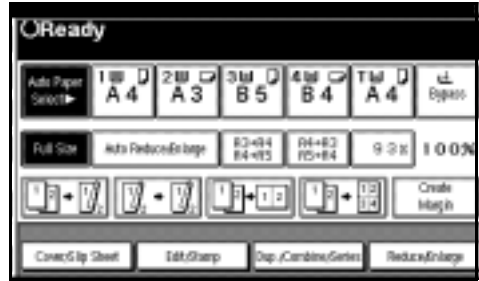

2 Press [Erase].

3 Set the erase border width.

Selecting [Same Width]

A Press [Same Width].



B Set an erase border width with [+] and [-].

Note

r To change the value entered, press [+] and [-] to set the new value.

C Press [OK].

Selecting [Diff. Width]

A Press [Diff. Width].

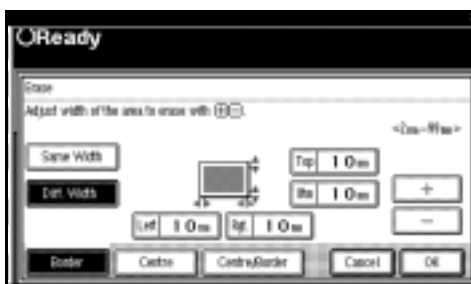

B Press the key for the border you want to change and set an erase border width with [+] and [-].

C Press [OK].

4 Press [OK].

5 Place your originals, and then press the [Start] key.

Centre erase

1 Press [Edit/Stamp].

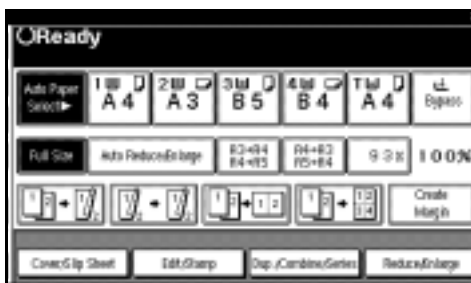

2 Press [Erase].

3 Press [Centre].

4 Set the erase centre width with [+] and [-], and then press [OK].

5 Press [OK].

6 Place your originals, and then press the [Start] key.

Centre/Border erase

1 Press [Edit/Stamp].

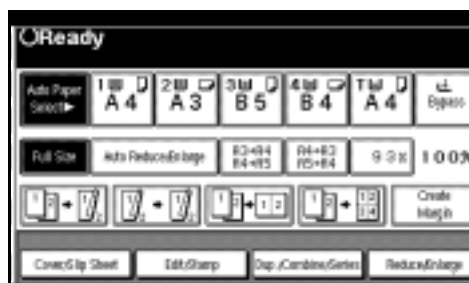

2 Press [Erase].

3 Press [Centre/Border].

4 Set the border to be erased.

Selecting [Same Width]

A Press [Same Width].

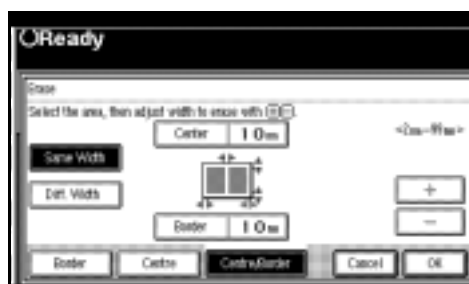

B Press [Centre], and then set the erase centre width with [+] and [-].

C Press [Border], and then set the erase border width with [+] and [-].

D Press [OK].

Selecting [Diff. Width]

A Press [Diff. Width].

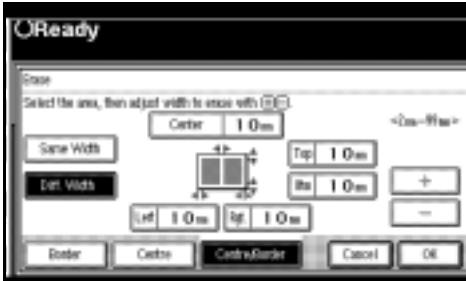

B Press the key for the part you want to change, and then set an erase margin width with [+] and [-].

C Press [OK].

5 Press [OK].

6 Place your originals, and then press the [Start] key.

Margin Adjustment

You can shift the image to the left, right, top, or bottom to make a binding margin.

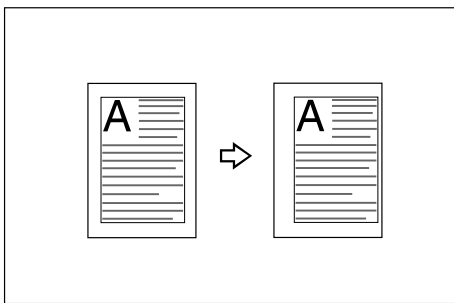

Reference

Related initial settings

p.95 "Front Margin: Left/Right"

p.95 "Back Margin: Left/Right"

p.95 "Front Margin: Top/Bottom"

p.95 "Back Margin: Top/Bottom"

p.96 "1 Sided→2 Sided Auto Margin: TtoT"

Note

r You can change the width of the binding margin as follows:

Metric version	0–30 mm (in increments of 1 mm)
Inch version	0"–1.2" (in increments of 0.1")

1 Press [Edit/Stamp].

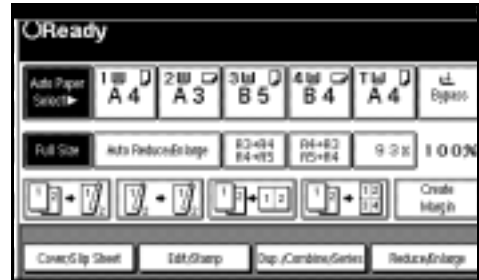

2 Press [Margin Adjustment].

3 Set a binding margin for a front page. Press [←] and [→] when setting the left and right margins, and [↓] and [↑] when setting the top and bottom margins.

Note

r To change the value entered, press [←], [→], [↓], [↑] to set the new value.

r If you do not need to specify the margins for the back side pages, press [OK] and proceed to step 5.

4 Set a binding margin for the back side pages. Press [←] and [→] when setting the left and right margins, and [↓] and [↑] when setting the top and bottom margins, and then press [OK].

Note

r Margin on the back side of the page is valid only when [2 Sided] or [Combine 2 Side] is selected.

5 Press [OK].

- 6** Press [OK].
- 7** Place your originals, and then press the [Start] key.

Background Numbering

Use this function to have numbers printed on the background of copies. It can help you to keep track of confidential documents.

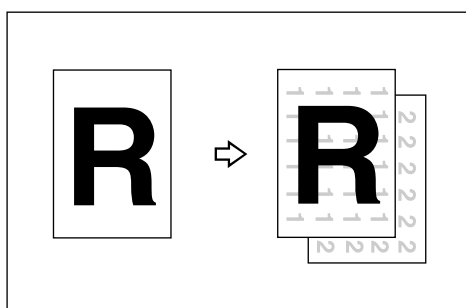

 **Note**

r You can enter a number between 1 and 999.

 **Reference**

Related initial settings

p.98 "Size"

p.98 "Density"

- 1** Press [Edit/Stamp].

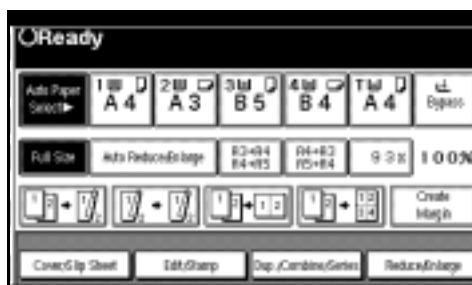

- 2** Press [Stamp].
- 3** Press [Background Numbering].

- 4** Enter the number to start counting from with the number keys, and then press [OK].

- 5** Press [OK].

- 6** Press [OK].

- 7** Place your originals, and then press the [Start] key.

Preset Stamp

Messages used frequently can be stored in memory and stamped on copies.

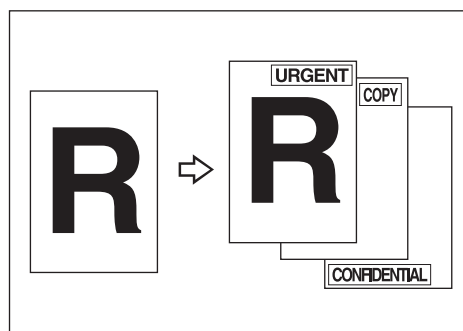

One of the following eight messages can be stamped on copies with a frame around it: "COPY", "URGENT", "PRIORITY", "For Your Info.", "PRELIMINARY", "For Internal Use Only", "CONFIDENTIAL", "DRAFT".

Stamp position and original orientation

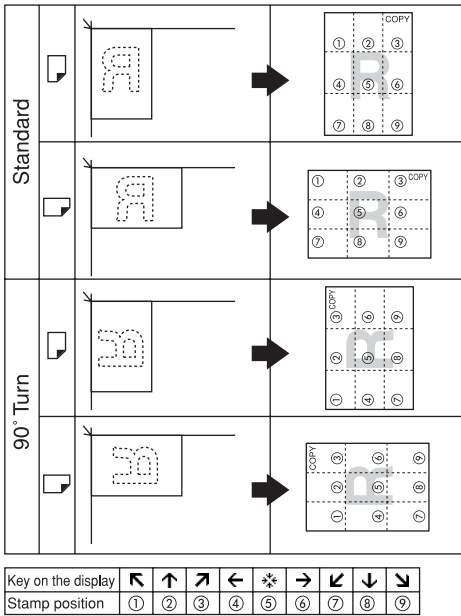

Note

- r You cannot use the bypass tray with this function.
- r Only one message can be stamped each time.

Reference

- p.98 "Stamp Language"
- p.98 "Stamp Position"
- p.99 "Stamp Format"

1 Press [Edit/Stamp].

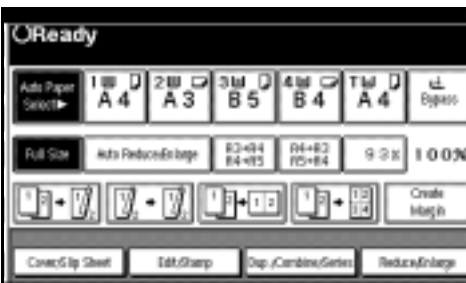

2 Press [Stamp].

3 Press [Preset Stamp].

4 Select the desired message.

5 Press [All Pages] or [1st Page only] to select the print page.

Note

- r You can change the position, size, and density of the stamp. See p.60 "Changing the stamp position, size and density".

6 After you specify all desired settings, press [OK].

7 Press [OK].

8 Place your originals, and then press the [Start] key.

Changing the stamp position, size and density

1 Press [Change].

2 Select the position for print, size, and density, and then press [OK].

User Stamp

Copies with the registered stamp.

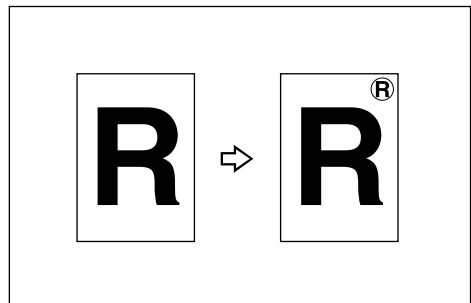

Preparation

You have to register a user stamp before using this function. See p.61 "To program the user stamp".

Stamp position and original orientation

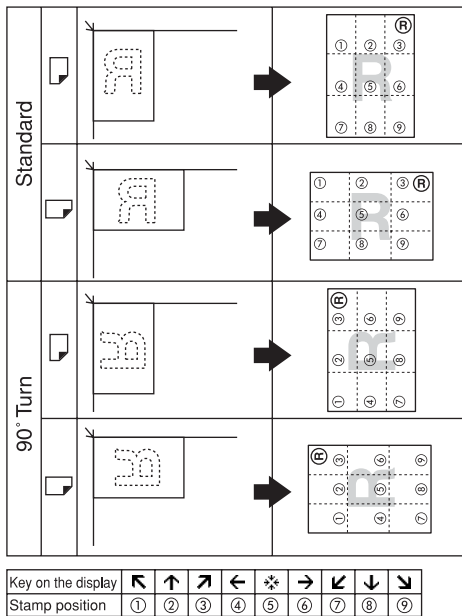

Note

- r You cannot use the bypass tray with this function.
- r Only one message can be stamped each time.

Reference

- Related initial settings
- p.99 "Stamp Position 1 - 4"
- p.99 "Stamp Format 1 - 4"

1 Press [Edit/Stamp].

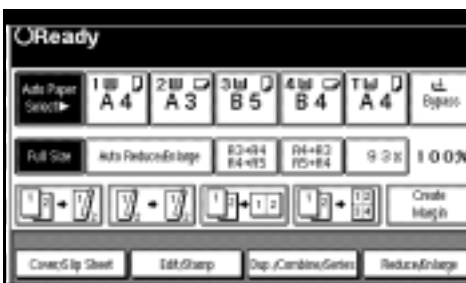

2 Press [Stamp].

3 Press [User Stamp].

4 Select the stamp you require.

5 Press [All Pages] or [1st Page only] to select the print page.

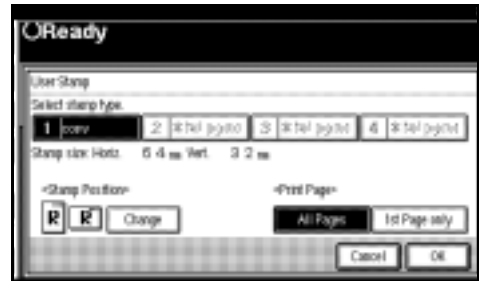

Note

- r You can change the stamp position. See p.61 "To change the stamp position".

6 After making all settings, press [OK].

7 Press [OK].

8 Place your originals, and then press the [Start] key.

To change the stamp position

1 Press [Change].

2 Select the desired position, and then press [OK].

To program the user stamp

Note

- r The range of stamp images for readability is 10–297 mm high (0.4"–11.7") and 10–432 mm (0.4"–17") wide. However, if the value exceeds the maximum value of the area (5,000 mm², 7.75 inch²), it is corrected within the range of the area automatically.

- r Up to four images that you use frequently can be stored in the machine's memory.

1 Make sure that the machine is in copier mode.

2 Press the [User Tools/Counter] key.



3 Press [Copier/Document Server Features].



4 Press [Stamp].

5 Press [User Stamp].

6 Press [Program/Delete Stamp].

7 Press [Program], and then press the stamp number (1–4) you want to program.

Note

- r Stamp numbers with  already have settings in them.
- r If the stamp number is already being used, the machine will ask you if you want to overwrite it. Press [Yes] or [No].

8 Enter the user stamp name with the letter keys on the display panel. You can register up to 10 characters.

9 Press [OK].

Reference

“Entering Text”, *General Settings Guide*

10 Enter the horizontal size of the stamp with the number keys, and then press [#].

11 Press [Vertical], and then enter the vertical size in the same way as step 10.

12 Place the original for user stamp on the exposure glass, and then press [Start Scanning].

The original will be scanned, and the stamp will be registered.

Note

- r Originals cannot be scanned from the ADF when programming the user stamp.

13 Press [Exit].

14 Press [Exit].

The display returns to the Copier/Document Server Features main menu.

15 Press [Exit].

Exits settings and gets ready to copy.

To delete the user stamp

Important

- r You cannot restore a deleted stamp.

1 Make sure that the machine is in copier mode.

2 Press the [User Tools/Counter] key.



3 Press [Copier/Document Server Features].



4 Press [Stamp].

5 Press [User Stamp].

6 Press [Program/Delete Stamp].

7 Press [Delete], and then press the stamp number you want to delete.

8 Select [Delete], and then press [Exit].

9 Press [Exit].

The display returns to the Copier/Document Server Features main menu.

10 Press [Exit].

Exits settings and gets ready to copy.

Date Stamp

Use this function to print dates on your copies.

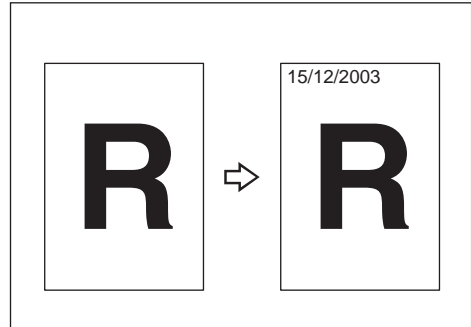

You can select from the following styles:

- MM/DD/YYYY
- MM.DD.YYYY
- DD/MM/YYYY
- DD.MM.YYYY
- YYYY.MM.DD

Stamp position and original orientation

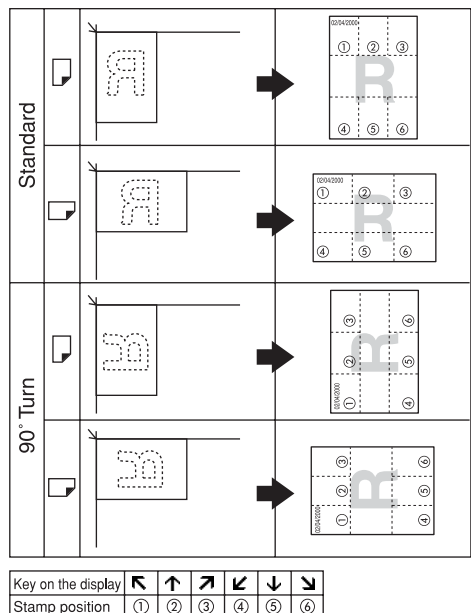

Note

You cannot use the bypass tray with this function.

Reference

Related initial settings

p.100 "Font"

p.100 "Size"

p.100 "Superimpose"

p.100 "Stamp Position"

"Timer Settings", *General Settings Guide*

1 Press [Edit/Stamp].

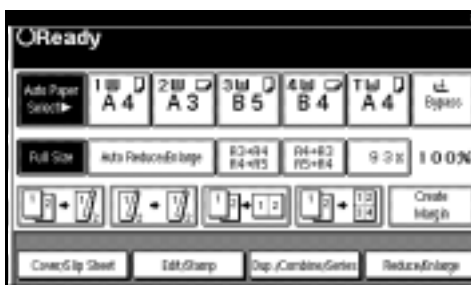

2 Press [Stamp].

3 Press [Date Stamp].

4 Press [All Pages] or [1st Page only] to select the print page.

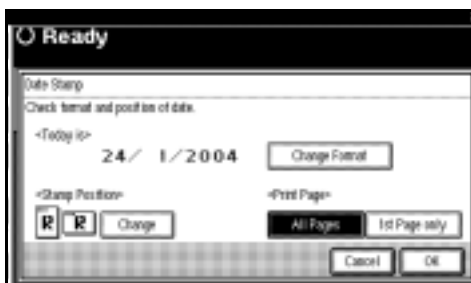

Note

You can change the font and position of the date to be stamped. See p.64 "To change the style of date".

5 After all settings are complete, press [OK].

6 Press [OK].

7 Place your originals, and then press the [Start] key.

To change the style of date

1 Press [Change Format].

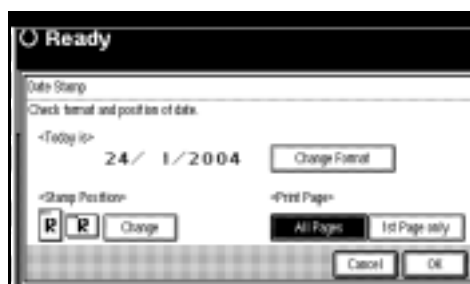

2 Select the date format, and then press [OK].

To change the stamp position

1 Press [Change].

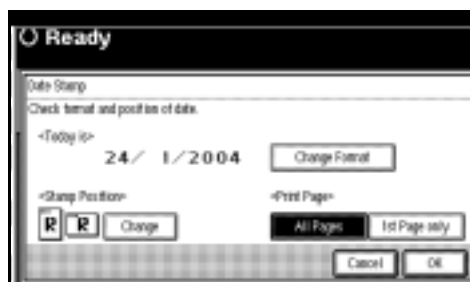

2 Select the desired date stamp position, and then press [OK].

Page Numbering

Use this function to print page numbers on your copies.

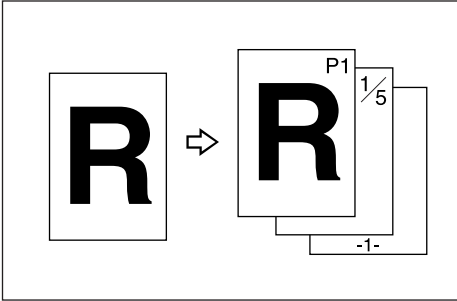

There are six types of Page Numbering (n is the total number of pages in your original):

- P1, P2,...Pn
- 1/n, 2/n,...n/n
- -1-, -2-,...-n-
- P.1, P.2 ...P.n
- 1, 2...n
- 1-1, 1-2,..1-n

Stamp position and original orientation

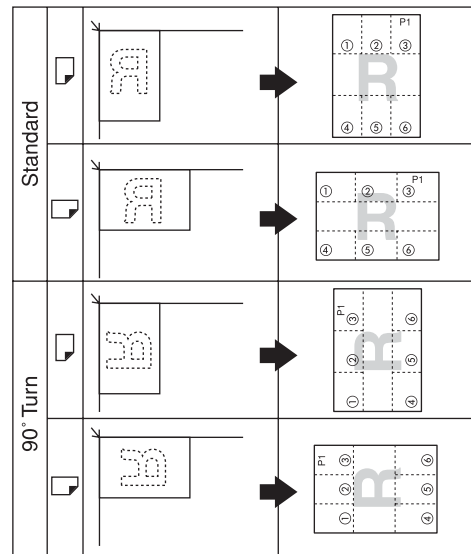

Key on the display						
Stamp position	①	②	③	④	⑤	⑥

Note

You cannot use the bypass tray with this function.

Reference

Related initial settings

p.100 "Font"

p.100 "Size"

p.101 "Superimpose"

p.100 "Stamp Format"

p.100 "Duplex Back Page Stamping Position"

p.101 "Stamp Position"

p.100 "Stamp on Designating Slip Sheet"

- 1 Press [Edit/Stamp].

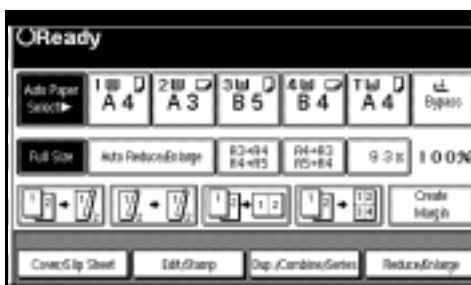

- 2 Press [Stamp].

- 3 Press [Page Numbering].

- 4 Select the format.

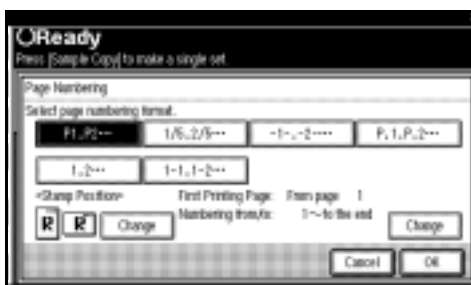

Note

- r You can specify the stamp position, pages to be stamped, and numbering. See p.66 “Changing the stamp position” and p.66 “Specifying the first printing page and start number”.

- 5 After you specify all desired settings, press [OK].

- 6 Press [OK].

- 7 Place the originals, and then press the [Start] key.

Changing the stamp position

- 1 Press [Change].

- 2 Select the desired position, and then press [OK].

Specifying the first printing page and start number

If you selected (P1, P2..., -1-, -2-..., P.1, P.2..., 1, 2...,)

Note

- r Below explains the example when (P1, P2...) is selected. The steps are the same for other cases.

- 1 Press [Change] on the right side.

- 2 Press [First Printing Page], enter the original sheet number from which to start printing, and then press the [#] key.



Note

- r To change the number entered, press [Clear] or the [Clear/Stop] key, and then enter a new number.

- 3 Press [Numbering from/to], enter the number of the page from which to start numbering with the number keys, and then press the [#] key.

Note

- The example below shows when the first printing page is "2" and the start number is "3".

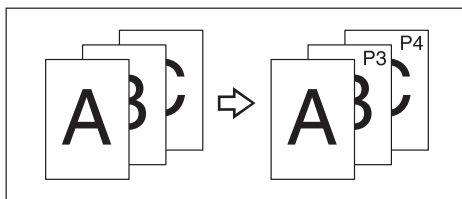

- Press **[Last Number]**, enter the number of the page at which to stop numbering with the number keys, and then press the **[#]** key.

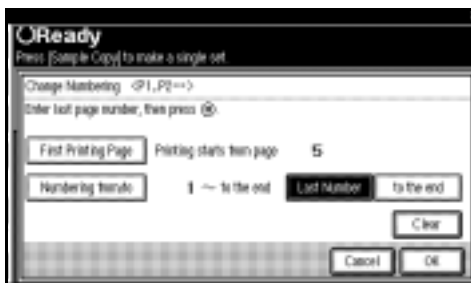
**Note**

- If you want to number all pages to the end, press **[to the end]**.

- When page designation is complete, press **[OK]**.

- Press **[OK]**.

If you selected (1/5, 2/5...)

- Press **[Change]** on the right side.

- Press **[First Printing Page]**, enter the original sheet number from which to start printing, and then press the **[#]** key.

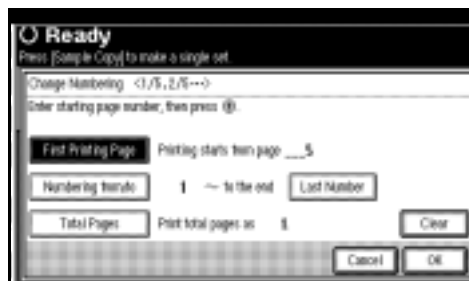
**Note**

- You can enter between 1 and 9999 for the original sheet number from which to start printing.
- To change the number entered, press **[Clear]** or the **[Clear/Stop]** key, and then enter a new number.

- Press **[Numbering from/to]**, enter the number of page from which to start numbering with the number keys, and then press the **[#]** key.

- Press **[Last Number]**, enter the number of page at which to stop numbering with the number keys, and then press the **[#]** key.

Proceed to step **5** when not changing .

Note

- If you want to number all pages to the end, press **[to the end]**.
- The last number is the last page number to print. For example, if **[Total Pages]** is ten, if you want to print up to seven pages and do not want to print from page 8 on, enter **[7]** for **[Last Number]**. Normally, you do not need to enter the number.

5 Press **[Total Pages]**, enter the total number of original pages with the number keys, and then press the **[#]** key.

6 When page designation is complete, press **[OK]**.

 **Note**

r To change the settings after pressing **[OK]**, press **[Change]**, and then enter the numbers again.

If you selected (1-1, 1-2,...)

1 Press **[Change]** on the right side.

2 Press **[First Printing Page]**, enter the original sheet number from which to start printing, and then press the **[#]** key.

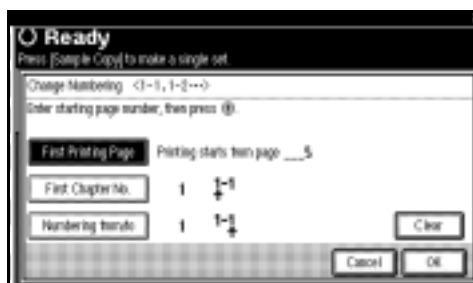

 **Note**

r To change the number entered, press **[Clear]** or the **[Clear/Stop]** key, and then enter a new number.

3 Press **[First Chapter No.]**, enter the chapter number from which to start numbering with the number keys, and then press the **[#]** key.

 **Note**

r You can enter between 1 and 9999 for the chapter number from which to start numbering.

4 Press **[Numbering from/to]**, enter the page number from which to start printing with the number keys, and then press the **[#]** key.

5 Press **[OK]**.

6 When page designation is complete, press **[OK]**.

Covers

Using this function, you can create cover sheets by adding additional pages of different paper or copying existing pages on different paper.

 **Preparation**

Before selecting this function, set the tray for the front cover paper. See "Cover Sheet Tray" in "Tray Paper Settings", *General Settings Guide*.

 **Note**

- r The cover sheet should be the same size and orientation as the copy paper.
- r You cannot place the copy paper in the bypass tray.
- r When selecting **[Copy]**, select whether the front and back covers are copied one-sided or two-sided. See "Cover Sheet Tray" in "Tray Paper Settings", *General Settings Guide*.

v **Front cover**

The first page of your originals is copied on specific paper sheet for covers, or a cover sheet is inserted before the first copy.

- Copy

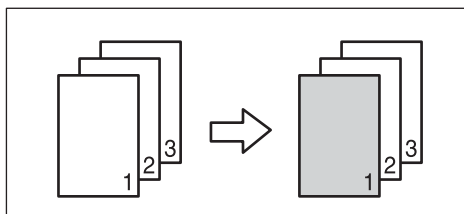

- Blank

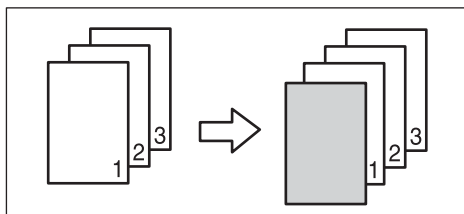

v **Front/Back covers**

The first and last pages of your original are copied on specific paper for use as covers.

- Copy

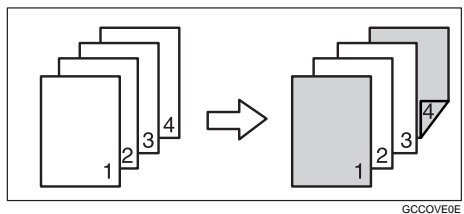

GCCOVE0E

- Blank

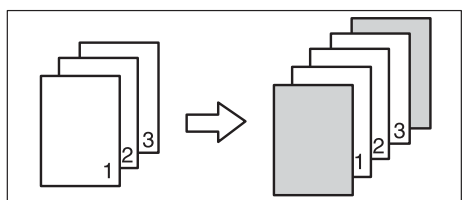

Reference

p.97 “Front Cover Copy in Combine”

1 Press [Cover/Slip Sheet].

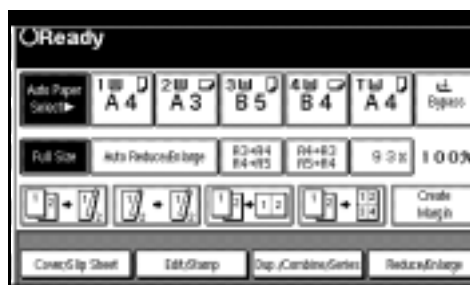

2 Press [Front Cover] or [Front/Back Cover].

3 Select [Copy] or [Blank] for the cover sheet.

4 Select the paper tray that contains the sheet paper to copy the originals, and then press [OK].

5 Place your originals in the ADF, and then press the [Start] key.

Designate

Use this function to have certain pages of your original copied onto slip sheets.

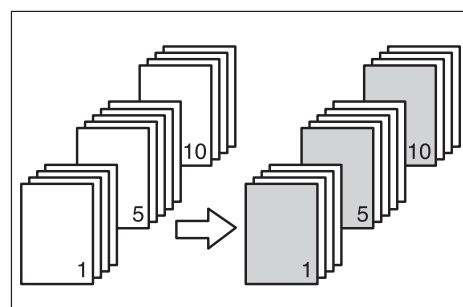

Preparation

Before using this function, set the special paper tray for slip sheets. See “Cover Sheet Tray” and “Slip Sheet Tray” in “Tray Paper Settings”, *General Settings Guide*.

Note

- r The slip sheets should be the same size and orientation as the copy paper.
- r You cannot place the copy paper in the bypass tray.
- r You can specify the pages up to 20.

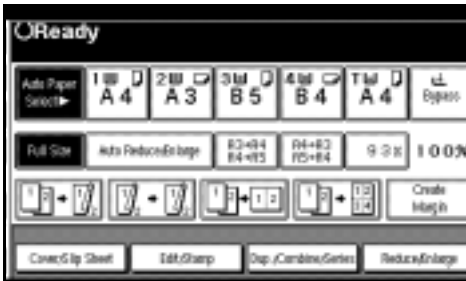
1 Press [Cover/Slip Sheet].**2** Press [Desig./Chapter].**3** Press the key to select the chapter number.**4** Enter the page number of the original's location you want to copy onto a slip sheet with the number keys, and then press the [#] key.**5** Select the paper tray for slip sheets.**6** To specify another page location, repeat steps **3** to **5**.**Note**

- r To select chapters 11 to 20, press the [▼11~20] key.

7 When page designation is complete, press [OK].**8** Press [OK].**9** Select the paper tray that contains the sheet paper to copy the originals.**10** Place your originals in the ADF, and then press the [Start] key.

Chapter

The page locations you specify with this function will appear on the front of copy sheets.

Preparation

Before selecting this function, press [Dup./Combine/Series] and select Duplex (1 Sided→2 Sided) mode or Combine mode.

Note

- r This function can be used only when you use the Duplex (1 Sided→2 Sided) or Combine function.
- r You can specify the pages up to 20.

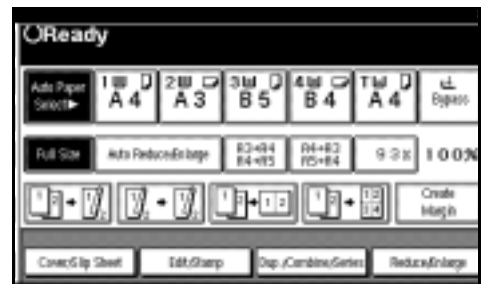
1 Press [Cover/Slip Sheet].**2** Press [Desig./Chapter].**3** Press [Chapter].**4** Press the key to select the chapter number.**5** Enter the page location of the first page of the first chapter with the number keys, and then press the [#] key.**6** To specify another page location, repeat steps **4** to **5**.**Note**

- r To select chapters 11 to 20, press the [▼11~20] key.

7 When page designation is complete, press [OK].

8 Place your originals, and then press the [Start] key.

Slip Sheets

Using this function, you can insert a slip sheet between OHP transparencies or stacks. You can also print on the inserted slip sheet.

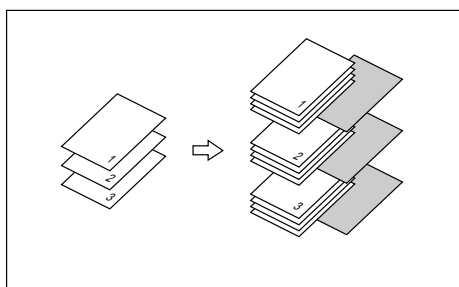

Preparation

Before selecting this function, specify the paper tray for slip sheets. See "Slip Sheet Tray" in "Tray Paper Settings", *General Settings Guide*.

Note

Load the slip sheets in the same size and orientation as the copy paper or the OHP transparency.

When using OHP transparencies placed in the bypass tray

- Copy

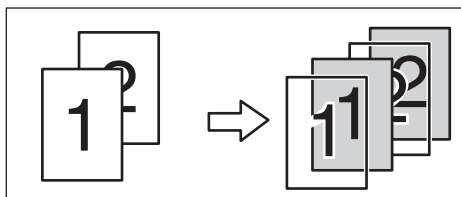

- Blank

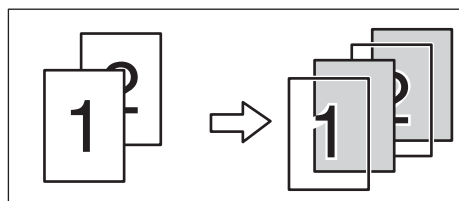

Note

Press the [#] key and select [OHP Sheet] in Special paper. See p.20 "When copying onto special paper".

1 Press [Cover/Slip Sheet].

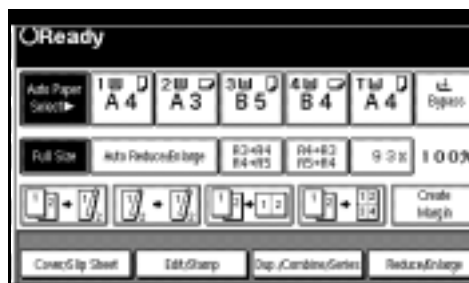

2 Press [Slip Sheet].

3 Select [Copy] or [Blank], and then press [OK].

4 Select the paper tray containing the sheet paper to copy the originals.

5 Place the originals, and then press the [Start] key.

Storing Data in the Document Server

The Document Server enables you to store documents in the memory and print them as you want.

Important

Data stored in the machine might be lost if some kind of failure occurs. The manufacturer shall not be responsible for any damage that might result from the loss of data.

Note

Data stored in the Document Server is set to be deleted after three days by the factory default. You can specify the period after which the stored data is deleted automatically. For more information about settings, see “Auto Delete File” in “Key Operator Tools”, *General Settings Guide*.

1 Press [Store File].

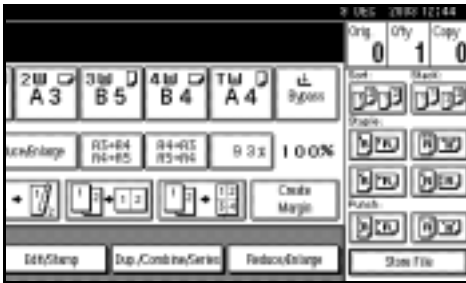

2 Enter a file name, user name, or password if necessary.

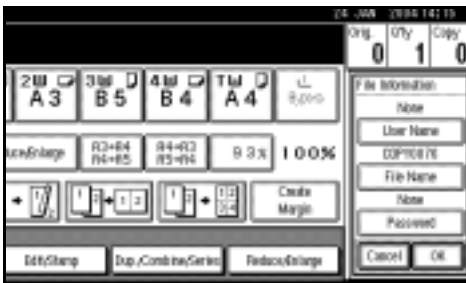

Reference

For details about how to register the file name, user name or password, see *General Settings Guide*.

3 Press [OK].

4 Place the originals.

Reference

For more information about the types of originals that can be placed and how to place them, see p.10 “Placing Originals”.

5 Make the scanning settings for the original.



6 Press the [Start] key.

Originals are scanned and stored in memory.

Note

To stop scanning, press the [Clear/Stop] key. To resume a paused scanning job, press [Continue] in the confirmation display. To delete scanned images and cancel the job, press [Stop]. The originals placed in the ADF are delivered.

When placing an original on the exposure glass, press the [#] key after all the originals have been scanned.

To check if the document has been stored, press the [Document Server] key.

Programs

You can store frequently used copy job settings in the machine memory and recall them for future use.

Storing a Program

Note

- r You can store up to 10 programs.
- r You can select the standard mode or program No. 10 as the mode to be set when modes are cleared or reset, or immediately after the operation switch is turned on. See p.92 “Change Initial Mode”.
- r Paper settings are stored based on paper size. So if you place more than one paper tray of the same size, the paper tray prioritized with User Tools (System Settings) will be selected first. See “Paper Tray Priority” in “Tray Paper Settings”, *General Settings Guide*.
- r Programs are not deleted by turning the power off or by pressing the **[Clear Modes]** key. They are canceled only when you delete or overwrite them with another program.

1 Edit the copy settings so all functions you want to store in this program are selected.

2 Press the **[Program]** key.

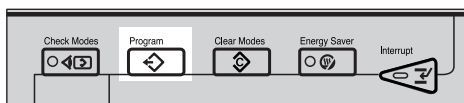

3 Press **[Register]**.

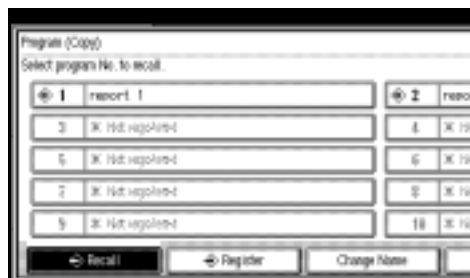

4 Press the program number you want to store.

Note

- r Program numbers with  against them already have settings in them.

Reference

p.74 “Changing a Stored Program”

5 Enter the program name with the letter keys on the display panel.

You can enter up to 40 characters.

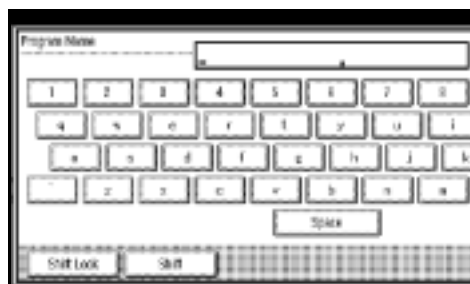

Reference

For details about entering characters, see “Entering Text”, *General Settings Guide*.

Note

- r If you do not want to enter the program name, proceed to step **6**.

6 Press [OK].

When the settings are successfully stored,  appears on the left side and the program name appears on the right side of the registered program number. The display returns to the initial copy display for a while.

Changing a Stored Program

1 Check the program settings.

 **Note**

r When you want to check the contents of a program, recall the program. See p.74 “Recalling a Program”.

2 Repeat steps **1** to **4** of “Storing a Program”.

3 Press [Register].

Repeat steps **5**, **6** of “Storing a Program”.

 **Note**

r When it is overwritten, the previous program is deleted.

Deleting a Program

1 Press the [Program] key.

2 Press [Delete].



3 Press the program number you want to delete.

4 Press [Yes].

The program is deleted, and the display returns to the initial copy display.

Recalling a Program

1 Press the [Program] key.

2 Press [Recall].



3 Press the program number you want to recall.

The stored settings are displayed.

 **Note**

r Program numbers with  against them already have settings in them.

4 Place the originals, and then press the [Start] key.

3. Troubleshooting

If Your Machine Does Not Operate As You Want

When a Message Is Displayed

The following chart contains explanations for the common messages. If other messages appear, follow the instructions as they are displayed.

 **Note**

r For messages that are not listed here, see *General Settings Guide*.

Message	Causes	Solutions
Cannot detect original size.	Improper original is placed. See p.9 "Sizes difficult to detect".	Select paper manually, not in Auto Paper Select mode, and do not use Auto Reduce/Enlarge function. Place the original on the exposure glass. See p.11 "Placing Originals on the Exposure Glass".
	Original is not placed.	Place your originals.
Check original orientation.	Original is not placed in a proper orientation.	Change the orientation of the original.
Check paper size.	Improper paper size is set.	If you press the [Start] key, copy will start onto the selected paper.
Rotate Sort is not available with this image size.	A size of paper for which Rotate Sort is not available is selected.	Select the proper paper size. See p.31 "Sort".
Cannot punch paper of this size.	The Punch function cannot be used with paper size selected.	The following paper sizes are available for Punch mode: A3, B4 JIS, A4, B5 JIS, A5, 11"x17", 8 ¹ / ₂ "x14" and 5 ¹ / ₂ "x8 ¹ / ₂ ". Select one of these sizes.
It is over stapling capacity.	The number of sheets per set is over the staple capacity.	Check the stapler capacity. See p.108 "Staple".
Cannot staple paper of this size.	The Staple function cannot be used with paper size selected.	Select a paper size that can be used in Staple mode. See p.108 "Staple".

Message	Causes	Solutions
Duplex is not available with this paper size.	A paper size not available in Duplex mode has been selected.	The following paper sizes are available for Duplex mode: A3, B4 JIS, A4, B5 JIS, A5. Select one of these sizes.
Maximum number of sets is *.	The number of copies exceeds the maximum copy quantity.	You can change the maximum copy quantity. See p.92 "Max. Copy Quantity".
Original is being scanned by another function.	The Document Server function is in use.	To cancel the job in process, press [Exit] , and then press the [Document Server] key. Next, press the [Clear/Stop] key. When the message "[Stop] key was pressed. Stop storing?" appears, press [Stop] .

If You Cannot Make Clear Copies

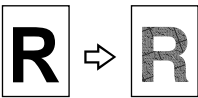

Problem	Causes	Solutions
Copies appear dirty.	Image density is too dark.	Adjust the image density. See p.21 "Adjusting Image Density".
	Auto Image Density is not selected.	Adjust the auto density. See p.21 "Adjusting Image Density".
The reverse side of an original image is copied.	Image density is too dark.	Adjust the image density. See p.21 "Adjusting Image Density".
	Auto Image Density is not selected.	Adjust the auto density. See p.21 "Adjusting Image Density".
A shadow appears on copies if you use pasted originals.	Image density is too dark.	Adjust the image density. See p.21 "Adjusting Image Density". Change the orientation of the original. Put mending tape on the pasted part.
The same copy area is dirty whenever making copies.	The exposure glass or ADF is dirty.	Clean them. See <i>General Settings Guide</i> .
Copies are too light.	Image density is too light.	Adjust the image density. See p.21 "Adjusting Image Density".
	The paper size is not appropriate.	Use the recommended paper. Note A light copy may result when you use damp or rough grain paper.
	Toner bottle is almost empty.	Add toner. See <i>General Settings Guide</i> .
Parts of the image are not copied.	The original is not set correctly.	Set originals correctly. See p.10 "Placing Originals".
	An improper paper size is selected.	Select the proper paper size.
Copies are blank.	The original is not set correctly.	When using the exposure glass, face the originals down. When using the ADF, face them up. See p.10 "Placing Originals".
A moiré pattern is produced on copies. 	Your original has a dot pattern image or many lines.	Place the original on the exposure glass at a slight angle.

If You Cannot Make Copies As You Want

This section explains causes and remedies when copy results are not as expected.

v Basic

3

Problem	Causes	Solutions
Copies are not stapled.	There are jammed staples in the stapler.	Remove jammed staples. See <i>General Settings Guide</i> .  Note r After removing jammed staples, staples might not be ejected the first few times you try to use the stapler.
	The number of copies exceeds the capacity of the stapler.	Check the stapler capacity. See p.108 "Staple".
	Copy paper is curled.	Turn the copy paper over in the tray.
Staples are wrongly positioned.	Originals are not set correctly.	Check the correct position to place the originals. See p.35 "Staple".
You cannot combine several functions.	Selected functions cannot be used together.	Check the combination of functions and make the settings again.  Reference p.103 "Combination Chart"
When sorting, the pages are divided into two blocks.	The memory became full in the middle of sorting and the pages were delivered in two blocks.	You can interrupt copying when the memory becomes full. See p.101 "Memory Full Auto Scan Restart".
Paper does not output during printing with stapling.	When you stop printing while using the staple function, papers not stapled during printing may be left in the staple unit.	Press the [Reset] key and cancel copy settings, including stapling.

v **Edit**

Problem	Causes	Solutions
In Double Copies mode, parts of the original image are not copied.	Combination of original and copy paper is not correct.	Select A3 <input type="checkbox"/> for A4 <input type="checkbox"/> originals and A4 for A5 originals.
In Border, Centre, or Centre/Border mode, parts of the original image are not copied.	You set a wide erased margin.	Make the margin width narrower. You can adjust it between 2–99 mm (0.1"–3.9"). See p.96 "Erase Border Width" and p.96 "Erase Centre Width".
	Originals are not scanned correctly.	Place the originals correctly.
In Margin Adjustment mode, parts of the original image are not copied.	You set a wide erased margin.	Set a narrower margin with User Tools. You can set the width between 0–30 mm (0"–1.2"). See p.95 "Front Margin: Left/Right", p.95 "Front Margin: Top/Bottom", p.95 "Back Margin: Left/Right", and p.95 "Back Margin: Top/Bottom".
	There is a lack of margin space on the opposite side of the binding position.	
In Image Repeat mode, the original image is not copied repeatedly.	You selected copy paper the same size as the originals, or you did not select the proper reproduction ratio.	Select copy paper larger than the originals.
		Select the proper reproduction ratio.

v **Stamp**

Problem	Causes	Solutions
The stamp position is wrong.	The paper orientation is wrong.	Check the paper orientation and stamp position.

v **Combine**

Problem	Causes	Solutions
You cannot make a book from Booklet or Magazine mode by folding copies.	You selected a setting (“Open to left” or “Open to right”) that does not match the orientation of originals.	Change the setting.
When using Combine, parts of the image are not copied.	You specified a reproduction ratio that does not match the sizes of your originals and copy paper.	When you specify a reproduction ratio using Manual Paper Select mode, make sure that the ratio matches your originals and the copy paper.  Note r Select the correct reproduction ratio before using Combine mode.
Copies are not in correct order.	You placed the originals in the incorrect order.	When placing a stack of originals in the ADF, the last page should be on the bottom.
		If you place an original on the exposure glass, start with the first page to be copied.

v **Duplex**

Problem	Causes	Solutions
When using Duplex, copy is made Top/Bottom even though Left/Right is selected.	You placed the originals in the wrong orientation.	Place the originals in the correct orientation. See p.10 “Original Orientation” .
Copies are not in correct order.	You placed the originals in the incorrect order.	When placing a stack of originals in the ADF, the last page should be on the bottom.
		If you place an original on the exposure glass, start with the first page to be copied.

When Memory Is Full

Note

- r If you set **[Memory Full Auto Scan Restart]** in User Tools (see p.101 “Memory Full Auto Scan Restart”) to **[Yes]**, even if the memory becomes full, the memory overflow message will not be displayed. The machine will make copies of the scanned originals first, then automatically proceed scanning and copying the remaining originals. In this case, the resulting sorted pages will not be sequential.

Messages	Causes	Solutions
<p>Memory is full.* originals have been scanned.</p> <p>Press [Print] to copy scanned originals. Do not remove remaining originals.</p> <p> Note</p> <p>r Copying will stop and this message will be displayed when the memory is full.</p>	<p>The scanned original exceeds the number of pages that can be stored in memory.</p>	<p>Press [Print] to copy scanned originals and cancel the scanning data. Press [Clear] to cancel the scanning data and not copy.</p>
<p>Press [Resume] to scan and copy remaining originals.</p> <p>[Stop] [Resume]</p>	<p>The machine checks if the remaining originals should be copied, after the scanned original has been printed.</p>	<p>To continue copying, remove all copies, and then press [Resume]. To stop copying, press [Stop].</p>

4. User Tools (Copier/Document Server Features)

User Tools Menu (Copier/Document Server Features)

User Tools Item Names	Default
General Features 1/4 (See p.90 "General Features 1/4".)	
Auto Paper Select Priority	ON
Auto Tray Switching	With image rotation
Paper Display	Display
Original Type Priority	Text
Original Type Display	Display
Auto Image Density Priority	Text: On Text/Photo: On Photo: Off Pale: On Generation Copy: On
Copy Quality	Text: Normal Text/Photo: Normal Photo: Print Photo Pale: Normal Generation Copy: Normal
Image Density	Text: Normal Text/Photo: Normal Photo: Normal Pale: Normal Generation Copy: Normal
General Features 2/4 (See p.92 "General Features 2/4".)	
Duplex Mode Priority	1 Sided → 1 Sided (metric) 1 Sided → 2 Sided (inch)
Copy Orientation in Duplex Mode	Top to Top
Original Orientation in Duplex Mode	Top to Top
Change Initial Mode	Standard
Max. Copy Quantity	999 Sheets
Tone: Original remains	ON
Job End Call	ON

User Tools Item Names	Default
General Features 3/4 (See p.93 “General Features ³ / ₄ ”.)	
Copy Function Key: F1–F5	<ul style="list-style-type: none"> • F1: 1 Sided → 2 Sided: T to T • F2: 2 Sided: T to T → 2 Sided: T to T • F3: 1 Sided → 1 Sided Combine • F4: 1 Sided → 1 Sided Combine: 4 originals • F5: Create Margin
General Features 4/4 (See p.93 “General Features ⁴ / ₄ ”.)	
Document Server Storage Key: F1–F5	<ul style="list-style-type: none"> • F1: 2 Sided Original Top to top • F2: 1 Sided → 1 Sided Combine • F3: 1 Sided → 1 Sided Combine: 4 originals • F4: 1 Sided → 1 Sided Combine: 8 originals • F5: Create Margin
Reproduction Ratio 1/2 (See p.94 “Reproduction Ratio ¹ / ₂ ”.)	
Shortcut R/E	<p>Metric version</p> <ul style="list-style-type: none"> • Shortcut R/E 1: 71% • Shortcut R/E 2: 141% • Shortcut R/E 3: 93% <p>Inch version</p> <ul style="list-style-type: none"> • Shortcut R/E 1: 73% • Shortcut R/E 2: 155% • Shortcut R/E 3: 93%
Enlarge 1–5	<p>Metric version</p> <ul style="list-style-type: none"> • Enlarge 1: 115% • Enlarge 2: 122% • Enlarge 3: 141% • Enlarge 4: 200% • Enlarge 5: 400% <p>Inch version</p> <ul style="list-style-type: none"> • Enlarge 1: 121% • Enlarge 2: 129% • Enlarge 3: 155% • Enlarge 4: 200% • Enlarge 5: 400%
Priority Setting: Enlarge	<p>Metric version: 141%</p> <p>Inch version: 155%</p>

User Tools Item Names	Default
Reproduction Ratio 2/2 (See p.94 "Reproduction Ratio $2/2$ ".)	
Reduce 1–6	<p>Metric version</p> <ul style="list-style-type: none"> •Reduce 1: 25% •Reduce 2: 50% •Reduce 3: 65% •Reduce 4: 71% •Reduce 5: 75% •Reduce 6: 82% <p>Inch version</p> <ul style="list-style-type: none"> •Reduce 1: 25% •Reduce 2: 50% •Reduce 3: 65% •Reduce 4: 73% •Reduce 5: 78% •Reduce 6: 85%
Priority Setting: Reduce	Metric version: 71% Inch version: 73%
Ratio for Create Margin	93%
R/E Priority	<i>Reduce</i>
Edit 1/2 (See p.95 "Edit $1/2$ ".)	
Front Margin: Left/Right	Metric version: <i>Left 5 mm</i> Inch version: <i>Left 0.2"</i>
Back Margin: Left/Right	Metric version: <i>Right 5 mm</i> Inch version: <i>Right 0.2"</i>
Front Margin: Top/Bottom	Metric version: <i>T/B 0 mm</i> Inch version: <i>T/B 0"</i>
Back Margin: Top/Bottom	Metric version: <i>T/B 0 mm</i> Inch version: <i>T/B 0"</i>
1 Sided→2 Sided Auto Margin: TtoT	Metric version: <i>Right 5 mm</i> Inch version: <i>Right 0.2"</i>
1 Sided→2 Sided Auto Margin: TtoB	Metric version: <i>T/B 0 mm</i> Inch version: <i>T/B 0"</i>
Erase Border Width	Metric version: <i>10 mm</i> Inch version: <i>0.4"</i>
Erase Original Shadow in Combine	<i>Yes</i>
Erase Centre Width	Metric version: <i>10 mm</i> Inch version: <i>0.4"</i>

User Tools Item Names	Default		
Edit 2/2 (See p.96 "Edit ² /2".)			
Image Repeat Separation Line	None		
Double Copies Separation Line	None		
Separation Line in Combine	None		
Copy on Designating Paper	Yes		
Front Cover Copy in Combine	Combine		
Copy on Designating Page in Combine	Combine		
Orientaion: Booklet, Magazine	Open to Left		
Copy Order in Combine	From left to right		
Stamp (See p.98 "Stamp".)			
Background Numbering	Size	Normal	
	Density	Normal	
Preset Stamp	Stamp Priority	Copy	
	Stamp Language	English	
	Stamp Position	Metric version	<ul style="list-style-type: none"> • Position: <i>Top right</i> • Top Margin: <i>24 mm</i> • Right Margin: <i>24 mm</i>
		Inch version	<ul style="list-style-type: none"> • Position: <i>Top right</i> • Top Margin: <i>1.0"</i> • Right Margin: <i>1.0"</i>
	Stamp Format	Size: 1×	
		Density: Normal	
Page to Stamp: All Pages			
User Stamp	Program/Delete Stamp		
	Stamp Position: 1-4	Metric version	<ul style="list-style-type: none"> • Position: <i>Top right</i> • Top Margin: <i>24 mm</i> • Right Margin: <i>24 mm</i>
		Inch version	<ul style="list-style-type: none"> • Position: <i>Top right</i> • Top Margin: <i>1.0"</i> • Right Margin: <i>1.0"</i>
Stamp Format: 1-4	All Pages		

User Tools Item Names		Default
Date Stamp	Format	Metric version: <i>DD/MM/YYYY</i> Inch version: <i>MM/DD/YYYY</i>
	Font	<i>Font 1</i>
	Stamp Position	Metric version <ul style="list-style-type: none"> • Position: <i>Top left</i> • Top Margin: <i>8 mm</i> • Left Margin: <i>32 mm</i> Inch version <ul style="list-style-type: none"> • Position: <i>Top left</i> • Top Margin: <i>0.3"</i> • Left Margin: <i>0.8"</i>
	Stamp Setting	<i>All Pages</i>
	Size	<i>Auto</i>
	Superimpose	<i>No</i>

User Tools Item Names	Default	
Page Numbering	Stamp Format	<i>P1, P2...</i>
	Font	<i>Font 1</i>
	Size	<i>Auto</i>
	Duplex Back Page Stamping Position	<i>Opposite Position</i>
	Page Numbering in Combine	<i>Per original</i>
	Stamp on Designating Slip Sheet	<i>No</i>
	Stamp Position	Metric version <ul style="list-style-type: none"> • Position P1, 1/5, P.1, 1: <i>Top right</i> -1-, 1-1: <i>Bottom centre</i> • Top/Bottom Margin P1, 1/5, P.1, 1: <i>12 mm</i> -1-, 1-1: <i>8 mm</i> • Left/Right Margin P1, 1/5, P.1, 1: <i>12 mm</i> -1-, 1-1: <i>0 mm</i> Inch version <ul style="list-style-type: none"> • Position P1, 1/5, P.1, 1: <i>Top right</i> -1-, 1-1: <i>Bottom centre</i> • Top/Bottom Margin P1, 1/5, P.1, 1: <i>0.5"</i> -1-, 1-1: <i>0.3"</i> • Left/Right Margin P1, 1/5, P.1, 1: <i>0.5"</i> -1-, 1-1: <i>0.0"</i>
Superimpose	<i>No</i>	
Input/Output (See p.101 "Input/Output".)		
Switch to Batch	<i>Batch</i>	
SADF Auto Reset	<i>5 seconds</i>	
Rotate Sort: Auto Paper Continue	<i>No</i>	
Auto Sort	<i>No</i>	
Memory Full Auto Scan Restart	<i>No</i>	
Select Stack Function	<i>Stack</i>	
Select Stapling Position	<i>Top 2</i>	
Select Punch Type	<i>2 holes</i>	
Letterhead Setting	<i>No</i>	

Accessing User Tools (Copier/Document Server Features)

This section is for key operators in charge of this machine. You can change or set defaults.

Note

- r Be sure to quit User Tools and return to the initial copy display after all the settings are finished. This section describes system settings that you can set for the copier.
- r The selected key is highlighted.
- r Any changes you make with User Tools remain in effect even if the main power switch or operation switch is turned off, or the **[Clear Modes]** key is pressed.

Reference

For details, see "User Tools (System Settings)", *General Settings Guide*.

1 Press the **[User Tools/Counter]** key.

The User Tools main menu appears.



Note

- r When the access code is set, the access code input display appears when changing the initial settings. Operate by entering the registered access code beforehand. For access code, see "Key Operator Tools", *General Settings Guide*.

2 Press **[Copier/Document Server Features]**.

The Copier/Document Server Features menu appears.

3 Select the menu you want to set.

The setting display for each menu will appear.

Reference

p.83 "User Tools Menu (Copier/Document Server Features)"

4 Change settings by following the instructions on the display panel, and then press **[OK]**.

Quitting User Tools

1 After changing User Tools settings, press **[Exit]** on the User Tools main menu.

Changes to User Tools are complete, and the machine is ready to copy.



Note

- r You can also quit User Tools by pressing the **[User Tools/Counter]** key.

General Features 1/4

v Auto Paper Select Priority

As a default, Auto Paper Select is selected. You can cancel this setting. See p.23 "Selecting Copy Paper".

 **Note**

r Default: *Yes*

v Auto Tray Switching

If you load paper of the same size in two or more trays, the machine automatically shifts to the other tray when the first tray in use runs out of paper (when Auto Paper Select is selected.) This function is called "Auto Tray Switching". This setting specifies whether to use Auto Tray Switching or not.

 **Note**

r Default: *With image rotation*

r **[With image rotation]** Use this to copy with Auto Tray Switching.

r **[Without image rotation]** Only copies with Auto Tray Switching if you load paper of the same size and in the same direction in two or more trays. If the paper is not the same size or in the same orientation, copying is interrupted and "Load paper." appears.

r **[OFF]** When a paper tray runs out of paper, copying is interrupted and "Load paper." appears.

v Paper Display

You can choose to have the available paper trays and sizes shown on the initial display.

 **Note**

r Default: *Display*

r If you select **[Hide]**, the display is shown as below. Press **[Auto Paper Select]** to display paper sizes.

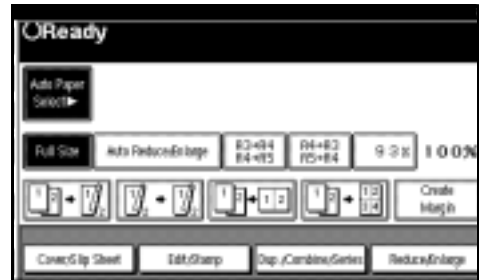

v Original Type Priority

You can select the type of originals to be effective when the power is turned on, reset or modes are cleared. See p.22 "Selecting Original Type Setting".

 **Note**

r Default: *Text*

v Original Type Display

You can choose to have the original types shown on the initial display.

 **Note**

r Default: *Display*

r If you select **[Hide]**, the display is shown as below.

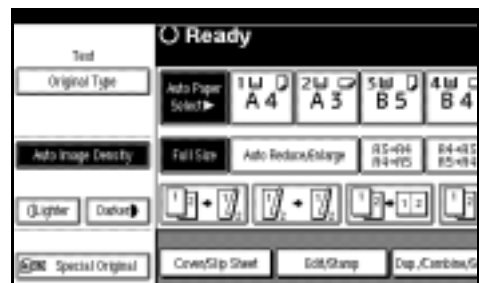

v Auto Image Density Priority

Set this function to use Auto Image Density when the power is turned on, reset or modes are cleared.

Note

r Default: *Text: On, Text/Photo: On, Photo: Off, Pale: On, Generation Copy: On*

v Copy Quality

You can adjust the quality level of copies for each of the original types (Text, Text/Photo, Photo, Pale, Generation Copy).

- Text
Adjust the sharpness of text.

Note

r Default: *Normal*
r **[Custom Setting]** is the value set during service setup.
r Choosing **[Sharp]** or **[Soft]** affects the outline sharpness of text.

- Text/Photo
When there are photo(s) and text on the original, determine whether the photo or text takes priority.

Note

r Default: *Normal*
r **[Custom Setting]** is the value set during service setup.
r **[Normal]** achieves a good balance between text and photos.

- Photo
For a photo original, adjust the finish quality level to match the type of photo original.

Note

r Default: *Print Photo*
r **[Custom Setting]** is the value set during service setup.
r Select **[Print Photo]** for printed photo originals, and **[Glossy Photo]** for printed photo originals with fine dots.
r Select **[Normal]** for printed photo and text originals.

- Pale
Adjust the quality level for the finish of a pale original with normal density.

Note

r Default: *Normal*
r **[Custom Setting]** is the value set during service setup.

- Generation Copy
Adjust the quality level so as not to thicken the lines of the finish image.

Note

r Default: *Normal*
r **[Custom Setting]** is the value set during service setup.

v Image Density

You can select one of seven original image density levels for each of the original types (Text, Text/Photo, Photo, Pale, Generation Copy).

Note

r Default: *Text: Normal, Text/Photo: Normal, Photo: Normal, Pale: Normal, Generation Copy: Normal*

General Features^{2/4}

v Duplex Mode Priority

You can select the type of Duplex function effective when the machine is turned on, reset, or modes are cleared.

Note

r Default: *Text: Normal, Text/Photo: Normal, Photo: Normal, Pale: Normal, Generation Copy: Normal*

v Copy Orientation in Duplex Mode

You can set the copy orientation when making two-sided copies.

Note

r Default: *Top to Top*

v Original Orientation in Duplex Mode

You can set the original orientation when making two-sided copies.

Note

r Default: *Top to Top*

v Change Initial Mode

You can select initial mode or Program No.10 as the mode effective when the machine is turned on, reset, or modes are cleared.

Note

r Default: *Standard*

v Max. Copy Quantity

The maximum copy quantity can be set between 1 and 999.

Note

r Default: *999 Sheets.*

v Tone: Original remains

The beeper (key tone) sounds if you forget to remove originals after copying.

Note

r Default: *On*

r If Panel Tone of User Tools (System Settings) is [**Off**], the beeper does not sound irrespective of the Tone: Original remains setting. See "Panel Tone" in "General Features", *General Settings Guide*.

v Job End Call

You can choose whether or not the beeper sounds when copying is complete.

Note

r Default: *On*

r If Panel Tone of User Tools (System Settings) settings is [**On**], the machine beeps to notify you that it did not complete a job for reasons such as copying was interrupted, the paper tray ran out of paper, or a paper jam occurred.

General Features ³/₄

✓ Copy Function Key: F1-F5

You can assign frequently used functions to function keys F1 to F5.

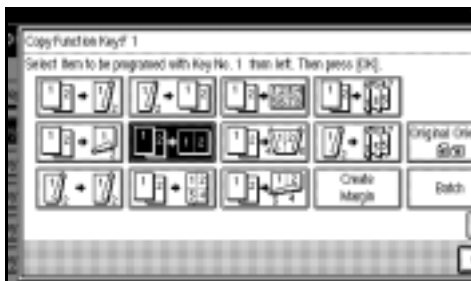

Note

r Default:

- Copy Function Key: F1: 1 Sided → 2 Sided: T to T
- Copy Function Key: F2: 2 Sided: T to T → 2 Sided: T to T
- Copy Function Key: F3: 1 Sided → 1 Sided Combine
- Copy Function Key: F4: 1 Sided → 1 Sided Combine: 4 originals
- Copy Function Key: F5: Create Margin

General Features ⁴/₄

✓ Document Server Storage Key: F1-F5

You can assign frequently used functions to function keys F1 to F5. You can also change the assigned functions.

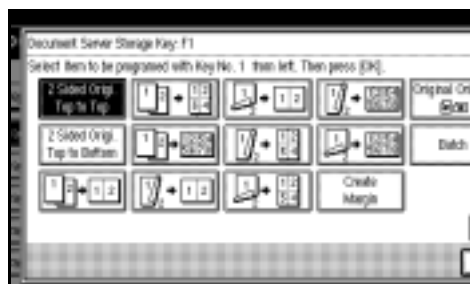

Note

r Default

- Document Server Storage Key: F1: 2 Sided Original Top to top
- Document Server Storage Key: F2: 1 Sided → 1 Sided Combine
- Document Server Storage Key: F3: 1 Sided → 1 Sided Combine: 4 originals
- Document Server Storage Key: F4: 1 Sided → 1 Sided Combine: 8 originals
- Document Server Storage Key: F5: Create Margin

Reproduction Ratio¹/₂

v Shortcut R/E

You can register up to three frequently used Reduce/Enlarge ratios other than the fixed Reduce/Enlarge ratio and have them shown on the initial display. You can also change registered Reduce/Enlarge ratios.

If no Reduce/Enlarge ratio has been set when selecting **[Shortcut R/E 1]**, **[Shortcut R/E 2]**, or **[Shortcut R/E 3]**, enter the desired Reduce/Enlarge ratio using the number keys.

v Enlarge 1-5

You can customize available enlargement ratios by pressing **[Reduce/Enlarge]** followed by **[Enlarge]**.

115% B4→A3	122% F→A3 A4→B4	141% A4→A3 A5→A4	200% A5→A3	400%
Enlarge1	Enlarge2	Enlarge3	Enlarge4	Enlarge5

Note

r Default:

- Metric version:
 - Enlarge 1: 115%
 - Enlarge 2: 122%
 - Enlarge 3: 141%
 - Enlarge 4: 200%
 - Enlarge 5: 400%
- Inch version:
 - Enlarge 1: 121%
 - Enlarge 2: 129%
 - Enlarge 3: 155%
 - Enlarge 4: 200%
 - Enlarge 5: 400%

r When selecting **[User Enlrg. Ratio]**, enter a ratio using the number keys (from 101 to 400%).

v Priority Setting: Enlarge

You can set the ratio with priority when **[Reduce/Enlarge]** is pressed, followed by **[Enlarge]**.

Note

r Default:

- Metric version: 141%
- Inch version: 155%

Reproduction Ratio²/₂

v Reduce 1-6

You can customize available reduction ratios by pressing **[Reduce/Enlarge]** followed by **[Reduce]**.

25%	50% A3→A5 F→A5	65% A3→F	71% A3→A4 A4→A5	75% B4→F4 B4→F	82% F→A4 B4→A4
Reduce1	Reduce2	Reduce3	Reduce4	Reduce5	Reduce6

Note

r Default:

- Metric version:
 - Reduce 1: 25%
 - Reduce 2: 50%
 - Reduce 3: 65%
 - Reduce 4: 71%
 - Reduce 5: 75%
 - Reduce 6: 82%
- Inch version:
 - Reduce 1: 25%
 - Reduce 2: 50%
 - Reduce 3: 65%
 - Reduce 4: 73%
 - Reduce 5: 78%
 - Reduce 6: 85%

r When selecting **[User Redc.Ratio]**, enter a ratio using the number keys (from 25 to 99%).

v **Priority Setting: Reduce**

You can set the ratio with priority when **[Reduce/Enlarge]** is pressed, followed by **[Reduce]**.

Note

r Default:

- Metric version: 71%
- Inch version: 73%

v **Ratio for Create Margin**

You can set a Reduce/Enlarge ratio when registering Create Margin in a shortcut key.

Note

r Default: 93%

v **R/E Priority**

Specifies which tab is given priority on the display panel when **[Reduce/Enlarge]** is pressed.

Note

r Default: *Reduce*

Edit 1/2

Note

r Enter the width of the binding margin with the number keys as follows:

- Metric version: 0–30 mm (in increments of 1 mm)
- Inch version: 0"–1.2" (in increments of 0.1 inch)

r Enter the width of the erased margin with the number keys as follows:

- Metric version: 2–99 mm (in increments of 1 mm)
- Inch version: 0.1"–3.9" (in increments of 0.1 inch)

v **Front Margin: Left/Right**

You can specify left and right margins on the front side of copies in Margin Adjustment mode.

Note

r Default:

- Metric version: *Left 5 mm*
- Inch version: *Left 0.2"*

v **Back Margin: Left/Right**

You can specify left and right margins on the back side of copies in Margin Adjustment mode.

Note

r Default:

- Metric version: *Right 5 mm*
- Inch version: *Right 0.2"*

v **Front Margin: Top/Bottom**

You can specify top and bottom margins on the front side of copies in Margin Adjustment mode.

Note

r Default:

- Metric version: *Top/Bottom 0 mm*
- Inch version: *Top/Bottom 0.0"*

v **Back Margin: Top/Bottom**

You can specify top and bottom margins on the back side of copies in Margin Adjustment mode.

Note

r Default:

- Metric version: *Top/Bottom 0 mm*
- Inch version: *Top/Bottom 0.0"*

- v **1 Sided→2 Sided Auto Margin: TtoT**
In 1 sided → 2 sided Duplex mode, you can specify the margins on the back side.
The margin is set to the same value of "Back Margin: Left/Right".

Note

- r Default:
 - Metric version: *Right 5 mm*
 - Inch version: *Right 0.2"*

- v **1 Sided→2 Sided Auto Margin: TtoB**
In 1 sided → 2 sided Duplex mode, you can specify the margins on the back side. The value set for "Back Margin: Top/Bottom" is used.

Note

- r Default:
 - Metric version: *Top/Bottom 0 mm*
 - Inch version: *Top/Bottom 0.0"*

- v **Erase Border Width**
You can specify the width of the erased border margins with this function.

Note

- r Default:
 - Metric version: *10 mm*
 - Inch version: *0.4"*

- v **Erase Original Shadow in Combine**
In Combine mode, you can specify whether to erase a 3 mm, 0.1" boundary margin around all four edges of each original.

Note

- r Default: *Yes*

- v **Erase Centre Width**
You can specify the width of the erased centre margins with this function.

Note

- r Default:
 - Metric version: *10 mm*
 - Inch version: *0.4"*

Edit²/₂

Note

- r The image area of approximately 1.5 mm (0.06") wide on the separation line may not be copied, when specifying solid or broken lines.

- v **Image Repeat Separation Line**
You can select a separation line in Image Repeat mode from None, Solid, Broken A, Broken B, or Crop Marks.

- None



- Solid



- Broken A



- Broken B



- Crop Marks



Note

- r Default: *None*

v **Double Copies Separation Line**

You can select a separation line in Double Copies mode from None, Solid, Broken A, Broken B, or Crop Marks.

- None



- Solid



- Broken A



- Broken B



- Crop Marks



Note

r Default: *None*

v **Separation Line in Combine**

You can select a separation line in Combine mode from None, Solid, Broken A, Broken B, or Crop Marks. See p.45 “One-Sided Combine” and p.47 “Two-Sided Combine”.

- None



- Solid



- Broken A



- Broken B



- Crop Marks



Note

r Default: *None*

v **Copy on Designating Paper**

You can specify whether to copy on the designating paper.

Note

r Default: *Yes*

v **Front Cover Copy in Combine**

You can make a combined copy on the front cover sheet when you select Front Cover mode.

Combine				Not Combined				
1	2	5	6	1	2	3	6	7
3	4	7	8		4	5	8	

Note

r Default: *Combine*

v **Copy on Designating Page in Combine**

You can specify whether to make a combined copy on the inserted slip sheets in Desig./Chapter mode.

Note

r Default: *Combine*

v **Orientation: Booklet, Magazine**

You can select the orientation of copies to open when using Booklet or Magazine mode.

 **Note**

r Default: *Open to Left*

 **Reference**

p.51 "How to fold and unfold copies to make a booklet"

p.51 "How to fold and unfold copies to make a magazine"

v **Copy Order in Combine**

You can set the copy order in Combine mode to Left to Right or Top to Bottom.

From Left to Right	From Top to Bottom																
<table border="1"> <tr><td>1</td><td>2</td></tr> <tr><td>3</td><td>4</td></tr> </table>	1	2	3	4	<table border="1"> <tr><td>1</td><td>3</td></tr> <tr><td>2</td><td>4</td></tr> </table>	1	3	2	4								
1	2																
3	4																
1	3																
2	4																
<table border="1"> <tr><td>1</td><td>2</td><td>3</td><td>4</td></tr> <tr><td>5</td><td>6</td><td>7</td><td>8</td></tr> </table>	1	2	3	4	5	6	7	8	<table border="1"> <tr><td>1</td><td>3</td><td>5</td><td>7</td></tr> <tr><td>2</td><td>4</td><td>6</td><td>8</td></tr> </table>	1	3	5	7	2	4	6	8
1	2	3	4														
5	6	7	8														
1	3	5	7														
2	4	6	8														

 **Note**

r Default: *From left to right*

Stamp

Background Numbering

v **Size**

You can set the size of the numbers.

 **Note**

r Default: *Normal*

v **Density**

You can set the density of the numbers.

 **Note**

r Default: *Normal*

Preset Stamp^{1/4-4/4}

v **Stamp Priority**

You can select the stamp type given priority when **[Preset Stamp]** is pressed. See p.59 "Preset Stamp".

 **Note**

r Default: *Copy*

v **Stamp Language**

You can select the language of the message printed in Stamp mode.

 **Note**

r Default: *English*

v **Stamp Position**

You can set the position at which the stamp is printed.

Press the arrow keys to adjust the position.

 **Note**

r Default:

- Metric Version:
 - Position: *Top right*
 - Top Margin: *24 mm*
 - Right Margin: *24 mm*
- Inch Version:
 - Position: *Top right*
 - Top Margin: *1.0"*
 - Right Margin: *1.0"*

v Stamp Format

You can adjust the size, density, and print page for the stamp.

- Size
You can set the size of the stamp.

Note

r Default: *1X*

- Density
You can set the pattern used to print the stamp.

Note

r Default: *Normal*

r Normal: The stamp is printed on the image. You cannot check which parts will overlap.

r Lighter : The image can be seen through the stamp.

r Lightest : You can see the image even clearer than in the Lighter setting.

- Page to Stamp
You can have the stamp printed on the first page or all pages.

Note

r Default: *All Pages*

User Stamp^{1/2-2/2}

v Program/Delete Stamp

You can register, change, or delete these designs as user stamps.

Note

r You can register up to four custom stamps with your favorite designs. See p.61 "To program the user stamp".

Reference

For how to delete the user stamp, see p.62 "To delete the user stamp".

v Stamp Position 1 - 4

You can set the position at which the stamp is printed.

Press the arrow keys to adjust the position.

Note

r Default:

- Metric version:
 - Position: *Top right*
 - Top Margin: *24 mm*
 - Right Margin: *24 mm*
- Inch version:
 - Position: *Top right*
 - Top Margin: *1.0"*
 - Right Margin: *1.0"*

v Stamp Format 1 - 4

You can adjust the print page for User Stamps 1 to 4 already registered.

- Page to Stamp
Sets whether to print the stamp on all pages or only on the first page.

Note

r Default: *All Pages*

Date Stamp

v Format

You can select the date format for Date Stamp mode.

Note

r Default:

- Metric version: *DD/MM/YYYY*
- Inch version: *MM/DD/YYYY*

v Font

You can select the Date Stamp font.

Note

- r Default: *Font 1*
- r This setting is linked with Page Numbering.

v Stamp Position

You can set the position at which the stamp is printed. Press the arrow keys to adjust the position.

Note

- r Default:
 - Metric version:
 - Position: *Top left*
 - Top Margin: *8 mm*
 - Left Margin: *32 mm*
 - Inch version:
 - Position: *Top left*
 - Top Margin: *0.3"*
 - Left Margin: *0.8"*

v Stamp Setting

You can have the date printed on the first page or all pages.

Note

- r Default: *All Pages*

v Size

You can set the Date Stamp size.

Note

- r Default: *Auto*

v Superimpose

You can have the Date Stamp printed in white when it overlaps black parts of the image.

Note

- r Default: *No*

Page Numbering $1/2-2/2$

v Stamp Format

You can select the page number format given priority when [Page Numbering] is pressed.

Note

- r Default: *P1, P2*

v Font

You can select the page number printed in Page Numbering mode.

Note

- r Default: *Font 1*

v Size

You can set the size of the stamp printed in Page Numbering mode.

Note

- r Default: *Auto*

v Duplex Back Page Stamping Position

You can set the position of the duplex back page number printed in Duplex mode.

Note

- r Default: *Opposite Position*

v Page Numbering in Combine

You can set page numbering when using the Combine function and the Page Numbering function together.

Note

- r Default: *Per original*

v Stamp on Designating Slip Sheet

You can select to print the page number onto slip sheets when using the Designate function set to [Copy] and the Page Numbering function together.

Note

- r Default: *No*

v **Stamp Position**

P1, P2... Stamp Position: 1/5, 2/5...
Stamp Position: -1-, -2-... Stamp
Position: P.1, P.2... Stamp Position:
1, 2... Stamp Position: 1-1, 1-2...

You can set the position at which
the stamp is printed.
Press the arrow keys to adjust the
position.

v **Superimpose**

You can have page numbers print-
ed in white when they overlap
black parts of the image.

Note

r Default: *No*

Input/Output

v **Switch to Batch (SADF)**

You can select to have Batch mode
or SADF mode displayed when
you press the **[Special Original]** key.
See p.12 “Batch mode”.

Note

r Default: *Batch*

v **SADF Auto Reset**

When you place one original at a
time in the ADF, the **Auto Feed** in-
dicator lights for a specified time
after an original is fed to show that
the ADF is ready for another origi-
nal. You can adjust this time from
3 to 99 seconds in increments of 1
second .

Note

r Default: *5 seconds*

v **Rotate Sort: Auto Paper Continue**

You can specify to continue copy-
ing when paper of the required ori-
entation has run out during rotate-
sorting. See p.31 “Rotate Sort”.

Note

r If you select **[No]** :

- When paper of the required
orientation runs out, the ma-
chine stops copying and
prompts you to supply copy
paper. After you have loaded
paper, the machine will con-
tinue copying.

r If you select **[Yes]** :

- Copying continues using
copy paper of a different ori-
entation. The copy job will
finish even if you have left
the machine.

r Default: *No*

v **Auto Sort**

You can specify whether Sort
mode is selected when the ma-
chine is turned on or the mode is
cleared.

Note

r Default: *No*

v **Memory Full Auto Scan Restart**

When memory becomes full while
scanning originals, the machine
can make copies of scanned origi-
nals first, and then automatically
proceed scanning remaining origi-
nals.

You can enable or disable this
function.

 **Note**

- r If you select **[No]** :
 - When memory becomes full, the machine stops operation allowing you to remove the copy pages delivered on the output tray.
- r If you select **[Yes]** :
 - You can leave the machine unattended to make copies, but sorted pages will not be sequential.
- r Default: *No*

v **Select Stack Function**

Specify whether Stack or Rotate Sort has priority to be shown on the initial display.

 **Note**

- r Default: *Stack*
- r An optional finisher is required to use this function.

v **Select Stapling Position**

Specify which Top 2 staples or Bottom shown on the initial display with priority.

 **Note**

- r Default: *Top 2*
- r The optional 2 Tray finisher or booklet finisher is required to use this function.

v **Select Punch Type**

Specify which punch type (2 holes or 3 holes) has priority to be shown on the initial display.

 **Note**

- r Default: *2 holes*
- r The optional 2 Tray finisher equipped with the punch function is required.

v **Letterhead Setting**

If you select **[Yes]** in this function, the machine rotates the image correctly.

 **Note**

- r Default: *No*
- r Orientation-fixed (top to bottom) or two-sided paper might not be printed correctly depending on how the originals and paper are placed.

 **Reference**

When using letterhead paper, be careful of the paper orientation. See “Orientation-Fixed Paper or Two-Sided Paper” in “Loading Paper”, *General Settings Guide*.

5. Specifications

Combination Chart

The combination chart given below shows which modes can be used together. When you read the chart, see the following table:

m	These modes can be used together.
●	These modes cannot be used together. The second mode selected will be the mode you are working in.
×	These modes cannot be used together. The first mode selected will be the mode you are working in.

The following shows the combinations of functions.

		Function selected after																																					
		Mixed Sizes	Custom Size Originals	Original Orientation(Standard Orientation)	Auto Image Density	Manual Image Density	Auto Paper Select	Manual Paper Select	Copying from the Bypass Tray	Auto Reduce/Enlarge	Reduce/Enlarge	Create Margin Mode	Book	1 Sided → 2 Sided / 2 Sided → 2 Sided / 2 Sided → 1 Sided	Combine	Book → 2 Sided / Front & Back → 2 Sided	Booklet	Magazine	Double Copies	Image Repeat	Margin Adjustment	Positive/Negative	Centering	Center Erase	Border Erase	Background Numbering	Preset Stamp	Page Numbering	Cover / Designate	Slip Sheet	Sort	Stack	Staple	Punch	Store File				
Function selected first	Mixed Sizes	×	○	○	○	○	○	○	○	○	○	○	○	○	○	○	○	○	○	○	○	○	○	○	○	○	○	○	○	○	○	○	○	○	○	○	○		
	Custom Size Originals	×	○	○	○	○	○	○	○	○	○	○	○	○	○	○	○	○	○	○	○	○	○	○	○	○	○	○	○	○	○	○	○	○	○	○	○		
	Original Orientation(Standard Orientation)	○	×	○	○	○	○	○	○	○	○	○	○	○	○	○	○	○	○	○	○	○	○	○	○	○	○	○	○	○	○	○	○	○	○	○	○	○	
	Auto Image Density	○	○	×	○	○	○	○	○	○	○	○	○	○	○	○	○	○	○	○	○	○	○	○	○	○	○	○	○	○	○	○	○	○	○	○	○	○	
	Manual Image Density	○	○	○	×	○	○	○	○	○	○	○	○	○	○	○	○	○	○	○	○	○	○	○	○	○	○	○	○	○	○	○	○	○	○	○	○	○	
	Auto Paper Select	○	○	○	○	×	○	○	○	○	○	○	○	○	○	○	○	○	○	○	○	○	○	○	○	○	○	○	○	○	○	○	○	○	○	○	○	○	
	Manual Paper Select	○	○	○	○	○	×	○	○	○	○	○	○	○	○	○	○	○	○	○	○	○	○	○	○	○	○	○	○	○	○	○	○	○	○	○	○	○	
	Copying from the Bypass Tray	○	○	○	○	○	○	×	○	○	○	○	○	○	○	○	○	○	○	○	○	○	○	○	○	○	○	○	○	○	○	○	○	○	○	○	○	○	
	Auto Reduce/Enlarge	○	○	○	○	○	○	○	×	○	○	○	○	○	○	○	○	○	○	○	○	○	○	○	○	○	○	○	○	○	○	○	○	○	○	○	○	○	○
	Reduce/Enlarge	○	○	○	○	○	○	○	○	×	○	○	○	○	○	○	○	○	○	○	○	○	○	○	○	○	○	○	○	○	○	○	○	○	○	○	○	○	○
	Create Margin Mode	○	○	○	○	○	○	○	○	○	×	○	○	○	○	○	○	○	○	○	○	○	○	○	○	○	○	○	○	○	○	○	○	○	○	○	○	○	○
	Book	○	○	○	○	○	○	○	○	○	○	×	○	○	○	○	○	○	○	○	○	○	○	○	○	○	○	○	○	○	○	○	○	○	○	○	○	○	○
	1 Sided → 2 Sided / 2 Sided → 2 Sided / 2 Sided → 1 Sided	○	○	○	○	○	○	○	○	○	○	○	×	○	○	○	○	○	○	○	○	○	○	○	○	○	○	○	○	○	○	○	○	○	○	○	○	○	○
	Combine	○	○	○	○	○	○	○	○	○	○	○	○	×	○	○	○	○	○	○	○	○	○	○	○	○	○	○	○	○	○	○	○	○	○	○	○	○	○
	Book → 2 Sided / Front & Back → 2 Sided	○	○	○	○	○	○	○	○	○	○	○	○	○	×	○	○	○	○	○	○	○	○	○	○	○	○	○	○	○	○	○	○	○	○	○	○	○	○
	Booklet	○	○	○	○	○	○	○	○	○	○	○	○	○	○	×	○	○	○	○	○	○	○	○	○	○	○	○	○	○	○	○	○	○	○	○	○	○	○
	Magazine	○	○	○	○	○	○	○	○	○	○	○	○	○	○	○	×	○	○	○	○	○	○	○	○	○	○	○	○	○	○	○	○	○	○	○	○	○	○
	Double Copies	○	○	○	○	○	○	○	○	○	○	○	○	○	○	○	○	×	○	○	○	○	○	○	○	○	○	○	○	○	○	○	○	○	○	○	○	○	○
	Image Repeat	○	○	○	○	○	○	○	○	○	○	○	○	○	○	○	○	○	×	○	○	○	○	○	○	○	○	○	○	○	○	○	○	○	○	○	○	○	○
	Margin Adjustment	○	○	○	○	○	○	○	○	○	○	○	○	○	○	○	○	○	○	×	○	○	○	○	○	○	○	○	○	○	○	○	○	○	○	○	○	○	○
	Positive/Negative	○	○	○	○	○	○	○	○	○	○	○	○	○	○	○	○	○	○	○	○	×	○	○	○	○	○	○	○	○	○	○	○	○	○	○	○	○	○
	Centering	○	○	○	○	○	○	○	○	○	○	○	○	○	○	○	○	○	○	○	○	○	×	○	○	○	○	○	○	○	○	○	○	○	○	○	○	○	○
	Center Erase	○	○	○	○	○	○	○	○	○	○	○	○	○	○	○	○	○	○	○	○	○	○	×	○	○	○	○	○	○	○	○	○	○	○	○	○	○	○
	Border Erase	○	○	○	○	○	○	○	○	○	○	○	○	○	○	○	○	○	○	○	○	○	○	○	×	○	○	○	○	○	○	○	○	○	○	○	○	○	○
	Background Numbering	○	○	○	○	○	○	○	○	○	○	○	○	○	○	○	○	○	○	○	○	○	○	○	○	×	○	○	○	○	○	○	○	○	○	○	○	○	○
	Preset Stamp	○	○	○	○	○	○	○	○	○	○	○	○	○	○	○	○	○	○	○	○	○	○	○	○	○	×	○	○	○	○	○	○	○	○	○	○	○	○
	Page Numbering	○	○	○	○	○	○	○	○	○	○	○	○	○	○	○	○	○	○	○	○	○	○	○	○	○	○	○	×	○	○	○	○	○	○	○	○	○	○
	Cover / Designate	○	○	○	○	○	○	○	○	○	○	○	○	○	○	○	○	○	○	○	○	○	○	○	○	○	○	○	○	○	×	○	○	○	○	○	○	○	
	Slip Sheet	○	○	○	○	○	○	○	○	○	○	○	○	○	○	○	○	○	○	○	○	○	○	○	○	○	○	○	○	○	○	○	○	○	○	○	○	○	
	Sort	○	○	○	○	○	○	○	○	○	○	○	○	○	○	○	○	○	○	○	○	○	○	○	○	○	○	○	○	○	○	○	○	○	○	○	○	○	
	Stack	○	○	○	○	○	○	○	○	○	○	○	○	○	○	○	○	○	○	○	○	○	○	○	○	○	○	○	○	○	○	○	○	○	○	○	○	○	
	Staple	○	○	○	○	○	○	○	○	○	○	○	○	○	○	○	○	○	○	○	○	○	○	○	○	○	○	○	○	○	○	○	○	○	○	○	○	○	
	Punch	○	○	○	○	○	○	○	○	○	○	○	○	○	○	○	○	○	○	○	○	○	○	○	○	○	○	○	○	○	○	○	○	○	○	○	○	○	
Store File	○	○	○	○	○	○	○	○	○	○	○	○	○	○	○	○	○	○	○	○	○	○	○	○	○	○	○	○	○	○	○	○	○	○	○	○	○		

*1 You cannot combine if you select 2 sided to copy.

*2 You cannot combine with Rotate Sort.

*3 You cannot combine Cover with 2 Sided → 1 Sided.

*4 You cannot combine Designate with Magazine.

*5 You cannot combine Staple Top 2 with Standard Punch position.

You cannot combine Staple Top , Top Slant, and Bottom with 90° turn Punch position.

*6 Available with the optional 2 Tray Finisher.

Supplementary Information

v **Mixed Size mode**

- Since small originals may not be correctly aligned with the original guide, the copy image may be slanted.
- Copying speed and scanning speed will be reduced.
- You can place originals of two different sizes at a time.

v **Bypass Tray Copy**

- The following paper sizes can be selected as the standard sizes:
 A3, A4, A5, A6, B4 JIS, B5 JIS, B6 JIS, Postcard, 11"×17", 8¹/₂"×14", 8¹/₂"×11", 5¹/₂"×8¹/₂", 7¹/₄"×10¹/₂", 8"×13", 8¹/₂"×13", 8¹/₄"×13", 11"×14", 11"×15", 10"×14", 10"×15", 8¹/₄"×14", 8"×10¹/₂", 8"×10"
- When the beeper is turned off, it will not sound if you insert paper into the bypass tray. See *General Settings Guide*.

5

v **Preset Enlarge/Reduce**

- You can select one of 12 preset ratios (5 enlargement ratios, 7 reduction ratios).
- You can select a ratio regardless of the size of an original or copy paper. With some ratios, parts of the image might not be copied or margins will appear on copies.
- Copies can be reduced or enlarged as follows:

v **Metric version**

Ratio (%)	Original → Copy paper size
400 (enlarge area by 16)	--
200 (enlarge area by 4)	A5→A3
141 (enlarge area by 2)	A4→A3, A5→A4
122	F→A3, A4→B4 JIS
115	B4 JIS→A3
93	--
82	F→A4, B4 JIS→A4
75	B4 JIS→F4, B4 JIS→F
71 (reduce area by 1/2)	A3→A4, A4→A5
65	A3→F
50 (reduce area by 1/4)	A3→A5, F→A5
25	--

v Inch version

Ratio (%)	Original → Copy paper size
400 (enlarge area by 16)	--
200 (enlarge area by 4)	$5\frac{1}{2}'' \times 8\frac{1}{2}'' \rightarrow 11'' \times 17''$
155 (enlarge area by 2)	$5\frac{1}{2}'' \times 8\frac{1}{2}'' \rightarrow 8\frac{1}{2}'' \times 14''$
129	$8\frac{1}{2}'' \times 11'' \rightarrow 11'' \times 17''$
121	$8\frac{1}{2}'' \times 14'' \rightarrow 11'' \times 17''$
93	--
85	F → $8\frac{1}{2}'' \times 11''$
78	$8\frac{1}{2}'' \times 14'' \rightarrow 8\frac{1}{2}'' \times 11''$
73	$11'' \times 15'' \rightarrow 8\frac{1}{2}'' \times 11''$
65	$11'' \times 17'' \rightarrow 8\frac{1}{2}'' \times 11''$
50 (reduce area by $\frac{1}{4}$)	$11'' \times 17'' \rightarrow 5\frac{1}{2}'' \times 8\frac{1}{2}''$
25	--

v Zoom

- The reproduction ratios you can specify are 25–400%.
- You can select a ratio regardless of the size of an original or copy paper. With some ratios, parts of the image might not be copied or margins will appear on copies.

v Size Magnification

- If the calculated ratio is over the maximum or under the minimum ratio, it is automatically adjusted to within available range. However, with some ratios, parts of the image might not be copied or margins will appear on copies.
- The reproduction ratios you can specify are 25–400%.

v Directional Size Magnification

- The reproduction ratio you can specify are 25–400%.
- When entering a percentage ratio, you can specify any value in the permitted range, regardless of original or copy paper size. However, depending on settings and other conditions, part of the image may not be copied, or margins will appear on copies.
- When entering a size in mm, if the calculated ratio is over the maximum or under the minimum ratio, it is automatically adjusted to within available range. However, with some ratios, parts of the image might not be copied or margins will appear on copies.

▼ **Sort, Rotate Sort, Stack**

















































- Paper sizes and orientations that can be used in the Shift Sort and Stack functions are as follows:

	1000-Sheet finisher	2 Tray finisher	Booklet finisher
Paper size and orientation	A3, B4 JIS, A4, B5 JIS, A5, 5 ¹ / ₂ " × 8 ¹ / ₂ ", 11" × 17", 8 ¹ / ₂ " × 14", 8 ¹ / ₄ " × 13", 8" × 13", 8 ¹ / ₂ " × 11", 7 ¹ / ₄ " × 10 ¹ / ₂ "	A3, B4 JIS, A4, B5 JIS, A5, 11" × 17", 8 ¹ / ₂ " × 14", 8 ¹ / ₂ " × 11", 5 ¹ / ₂ " × 8 ¹ / ₂ "	A3, B4 JIS, A4, B5 JIS, 11" × 17", 8 ¹ / ₂ " × 14", 8 ¹ / ₂ " × 11"

- Paper sizes and orientations that can be used in the Rotate Sort function are A4, B5 JIS and 8¹/₂" × 11".
- The number of copies that can be placed on the tray is as follows. When the number of copies exceeds capacity, remove copies from the tray.

5

	Paper size and orientation	Paper capacity and weight
Internal tray	<ul style="list-style-type: none"> • A4 or smaller • 8¹/₂" × 11" or smaller 	500 sheets ^{*1} (80 g/m ²) (20 lb.)
	<ul style="list-style-type: none"> • B4 JIS or larger • 8¹/₂" × 14" or larger 	250 sheets ^{*2} (80 g/m ²) (20 lb.)
Internal tray 2 (1 bin tray)	A3, B4 JIS, A4, B5 JIS, A5, B6 JIS, A6, 11" × 17", 8 ¹ / ₂ " × 14", 8 ¹ / ₂ " × 11", 7 ¹ / ₄ " × 10 ¹ / ₂ ", 5 ¹ / ₂ " × 8 ¹ / ₂ ", 8" × 13", 8 ¹ / ₂ " × 13", 8 ¹ / ₄ " × 13"	125 sheets (80 g/m ²) (20 lb.)
1000-Sheet finisher	Finisher upper tray	
	<ul style="list-style-type: none"> • A4 or smaller • 8¹/₂" × 11" or smaller 	250 sheets (80 g/m ²) (20 lb.)
	<ul style="list-style-type: none"> • B4 JIS or larger • 8¹/₂" × 14" or larger 	50 sheets (80 g/m ²) (20 lb.)
	Finisher shift tray	
	<ul style="list-style-type: none"> • A4 or smaller • 8¹/₂" × 11" or smaller 	1000 sheets (80 g/m ²) (20 lb.)
	<ul style="list-style-type: none"> • B4 JIS or larger • 8¹/₂" × 14" or larger 	500 sheets (80 g/m ²) (20 lb.)

	Paper size and orientation	Paper capacity and weight
2 Tray finisher	Finisher shift tray 1	
	A4  , 8 1/2" x 11"  , A5  , B5 JIS 	500 sheets (80 g/m ²) (20 lb.)
	A3  , B4 JIS  , 11" x 17"  , 8 1/2" x 14" 	250 sheets (80 g/m ²) (20 lb.)
	A5  , 5 1/2" x 8 1/2" 	100 sheets (80 g/m ²) (20 lb.)
	Finisher shift tray 2	
	A4  , 8 1/2" x 11" 	2000 sheets ^{*3} (80 g/m ²) (20 lb.)
	A3  , B4 JIS  , A4  , B5 JIS  , A5  , 11" x 17"  , 8 1/2" x 14"  , 8 1/2" x 11" 	750 sheets (80 g/m ²) (20 lb.)
	A5 	500 sheets (80 g/m ²) (20 lb.)
A5  , 5 1/2" x 8 1/2" 	100 sheets (80 g/m ²) (20 lb.)	
Booklet finisher	Finisher upper tray	
	A3  , B4 JIS  , A4  , B5 JIS  , A5  , B6 JIS  , A6  , 11" x 17"  , 11" x 15"  , 8 1/2" x 14"  , 8 1/2" x 11"  , 5 1/2" x 8 1/2" 	150 sheets (80 g/m ²) (20 lb.)
	Finisher shift tray	
	A4  , B5 JIS  , A5  , 8 1/2" x 11" 	1000 sheets (80 g/m ²) (20 lb.)
	A3  , B4 JIS  , A4  , 11" x 17"  , 8 1/2" x 11" 	500 sheets (80 g/m ²) (20 lb.)
	Finisher booklet tray	
A3  , B4 JIS  , A4  , 11" x 17"  , 8 1/2" x 11" 	(80 g/m ²) (20 lb.) <ul style="list-style-type: none"> • 2–5 sheets: 25 sets • 6–10 sheets: 15 sets • 11–15 sheets: 10 sets 	

*1 250 sheets when the optional bridge unit is installed.



















*2 125 sheets when the optional bridge unit is installed.

*3 1,500 sheets when stapled.







































 **Note**

- r When using the Rotate Sort or Staple functions, the capacity may be reduced.

v Staple











- The following type of paper cannot be stapled:
 - Translucent paper
 - OHP transparencies
 - Label paper (adhesive labels)
 - Thick paper
 - Curled paper
 - Paper of low stiffness
 - Paper of mixed sizes
- In the following cases, copies will be delivered to the shift tray without stapling:
 - When the number of sheets for one set is over stapler capacity.
 - When memory reaches 0% during copying.
- When using Double Copies, or [1 Sided→1 Sided], [1 Sided→2 Sided], [2 Sided→1 Sided], or [2 Sided→2 Sided] in Combine mode, select  paper for  original and  paper for  original.
- When using Double Copies, or [1 Sided 2 Pages→ 1 Sided Combine] and [1 Sided 4 Pages→ 2 Sided Combine] in Combine mode, select  paper for  original and  paper for  original.
- When using [Left 2] or [Top 2] with Double Copies, or [1 Sided→1 Sided], [1 Sided→2 Sided], [2 Sided→1 Sided], or [2 Sided→2 Sided] in Combine mode, select  paper for  original and  paper for  original.
- When the booklet finisher is installed, even if you place different size originals in the ADF, appropriate size of copy paper can be automatically selected and stapled using the Mixed Size mode and Auto Paper Select function. Load the paper you want to use in the paper trays beforehand. Paper sizes that can be stapled when using the Mixed Size mode are as follows:
 - A3 and A4
 - B4 JIS and B5 JIS
 - 11" × 17" and 8¹/₂" × 11"



































- Paper sizes and orientation that can be used in the Staple function and the stapler capacity are as follows:

	Paper size	Stapler capacity
1000-Sheet finisher	A4  , B5 JIS  , 8 ¹ / ₂ " × 11"  , 7 ¹ / ₄ " × 10 ¹ / ₂ " 	50 sheets (80 g/m ²) (20 lb.)
	A3  , B4 JIS  , 12" × 18"  , 11" × 17"  , 8 ¹ / ₂ " × 14"  , 8 ¹ / ₂ " × 13"  , 8 ¹ / ₄ " × 13"  , 8" × 13"	30 sheets) (80 g/m ²) (20 lb.)
2 Tray finisher	A4  , B5 JIS  , 8 ¹ / ₂ " × 11"  , 7 ¹ / ₄ " × 10 ¹ / ₂ " 	50 sheets (80 g/m ²) (20 lb.)
	A3  , B4 JIS  , 11" × 17"  , 8 ¹ / ₂ " × 14"  , 8 ¹ / ₂ " × 13"  , 8 ¹ / ₄ " × 13"  , 8" × 13" 	30 sheets (80 g/m ²) (20 lb.)
Booklet finisher	A4  , B5 JIS  , 8 ¹ / ₂ " × 11"  , 7 ¹ / ₄ " × 10 ¹ / ₂ " 	50 sheets (80 g/m ²) (20 lb.)
	A3  , B4 JIS  , A4  , 11" × 17"  , 8 ¹ / ₂ " × 14"  , 8 ¹ / ₂ " × 13"  , 8 ¹ / ₂ " × 11" 	30 sheets (80 g/m ²) (20 lb.)
	When Saddle Stitch function is selected: A3  , B4 JIS  , A4  , 11" × 17"  , 8 ¹ / ₂ " × 11" 	15 sheets (80 g/m ²) (20 lb.)

 **Note**

- When the number of copies exceeds tray capacity, copying stops. If this happens, remove the copies from the shift tray, and then resume copying.
- The tray capacity for the stapled sheets is as follows: (paper weight: 80 g/m², 20 lb.)

	Paper size and orientation	Tray capacity
1000-Sheet finisher	A4  , 8 ¹ / ₂ " × 11" 	<ul style="list-style-type: none"> 10–50 sheets: 100–20 sets 2–9 sheets: 100 sets
	A4  , B5 JIS  , 8 ¹ / ₂ " × 11" 	<ul style="list-style-type: none"> 10–50 sheets: 50–10 sets 2–9 sheets: 100 sets
	A3  , B4 JIS  , 11" × 17"  , 8 ¹ / ₂ " × 14"  , 12" × 18" 	<ul style="list-style-type: none"> 10–30 sheets: 50–10 sets 2–9 sheets: 50 sets

	Paper size and orientation	Tray capacity
2 Tray finisher	Finisher shift tray 1	
	A4  , B5 JIS  , 8 1/2" x 11" 	<ul style="list-style-type: none"> • 10–50 sheets: 50–10 sets • 2–9 sheets: 50 sets
	A3  , B4 JIS  , 11" x 17"  , 8 1/2" x 14"  , 12" x 18" 	<ul style="list-style-type: none"> • 10–30 sheets: 25–8 sets • 2–9 sheets: 25 sets
	mixed size	<ul style="list-style-type: none"> • 2–30 sheets: 8 sets
	Finisher shift tray 2	
	A4  , 8 1/2" x 11" 	<ul style="list-style-type: none"> • 15–50 sheets: 100–30 sets • 2–14 sheets: 100 sets
	A4  , B5 JIS  , 8 1/2" x 11"  , 12" x 18" 	<ul style="list-style-type: none"> • 15–50 sheets: 50–15 sets • 2–14 sheets: 50 sets
	A3  , B4 JIS  , 11" x 17"  , 8 1/2" x 14"  , 12" x 18" 	<ul style="list-style-type: none"> • 15–30 sheets: 50–25 sets • 2–14 sheets: 50 sets
	mixed size	<ul style="list-style-type: none"> • 2–30 sheets: 25 sets
Booklet finisher	Finisher tray	
	A4  , B5 JIS  , A5  , 8 1/2" x 11" 	750 sheets or 30 sets
	A3  , B4 JIS  , A4  , 11" x 17"  , 8 1/2" x 14"  , 8 1/2" x 11" 	500 sheets or 30 sets
	Finisher booklet tray	
	A3  , B4 JIS  , A4  , 11" x 17"  , 8 1/2" x 11" 	<ul style="list-style-type: none"> • 2–5 sheets: 25 sets • 6–10 sheets: 15 sets • 11–15 sheets: 10 sets

- You cannot change stapling positions during copying.
- When the original image is rotated, the staple orientation changes by 90°.
- The maximum original image size that can be rotated is as follows:











Metric version	A4
Inch version	8 1/2" x 11"

- When using **[Top Slant]**, **[Left 2]** or **[Top 2]** with Combine, Double copies or Auto Reduce/Enlarge function, “Blank part will appear. Check orientation.” message may appear depending on the orientation of originals and paper you placed. In this case, change the paper orientation.
- When **[Left 2]** or **[Top 2]** is selected, the following settings are useful to rotate images appropriately:
 - Auto Reduce/Enlarge or Auto Paper Select
 - With image rotation in Auto Tray Switching of User Tools

- If you select Saddle Stitch function with the optional booklet finisher, the machine staples and folds the paper in the centre, then delivers the paper folded.
- If you select Saddle Stitch function in Magazine mode, the machine staples the paper, and folds it like a book, then delivers the paper folded.





v Punch

- When using Punch and Combine, Double Copies, or Auto Reduce/Enlarge, the message "Blank part will appear. Check orientation." may appear because of the orientation of the original and the copy paper. If this occurs, change the orientation of the copy paper.
- Since punch holes are made in each copy, the punch hole positions vary slightly.
- Punchable paper sizes are as follows:

With 2 Tray finisher			
Punch kit type			
2 & 4 holes type	2 holes		A3-A5, 11" × 17"-5 ¹ / ₂ " × 8 ¹ / ₂ "
			A4-A5, 8 ¹ / ₂ " × 11"-5 ¹ / ₂ " × 8 ¹ / ₂ "
	4 holes		A3, B4 JIS, 11" × 17"
			A4, B5 JIS, 8 ¹ / ₂ " × 11"
4 holes type	4 holes		A3-A5, 11" × 17"-5 ¹ / ₂ " × 8 ¹ / ₂ "
			A4-A5, 8 ¹ / ₂ " × 11"-5 ¹ / ₂ " × 8 ¹ / ₂ "
2 & 3 holes type	2 holes		A3-A5, 11" × 17"-5 ¹ / ₂ " × 8 ¹ / ₂ "
			A4-A5, 8 ¹ / ₂ " × 11"-5 ¹ / ₂ " × 8 ¹ / ₂ "
	3 holes		A3, B4 JIS, 11" × 17"
			A4, B5 JIS, 8 ¹ / ₂ " × 11"

- The punch hole positions change according to the orientation of the paper selected.

v Duplex

- You cannot use the following copy paper with this function:
 - Paper smaller than A5  , 5¹/₂" × 8¹/₂"  (possible on A5  , 5¹/₂" × 8¹/₂" )
 - Paper thicker than 105 g/m², 28 lb.
 - Paper thinner than 64 g/m², 17 lb.
 - Translucent paper
 - OHP transparencies
 - Label paper (adhesive labels)
 - Postcards

- When an odd number of originals is placed in the ADF, the back of the last page of copied paper is blank.
- During copying, the image is shifted to allow for the binding margin.
- The following paper sizes can be duplexed: A3, B4 JIS, A4, B5 JIS, A5, 11" × 17", 8¹/₂" × 14", 8¹/₂" × 11"

v Combine

- In this mode, the machine selects the reproduction ratio automatically. This reproduction ratio depends on copy paper sizes and the number of originals.
- The reproduction ratios you can specify are 25–400%.
- If the calculated ratio is under the minimum ratio, it is automatically adjusted to within available range. However, with some ratios, parts of the image might not be copied.
- You cannot use custom size paper.
- If the orientation of originals is different from that of the copy paper, the machine will automatically rotate the image by 90° to make copies properly.
- If the number of originals placed is less than the number specified for combining, the last page segment is left blank as shown.

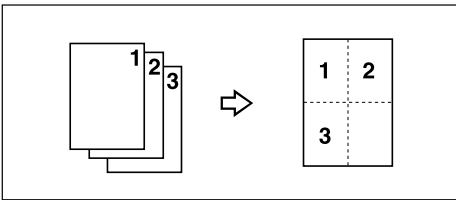

v Booklet/Magazine

- The machine sets the reproduction ratio automatically to meet the paper size and copies the originals together onto the paper.
- The reproduction ratios you can specify are 25–400%.
- If the calculated ratio is under the minimum ratio, it is automatically adjusted to within available range. However, with some ratios, parts of the image might not be copied.
- If the orientation of originals is different from that of the copy paper, the machine will automatically rotate the image by 90° to make copies properly.
- You cannot copy with originals different in size and orientation.
- If the number of originals scanned is less than a multiple of 4, the last page is copied blank.
- In Magazine mode, the copying may take some time after scanning originals.
- When the optional booklet finisher is installed, if you select Saddle Stitch function in Magazine mode, the machine staples and folds the paper in the centre, then delivers the paper folded.

v Image Repeat

Depending on the paper size, ratio, and orientation, parts of repeated images may not be copied.

v Centring

Though the original is set to a different orientation from the paper loaded, the machine will not rotate the image by 90° (Rotate copy).

v Erase

The width of the erased margin varies depending on the reproduction ratio. If the size of the original is different from sizes listed in the following chart, the erased margin might be shifted:

- Metric version

Where original is placed	Paper size and orientation
Exposure glass	A3☐, B4 JIS☐, A4☐☐, B5 JIS☐☐, A5☐☐, 8 ¹ / ₂ " × 13"☐
ADF	A3☐, B4 JIS☐, A4☐☐, B5 JIS☐☐, A5☐☐, 8 ¹ / ₂ " × 13"☐

- Inch version

Where original is placed	Paper size and orientation
Exposure glass	11" × 17"☐, 8 ¹ / ₂ " × 14"☐, 8 ¹ / ₂ " × 11"☐☐
ADF	11" × 17"☐, 8 ¹ / ₂ " × 14"☐, 8 ¹ / ₂ " × 11"☐☐, 10" × 14"☐, 5 ¹ / ₂ " × 8 ¹ / ₂ "☐

v Margin Adjustment

- If you set a binding margin that is too wide, part of the image may not be copied.
- When making copies in Combine mode, the binding margin is added to the copies after the combination is finished.

v Background Numbering

The numbers appear to overlap the copied image in some cases.

v Preset Stamp

- You can change the size and density of the stamp with User Tools. Depending on the setting, density may change.
- Depending on paper size, if you change the stamp size, parts of the stamp might not be printed.

v Date Stamp

When using Combine mode, the date stamp is printed as follows:

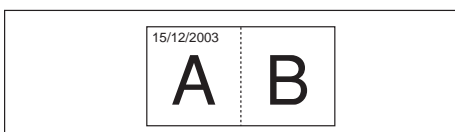

v **Page Numbering**

When page numbering is used with Combine mode, page numbers are printed as follows:

- Page Numbering per original:
Combined with 1 Sided / 2 Sided in the Combine function

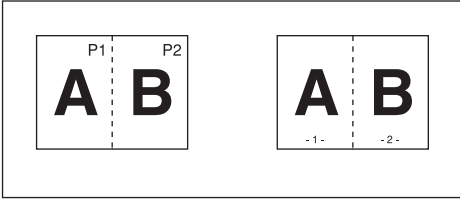

Combined with the Magazine or Booklet function

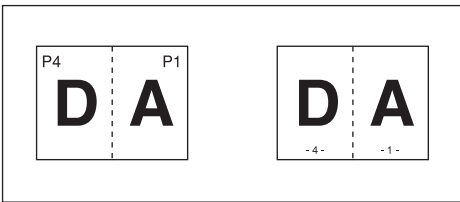

- Page Numbering per copy:
Combined with 1 Sided / 2 Sided in the Combine function

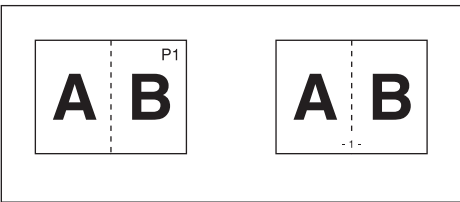

If you combine this function with the Duplex (Top to Top) function and select [P1, P2] or [1/n, 2/n], page numbers on the back are printed as follows:

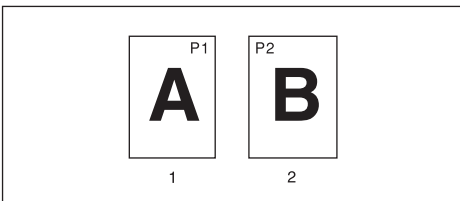

1. Front
2. Back

v Front Cover, Front/Back Cover

- If Blank mode is selected, the cover will not be counted as a copy.
- Front and back covers are two-sided copied depending on the settings made in Display Time in Cover Sheet Tray of User Tools (System Settings).
 - If Display Time is selected to the At Mode Selected, settings made in Cover Sheet Tray has the priority.
 - If Display Time is selected to Full Time, settings made in Paper Type has the priority.
See “Paper Type” and “Cover Sheet Tray” in “Tray Paper Settings”, *General Settings Guide*.

v Designate

When Combine mode (“1 Sided→2 Sided”) has been selected, the page numbers you designate will always be copied onto the front of copies in the same way as Chapter mode.

v Slip Sheets

If you do not copy onto slip sheets, they are excluded from the number of copies counted.

INDEX

-
- 1 sided → 2 sided, 43
 - 2 sided → 1 sided, 43
 - 2 sided → 2 sided, 43
 - 90° turn, 11

A

- Accessing user tools
 - copy/Document Server features*, 89
- Adjusting
 - copy image density*, 21
- Auto
 - image density*, 21
 - paper select*, 23
 - reduce/enlarge*, 28
 - tray switching*, 90
- Auto paper select, 24

B

- Background numbering, 98
- Basic procedure, 15
- Batch mode, 12
- Border erase, 56

C

- Centre/border erase, 57
- Centre erase, 57
- Change
 - stamp position*, 61, 64
 - style of date*, 64
- Changing
 - number of sets*, 33
 - stamp density*, 60
 - stamp position*, 66
 - stamp position, size and density*, 60
 - stamp size*, 60
 - stored program*, 74
- Check Modes key, 4
- Clear Modes key, 4
- Clear/Stop key, 5
- Combination chart, 103
- Combined auto and manual image density, 21
- Control panel, 4
- Copier/document server features, 83

- Copy functions, 21
 - adjusting copy image density*, 21
 - auto reduce/enlarge*, 28
 - background numbering*, 59
 - booklet/magazine*, 50
 - centring*, 54
 - chapter*, 70
 - covers*, 68
 - date stamp*, 63
 - designate*, 69
 - directional magnification (%)*, 29
 - directional size magnification (mm)*, 30
 - double copies*, 53
 - duplex*, 43
 - image repeat*, 52
 - margin adjustment*, 58
 - one-sided combine*, 45
 - page numbering*, 65
 - positive/negative*, 55
 - preset reduce/enlarge*, 26
 - preset stamp*, 59
 - selecting copy paper*, 23
 - selecting original type setting*, 22
 - series copies*, 48
 - size magnification*, 28
 - slip sheets*, 71
 - sort*, 31
 - stack*, 34
 - staple*, 35
 - two-sided combine*, 47
 - user stamp*, 60
 - zoom*, 27
- Copying, 15
 - interrupt copy*, 16
 - job preset*, 17
 - original beeper*, 16
- Copying from bypass tray
 - onto custom size paper*, 18, 19
 - onto special paper*, 20
 - onto standard size paper*, 19
- Covers
 - front*, 69
 - front/back*, 69
- Create margin mode, 26

D

- Date stamp, 99
 - change position*, 64
 - change style*, 64
 - font*, 100
 - position and original orientation*, 63
 - size*, 100
- Deleting
 - program*, 74
 - user stamp*, 62
- Display panel, 4
- Document Server, 72

E

- Edit, 85, 95, 96
 - 1 sided → 2 sided auto margin – T to B*, 96
 - 1 sided → 2 sided auto margin – T to T*, 96
 - back margin – left/right*, 95
 - back margin – top/bottom*, 95
 - copy order in combine*, 98
 - double copies separation line*, 97
 - erase border width*, 96
 - erase centre width*, 96
 - erase original shadow in combine*, 96
 - front cover copy in combine*, 97
 - front margin – left/right*, 95
 - front margin – top/bottom*, 95
 - image repeat separation line*, 96
 - separation line in combine*, 97
- Energy Saver key, 4
- Erase, 55
 - border*, 55
 - border width*, 96
 - centre*, 55
 - centre/border*, 56
 - centre width*, 96
 - original shadow in combine*, 96

F

- Font, 100
- Format, 99
- Function status indicator, 5

G

- General Features, 83, 84, 90, 92, 93
 - auto image density priority*, 91
 - auto paper select priority*, 90
 - auto tray switching*, 90
 - change initial mode*, 92
 - copy function key*, 93
 - copy orientation in duplex mode*, 92
 - copy quality*, 91
 - Document Server storage key*, 93
 - duplex mode priority*, 92
 - job end call*, 92
 - max. copy quantity*, 92
 - original orientation in duplex mode*, 92
 - original type display*, 90
 - original type priority*, 90
 - paper display*, 90
 - tone – original remains*, 92
- Generation copy, 22

I

- Indicators, 4
- Input/Output, 88, 101
 - auto sort*, 101
 - letterhead setting*, 102
 - memory full auto scan restart*, 101
 - rotate sort – auto paper continue*, 101
 - SADF auto reset*, 101
 - select punch type*, 102
 - select stack function*, 102
 - select stapling position*, 102
 - switch to batch (SADF)*, 101
- Interrupt key, 4

K

- Key
 - check modes*, 4
 - clear modes*, 4
 - clear/stop*, 5
 - energy saver*, 4
 - interrupt*, 4
 - program*, 4
 - sample copy*, 5
 - # (sharp)*, 5
 - start*, 5
 - user tools/counter*, 4

M

- Main power indicator, 4
- Manual image density, 21
- Manual paper select, 24
- Messages, 75
- Missing image area, 9
- Mixed size mode, 13

N

- Non-compatible originals for Auto Document Feeder, 7
- Number keys, 5

O

- OHP transparencies, 71
- One-sided combine
 - 1 sided 2 pages → combine 1 side, 45
 - 1 sided 4 pages → combine 1 side, 45
 - 1 sided 8 pages → combine 1 side, 45
 - 2 sided 1 page → combine 1 side, 45
 - 2 sided 2 pages → combine 1 side, 45
 - 2 sided 4 pages → combine 1 side, 45
- Operation switch, 4
- Original
 - beeper, 16
 - combine, 45
 - copy orientation, 45
 - orientation, 10
 - orientation and completed copies, 44
 - orientation in duplex mode, 92
 - type display, 90
 - type priority, 90
- Originals, 7

P

- Page numbering
 - duplex back page stamping position, 100
 - first printing page, 66
 - font, 100
 - page numbering in combine, 100
 - position, 66
 - size, 100
 - stamp format, 100
 - stamp on designating slip sheet, 100
 - stamp position, 101
 - start number, 66
 - superimpose, 101
- Pale, 22
- Photo, 22

Placing

- custom size originals, 14
- originals, 7, 10, 11, 12, 14
- originals in Auto Document Feeder, 12
- originals on exposure glass, 11

Preset stamp, 98

- changing density, 60
- changing position, 60
- changing size, 60
- format, 99
- language, 98
- position, 98
- position and original orientation, 60
- priority, 98

Program key, 4

Programs, 73

Punching copies, 41

Q

Quitting User Tools, 89

R

Recalling a program, 74

Reproduction Ratio, 84

Reproduction ratio, 94

- enlarge, 94
- priority setting – enlarge, 94
- priority setting – reduce, 95
- ratio for create margin, 95
- reduce, 94
- R/E priority, 95
- shortcut R/E, 94

Rotated copy, 25

S

SADF mode, 13

Sample copy, 33

Sample copy key, 5

Screen contrast knob, 4

Selecting

- copy paper, 23
- original type setting, 22

Series copies

- book → 1 sided, 48
- book → 2 sided, 49
- front & back → 2 sided, 49

(sharp) key, 5

Size, 100

Sizes

- detectable by auto paper select, 8
- difficult to detect, 9
- of recommended originals, 7

Sort, 31
 rotate sort, 31
 shift sort, 32
Specifications, 103
Stack, 34
Stamp, 98
 background numbering, 59
 date stamp, 63
 format, 99
 language, 98
 page numbering, 65
 position, 98, 99, 100
 position and original orientation, 61,
 63, 65
 preset stamp, 59
 priority, 98
 setting, 100
 user stamp, 60
Standard orientation, 11
Stapling position and original setting, 35
Start key, 5
Storing
 data, 72
 program, 73
Superimpose, 100
Supplementary information, 104
 background numbering, 113
 booklet/magazine, 112
 bypass tray copy, 104
 centring, 113
 combine, 112
 date stamp, 113
 designate, 115
 directional size magnification, 105
 duplex, 111
 erase, 113
 front/back cover, 115
 front cover, 115
 image repeat, 113
 margin adjustment, 113
 mixed size mode, 104
 page numbering, 114
 preset enlarge/reduce, 104
 preset stamp, 113
 punch, 111
 rotate sort, 106
 size magnification, 105
 slip sheets, 115
 sort, 106
 stack, 106
 staple, 108
 zoom, 105

T

Text, 22
Text/Photo, 22
Tone – original remains, 92
Troubleshooting, 75
 memory is full, 81
 you cannot make clear copies, 77
 you cannot make copies as you want, 78
 your machine does not operate as you want, 75
Two-sided combine
 1 sided 16 pages → combine 2 side, 47
 1 sided 4 Pages → combine 2 side, 47
 1 sided 8 pages → combine 2 side, 47
 2 sided 16 pages → combine 2 side, 48
 2 sided 4 pages → combine 2 side, 47
 2 sided 8 pages → combine 2 side, 47
Types of duplex copies, iii

U

User stamp, 99
 changing position, 61
 delete, 62
 format, 99
 position, 99
 position and original orientation, 61
 program, 61
 program/delete, 99
User Tools, 83
User Tools/Counter key, 4

W

Weights of recommended originals, 7
What you can do with this machine, iii

MEMO



FAX Option Type 2045e

Operating Instructions Facsimile Reference <Basic Features>



-
- 1 Getting Started
 - 2 Faxing
 - 3 Using Internet Fax Functions
 - 4 Programming
 - 5 Troubleshooting

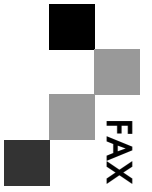

FAX Option Type 2045e Operating Instructions Facsimile Reference <Basic Features>

Introduction

This manual describes detailed instructions on the operation and notes about the use of this machine. To get maximum versatility from this machine all operators are requested to read this manual carefully and follow the instructions. Please keep this manual in a handy place near the machine.

Notes

Some illustrations in this manual might be slightly different from the machine.

Certain options might not be available in some countries. For details, please contact your local dealer.

Two kinds of size notation are employed in this manual. With this machine refer to the metric version.

Important

Contents of this manual are subject to change without prior notice. In no event will the company be liable for direct, indirect, special, incidental, or consequential damages as a result of handling or operating the machine.

Trademarks

Microsoft® and Outlook® are either registered trademarks or trademarks of Microsoft Corporation in the United States and/or other countries.

Adobe® and Acrobat® are registered trademarks of Adobe Systems Incorporated.

Other product names used herein are for identification purposes only and might be trademarks of their respective companies. We disclaim any and all rights in those marks.

NOTICE

NOTICE TO USERS (NEW ZEALAND)

- ① The grant of a Telepermit for any item of terminal equipment indicates only that Telecom has accepted that the item complies with minimum conditions for connection to its network. It indicates no endorsement of the product by Telecom, nor does it provide any sort of warranty. Above all, it provides no assurance that any item will work correctly in all respects with another item of Telepermitted equipment of a different make or model, nor does it imply that any product is compatible with all of Telecom's network services.
- ② This equipment is not capable, under all operating conditions, of correct operation at the higher speeds for which it is designed. Telecom will accept no responsibility should difficulties arise in such circumstances.
- ③ This equipment shall not be set up to make automatic calls to the Telecom "111" Emergency Service.
- ④ If a charge for local calls is unacceptable, the "Dial" button should NOT be used for local calls. Only the 7-digits of the local number should be dialled from your telephone. DO NOT dial the area code digit or the "0" prefix.
- ⑤ This equipment may not provide for the effective hand-over of a call to another device connected to the same line.
- ⑥ This device may be subject to ringing or bell tinkle when calls are made from another device on the same line. If this occurs, the problem should not be referred to the Telecom Faults Service.
- ⑦ This equipment should not be used under any circumstances, which may constitute a nuisance to other Telecom customers. For example, repeated attempts to make unsolicited sales offers to the same number or group of numbers, such as when a block of numbers terminate on the same PABX.
- ⑧ The call log incorporated in this equipment does not record all answered calls. The call log, therefore may not agree with the Telecom account which may include calls not shown on the log.
- ⑨ Not all telephones will respond to incoming ringing when connected to the extension socket.

Manuals for This Machine

The following manuals describe the operational procedures of this machine. For particular functions, see the relevant parts of the manual.

Note

- r Manuals provided are specific to machine type.
- r Adobe Acrobat Reader is necessary to view the manuals as a PDF file.
- r Two CD-ROMs are provided:
 - CD-ROM 1“Operating Instructions for Printer/Scanner”
 - CD-ROM 2“Scanner Driver & Document Management Utilities”

v **General Settings Guide**

Provides an overview of the machine and describes System Settings (paper trays, Key Operator Tools, etc.), Document Server functions, and troubleshooting.

Refer to this manual for Address Book procedures such as registering fax numbers, e-mail addresses, and user codes.

v **Network Guide (PDF file - CD-ROM1)**

Describes procedures for configuring the machine and computers in a network environment.

v **Copy Reference**

Describes operations, functions, and troubleshooting for the machine’s copier function.

v **Facsimile Reference <Basic Features>(this manual)**

Describes operations, functions, and troubleshooting for the machine’s facsimile function.

v **Facsimile Reference<Advanced Features>**

Describes advanced functions and settings for key operators.

v **Printer Reference 1**

Describes system settings and operations for the machine’s printer function.

v **Printer Reference 2 (PDF file - CD-ROM1)**

Describes operations, functions, and troubleshooting for the machine’s printer function.

v **Scanner Reference (PDF file - CD-ROM1)**

Describes operations, functions, and troubleshooting for the machine’s scanner function.

v **Manuals for DeskTopBinder V2 Lite**

DeskTopBinder V2 Lite is a utility included on the CD-ROM labeled “Scanner Driver & Document Management Utilities”.

- DeskTopBinder V2 Lite Setup Guide (PDF file - CD-ROM2)
Describes installation of, and the operating environment for DeskTopBinder V2 Lite in detail. This guide can be displayed from the **[Setup]** dialog box when DeskTopBinder V2 Lite is installed.
- DeskTopBinder V2 Lite Introduction Guide (PDF file - CD-ROM2)
Describes operations of DeskTopBinder V2 Lite and provides an overview of its functions. This guide is added to the **[Start]** menu when DeskTopBinder V2 Lite is installed.
- Auto Document Link Guide (PDF file - CD-ROM2)
Describes operations and functions of Auto Document Link installed with DeskTopBinder V2 Lite. This guide is added to the **[Start]** menu when DeskTopBinder V2 Lite is installed.

v **Manuals for ScanRouter V2 Lite**

ScanRouter V2 Lite is a utility included on the CD-ROM labeled “Scanner Driver & Document Management Utilities”.

- ScanRouter V2 Lite Setup Guide (PDF file - CD-ROM2)
Describes installation of, settings, and the operating environment for ScanRouter V2 Lite in detail. This guide can be displayed from the **[Setup]** dialog box when ScanRouter V2 Lite is installed.
- ScanRouter V2 Lite Management Guide (PDF file - CD-ROM2)
Describes delivery server management and operations, and provides an overview of ScanRouter V2 Lite functions. This guide is added to the **[Start]** menu when ScanRouter V2 Lite is installed.

v **Other manuals**

- PS3 Supplement (PDF file - CD-ROM1)
- Unix Supplement (Available from an authorized dealer, or as a PDF file on our Web site.)

Note

r The following software products are referred to using a general names:

- DeskTopBinder V2 Lite and DesktopBinder V2 Professional → DesktopBinder V2 Lite/Professional
- ScanRouter V2 Lite and ScanRouter V2 Professional (optional) → ScanRouter V2 Lite/Professional
- SmartNetMonitor for Admin and SmartNetMonitor for Client → SmartNetMonitor for Admin/Client

TABLE OF CONTENTS

NOTICE	i
Manuals for This Machine	ii
How to Read This Manual	1
Symbols	1

1. Getting Started

Control Panel	3
Reading the Display	5
Reading the display panel and using keys	5
Reading the destination list	7
Standby display	7
Communication display	8
User code entry display	9

2. Faxing

Transmission Modes	11
Switching between Memory Transmission and Immediate Transmission.....	12
Placing Originals	13
Placing a Single Original on the Exposure Glass.....	14
Bound original page order	15
Placing Originals in the Optional Auto Document Feeder (ADF)	15
Originals unsuitable for the optional Auto Document Feeder	16
Setting a Scan Area	16
Original sizes difficult to detect.....	19
Memory Transmission	20
Canceling a Memory Transmission	24
Before the Original Is Scanned	24
While the Original Is Being Scanned.....	24
While the Original Is Being Transmitted.....	24
Before the Transmission Is Started.....	25
Immediate Transmission	27
Canceling an Immediate Transmission	30
Before You Have Pressed the [Start] Key	30
After You Have Pressed the [Start] Key	30
Scan Settings	31
Resolution	31
Original Type.....	32
Image Density (Contrast)	33
Mixing Scan Settings for a Multiple Page Original	34
When placing originals on the exposure glass	35
When placing originals in the optional Auto Document Feeder.....	35
Specifying a Destination	36
Entering a Fax Number	36
Pause	37
Tone	37
Entering an E-mail Address	38
Using Destination Lists.....	39

Searching for a Destination	42
Search by Destination Name	42
Search by Fax Number	43
Search by E-mail Address.....	44
Specifying a Registration Number.....	45
Reception.....	47
Switching the Reception Mode.....	47
Receiving a Fax in Manual Reception Mode.....	48

3. Using Internet Fax Functions

Internet Fax Functions	49
Internet Fax Precautions	50
Functions Not Supported by E-mail Transmission	50
Functions Not Supported by E-mail Reception	51
Transmitting Internet Fax.....	52
Confirming Reception.....	58
Canceling a Transmission of an Internet Fax	59
Before the Original Is Scanned	59
While the Original Is Being Scanned In.....	59
After the Original Has Been Scanned In	60
Receiving Internet Fax.....	61
Auto E-mail Reception	61
Manual E-mail Reception	61
Received Images	62

4. Programming

Initial Settings and Adjustments	65
Programming.....	66
Editing	68
Deleting.....	69
Programming Fax Numbers and E-mail addresses.....	71

5. Troubleshooting

Adjusting the Volume	73
When the [Facsimile] Key Is Lit in Red.....	74
When Toner Runs Out.....	75
Error Messages and Their Meanings	76
Solving Problems.....	80
When Things Don't Go as Expected	82
INDEX.....	83

How to Read This Manual

Symbols

In this manual, the following symbols are used:

 **WARNING:**

This symbol indicates a potentially hazardous situation that might result in death or serious injury when you misuse the machine without following the instructions under this symbol. Be sure to read the instructions, all of which are included in "Safety Information", *General Settings Guide*.

 **CAUTION:**

This symbol indicates a potentially hazardous situation that might result in minor or moderate injury or property damage that does not involve personal injury when you misuse the machine without following the instructions under this symbol. Be sure to read the instructions, all of which are included in "Safety Information", *General Settings Guide*.

* The statements above are notes for your safety.

 **Important**

If this instruction is not followed, paper might be misfed, originals might be damaged, or data might be lost. Be sure to read this.

 **Preparation**

This symbol indicates information or preparations required prior to operating.

 **Note**

This symbol indicates precautions for operation, or actions to take after abnormal operation.

 **Limitation**

This symbol indicates numerical limits, functions that cannot be used together, or conditions under which a particular function cannot be used.

 **Reference**

This symbol indicates a reference.

[]

Keys that appear on the machine's display panel.

[]

Keys and buttons that appear on the computer's display.

[]

Keys built into the machine's control panel.

1. Getting Started

Control Panel

The actual machine control panel may differ from this illustration depending on installed optional units. This illustration has all options installed.

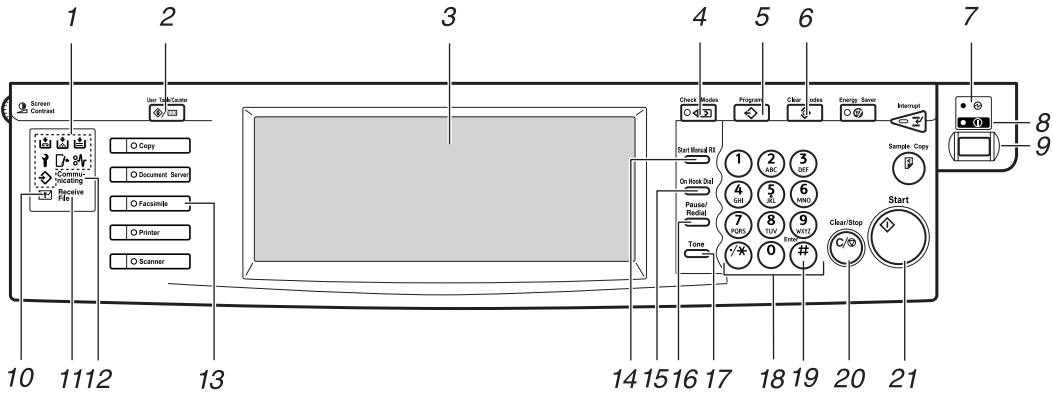

1. Indicators

Shows errors and machine status.

- ◆: Data In indicator
- ⚠: Service Call indicator
- ⚠: Misfeed indicator
- 🔧: Open Cover indicator
- 📎: Add Staple indicator
- 🖨️: Add Toner indicator
- 📄: Paper run-out indicator

See "Control Panel", *General Settings Guide*.

2. [User Tools/Counter] key

User Tools:

Press to enter User Tools mode. These tools allow you to customize default settings. See p.137 "Facsimile Features", *Facsimile Reference <Advanced Features>* .

Counter:

Displays and prints the total number of copied or printed pages.

3. Display Panel

This guides you through tasks and displays the machine status. Messages appear here.

4. [Check Modes] key

Press before pressing the [Start] key to check the settings selected for the fax about to be sent. See p.23 "Checking the transmission settings"

5. [Program] key

Enables you to program frequently used settings and recall previously programmed settings. See p.125 "Programs", *Facsimile Reference <Advanced Features>* .

6. [Clear Modes] key

Press to cancel the current settings.

7. Main Power indicator

This indicator lights when the main power switch is turned on.

8. On indicator

This indicator lights when the operation switch is turned on.

Important

r Do not turn off the main power switch while the On indicator stays lighted or is blinking. Neglecting this may damage the hard disk.

Note

r If the main power switch is on even when the On indicator is off, the machine will receive a fax message.

9. Operation switch

Press to turn the power on (the On indicator lights). To turn the power off, press this switch again (the On indicator goes off). See p.187 "Power Failure Report", *Facsimile Reference <Advanced Features>* .

Note

r The Operation switch does not function when the **[User Tools/Counter/Inquiry]** display is shown.

10. Confidential file indicator

Lights when a message is received into memory with Confidential Reception or Personal Box. See p.41 "Printing Personal Box Messages", *Facsimile Reference <Advanced Features>* .

Blinks when a Memory Lock file is received into memory. See p.38 "Printing a File Received with Memory Lock", *Facsimile Reference <Advanced Features>* .

11. Receive File indicator

Lights when a message other than a Confidential Reception or Memory Lock file is received. See p.86 "Substitute Reception", *Facsimile Reference <Advanced Features>* .

When Reception File Setting is set to Store, also lights when a message is received. See p.184 "Storing or Printing Received Documents", *Facsimile Reference <Advanced Features>* .

12. Communicating indicator

Lights during transmission or reception.

13. **[Facsimile]** key

Press to switch to facsimile mode.

- Lights up in yellow
Facsimile mode has been selected.
- Lights up in green
Printing while in facsimile mode.
- Lights up in red
Lights up whenever a facsimile error occurs. Press the **[Facsimile]** key to display the error message and take appropriate action. See p.74 "When the **[Facsimile]** Key Is Lit in Red".

14. **[Start Manual RX]** key

Press when Manual Reception is set. See p.48 "Receiving a Fax in Manual Reception Mode".

15. **[On Hook Dial]** key

Press when you want to dial while hearing tone from the internal speaker. See p.56 "On Hook Dial", *Facsimile Reference <Advanced Features>* .

16. **[Pause/Redial]** key

Pause:

Inserts a pause when you are dialing or storing a fax number. A pause cannot be inserted as the first digit. See p.37 "Pause".

Redial:

Press to redial one of the last ten numbers. See p.47 "Redial", *Facsimile Reference <Advanced Features>* .

17. **[Tone]** key

Press to send tonal signals down a pulse dialing line. See p.37 "Tone".

18. Number keys

Use to dial fax numbers, or enter the number of copies.

19. **[#]** key (Enter key)

Registers entered contents or settings.

20. [Clear/Stop] key

Clear:

Cancels entered numbers or characters.

Stop:

Interrupts the current operation (transmission, scanning, copying, or printing).

21. [Start] key

Press to start faxing, or printing reports, or lists.

1

Reading the Display

The display shows you the machine status, messages, and guides you through operations.

Note

This machine automatically returns to standby mode if you do not use the machine for a certain period of time. You can select the period using the Fax Reset Timer. See “Timer Settings”, *General Settings Guide*.

Reading the display panel and using keys

Display contents will differ depending on installed optional units.

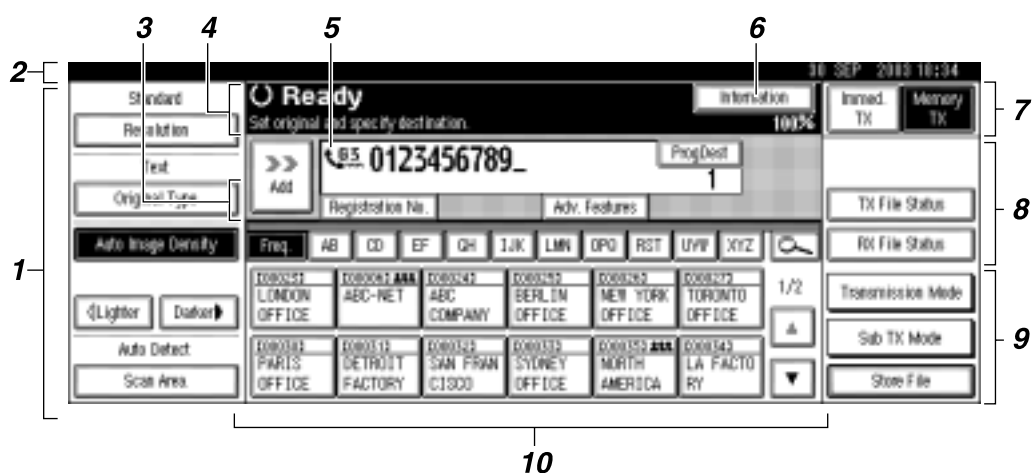
v Initial Display

1. Allows you to select scanning conditions and sizes.

2. Displays the date and time, the name and facsimile number of a destination when transmitting, and the size of the original.

3. Press to add a destination by entering a fax number or e-mail address.

4. Displays messages and the machine status.

5. Displays the entered number of a destination. When adding destinations using the number keys, press [Add].

6. Press to display various information about transmission.

7. Switches transmission mode between Memory Transmission and Immediate Transmission.

8. Displays Quick Operation keys set for often used functions. [TX File Status] and [RX File Status] are preset.

9. Displays various functions for transmitting.

10. Displays the destination lists of programmed destinations.

v Initial Display (When Internet Fax Setting is ON)



1. Switches the destination between fax number and e-mail address.

Note

- r To use the Internet Fax functions, the optional printer/scanner unit is required.
- r You also need to set Internet Fax Setting to ON in Fax Features. See p.145 "E-mail Settings", *Facsimile Reference <Advanced Features>* .

Reading the destination list

When using the facsimile function, only fax and Internet Fax destinations programmed in the Address Book appears.

v Destination List

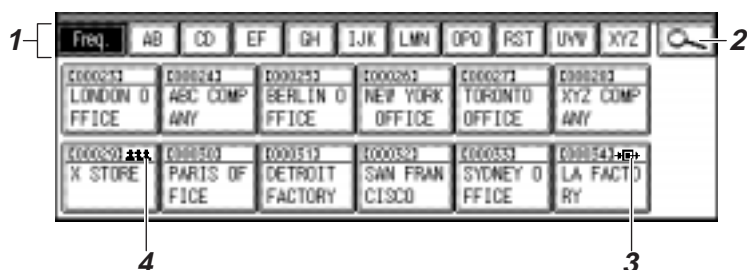

1. Title word keys appear. Allows you to switch from one page (display) to another on the destination list.

2. Allows you to search for a destination by fax number, e-mail address, or destination name.

3. Appears on Quick Dial keys programmed as a transfer station.

4. Appears on Quick Dial keys programmed with a group of destinations.

Standby display

While the machine is in standby mode (immediately after the **[Facsimile]** key is pressed or after the **[Clear Modes]** key is pressed), the following display appears.

v Memory Transmission (initial display)



v Immediate Transmission



Note

r To return to standby mode, do one of the following:

- If you have placed the original in the optional Auto Document Feeder (ADF) and have not pressed the **[Start]** key, remove the original.
- If you have not placed an original, press the **[Clear Modes]** key.
- If you are in User Tools mode, press the **[User Tools/Counter]** key.

Communication display

While communicating, the machine status is displayed.

v Memory Transmission (fax transmission)



Note

r While e-mail is being sent, the "Sending E-mail..." message appears.

v Reception



Note

- Even when the machine is being used as a copier, printer, or scanner, the sender name or number will appear for received faxes.

v Immediate Transmission**User code entry display**

When the following message appears on the display, User Code Management is active. Enter a user code to deactivate User Code Management.



The machine can be set up so that no one can use it without entering a user code. This prevents unauthorized people from sending fax messages and helps track the activity of each user or department.

Note

- You can specify a user code with "System Settings". See "Registering a New User Code", *General Settings Guide*.
- Even when User Code Management is on, you can still receive and print fax messages as normal.

1 Enter a user code of up to eight digits using the number keys.

2 Press [#].

Note

- If an unprogrammed user code is entered, the display returns to that of step **1**.

2. Faxing

Transmission Modes

There are two types of transmission:

- Memory Transmission
- Immediate Transmission

v Memory Transmission

Transmission starts automatically after the original has been stored in memory. It is a convenient method for when you are in a hurry and want to take the document away with you. You can also send the same original to several destinations (broadcasting).

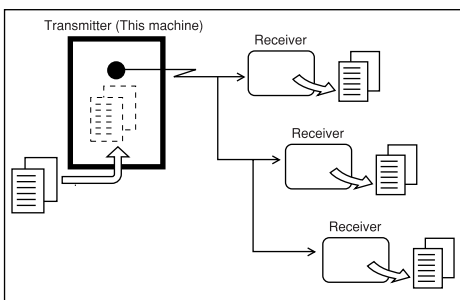

v Immediate Transmission

Immediately dials the destination number, and while reading the original, sends it. It is very convenient when you want to send an original quickly or when you want to check the destination you are sending to. When using this type of transmission, the original is not stored in memory. You can only specify one address.

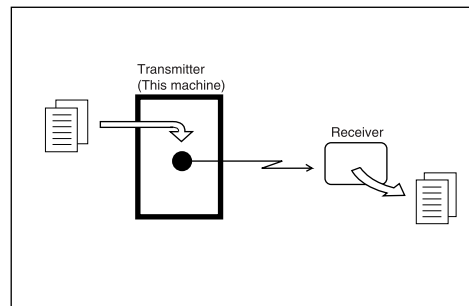

Important

- r If power outage lasts about an hour, or the machine is disconnected from the power outlet for about an hour, documents stored in the fax machine's memory are deleted. If any document is deleted, the Power Failure Report is automatically printed out when the main power switch is turned on. Use this report to check which documents were deleted. Simply turning off the power by pressing the Operation switch does not delete stored documents. See p.187 "Power Failure Report", *Facsimile Reference <Advanced Features>* .

Note

- You can use Parallel Memory Transmission that dials while the original is being scanned. See p.77 “Parallel Memory Transmission”, *Facsimile Reference <Advanced Features>* .

2

Switching between Memory Transmission and Immediate Transmission

Check the display to see which mode is currently active. You can change transmission mode by pressing **[Immed. TX]** or **[Memory TX]**.

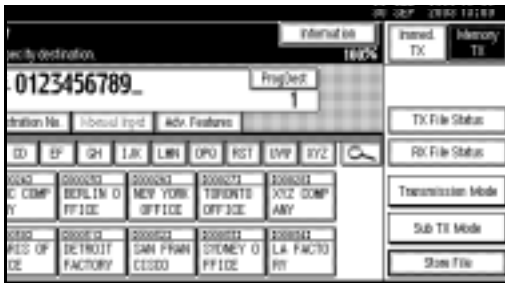

Note



- You can select the transmission mode that is operative when the machine is turned on with **[Memory/Immed. Transmission Switch]** under Gen. Settings/Adjust. See p.142 “General Settings/Adjustment”, *Facsimile Reference <Advanced Features>* .
- You can have the machine return to default mode after each transmission using **[Scan End Reset]** under Gen. Settings/Adjust. See p.142 “General Settings/Adjustment”, *Facsimile Reference <Advanced Features>* .

Placing Originals

You can place the originals either in the optional ADF or on the exposure glass. Some types of originals are unsuitable for the ADF, so they must be placed on the exposure glass.

Which way you place the original depends on its size and whether you are using the ADF or the exposure glass. See p.19 "Original sizes difficult to detect".

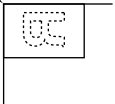

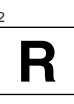
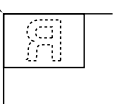
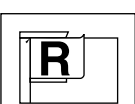
- v **How to place A4, B4 JIS (Japanese Industrial Standard), A3, 8¹/₂"×11", 8¹/₂"×14", and 11"×17" size originals**

Original	Where original is placed	
	Exposure glass	The ADF
*1 		
*2 		

Note

- r When you place originals as shown in the above illustration, the fax header will be printed on received faxes at the destination as follows:
 - *1 On the top of the fax
 - *2 On the left side of the fax

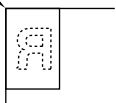
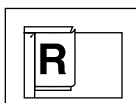
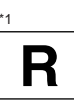
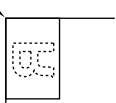
- v **How to place A5 and B5 JIS size originals**

Original	Where original is placed	
	Exposure glass	The ADF
*2 		
*1 		

Limitation

- r If you place A5 size documents on the exposure glass, they will not be detected. A5 size documents placed in the ADF are sent. See p.19 "Original sizes difficult to detect".

Note

- r When you place originals as shown in the above illustration, the fax header will be printed on the received faxes at the destination as follows:
 - *1 On the top of the fax
 - *2 On the left side of the fax
- r When sending a fax, the image output at the other end depends on the size and orientation of paper used in the receiver's terminal. If the receiver does not use paper of the same size and orientation as that of the original, the fax image may be reduced in size, trimmed at both edges, or divided into two or more sheets. When sending an important original, we recommend you ask the receiver about the size and orientation of the paper used in their terminal.

- r When sending an original of irregular (i.e. custom) size or part of a large original, you can specify the scan area precisely. See p.16 “Setting a Scan Area”.
- r Custom size documents are scanned as regular size documents, so the receiver may find extra blank margins or edges of images missing. If you specify a scan area, only that area will be scanned regardless of actual document size.
- r Make sure that all ink, correcting fluid etc., has completely dried before placing your original. If it is still wet, the exposure glass will be marked and those marks will appear on the received image.
- r If you place an A4 size original in the portrait orientation, the machine rotates the image by 90 degrees before sending. See p.79 “Transmission with Image Rotation”, *Facsimile Reference <Advanced Features>*.
- r You can send the first pages from the exposure glass then the remaining pages from the ADF. After you have removed the last page from the exposure glass, insert the remaining pages in the ADF, and then press the **[Start]** key.
- r When using the Internet Fax function, documents transmitted are sent at A4 width. Documents larger than A4 are reduced to A4 width.

Reference

For how to place two-sided documents, see p.62 “Two-Sided Transmission (Double-Sided Transmission)”, *Facsimile Reference <Advanced Features>*.

For acceptable types of originals, see p.196 “Acceptable Types of Originals”, *Facsimile Reference <Advanced Features>*.

Placing a Single Original on the Exposure Glass

Place originals that cannot be placed in the optional ADF, such as a book, on the exposure glass one page at a time.

- 1** Lift the exposure glass cover or the ADF by at least 30 degrees.

Note

- r If you do not lift the ADF by at least 30 degrees, the original size will not be detected.

- 2** Place the original face down and align its upper left corner with the reference mark at the upper left corner of the exposure glass.

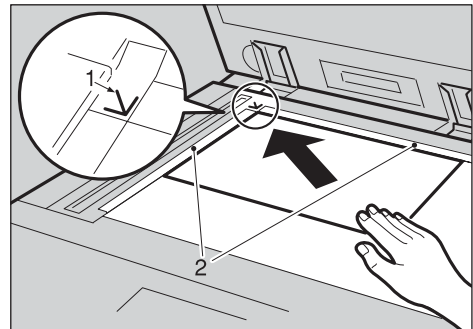

- 1.** Positioning mark

- 2.** Scale

- 3** Lower the ADF.

Note

- r When setting a bound original, the received image may contain some black areas. To reduce this effect, hold down the original to prevent the bound part from rising.

Bound original page order

When setting bound originals (books, magazines, etc.), you can select to have either the left page or right page sent first. See p.61 "Book Fax", *Facsimile Reference <Advanced Features>* .

Note

- r You can select whether the left page or right page is sent first. See p.159 "User Parameters", *Facsimile Reference <Advanced Features>* (switch 06, bit 6).

Placing Originals in the Optional Auto Document Feeder (ADF)

Use the ADF to scan in a stack of originals in one operation. The ADF can handle both one-sided and two-sided originals.

Limitation

- r Place all the originals to be sent in a single stack.
- r You cannot place originals in the ADF one page at a time or in sheaves.

Note

- r The maximum document length is 1200 mm (47").
- r If you send documents longer than 420 mm (17"), specify the area to be scanned. If you send such documents frequently, select Long Document mode with the User Parameters. If a jam occurs, the document might be damaged because scanning will not stop. See p.16 "Setting a Scan Area". See p.159 "User Parameters", *Facsimile Reference <Advanced Features>* (switch 14, bit 1).

- r Documents longer than 800 mm (32") must be sent by memory transmission (immediate transmission is not possible).
- r If your original is bent or folded, flatten it before you place it.
- r When sending thin originals, place them on the exposure glass.
- r If an original jammed, press the **[Clear/Stop]** key, and then slowly remove the original.
- r You can check information about the sizes and number of originals that can be placed in the ADF. See p.196 "Acceptable Types of Originals", *Facsimile Reference <Advanced Features>* .

1 Adjust the document guide to match the size of the originals.

2 Align the edges of the originals and stack them in the ADF face up.

Zewh060E.eps

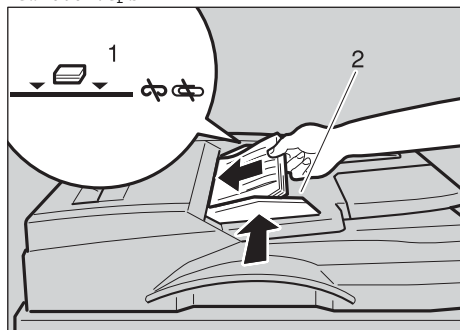

1. Limit mark

2. Document guide

Originals unsuitable for the optional Auto Document Feeder

Do not place the following types of originals in the ADF because they may be damaged. Place them on the exposure glass instead.

- Originals in unacceptable sizes (See p.196 "Acceptable Types of Originals", *Facsimile Reference <Advanced Features>* .)
- Originals containing staples or clips
- Perforated or torn originals
- Curled, folded, or creased originals
- Pasted originals
- Originals with any kind of coating, such as thermosensitive paper, art paper, aluminum foil, carbon paper, or conductive paper
- Originals with index tabs, tags, or other projecting parts
- Sticky originals, such as translucent paper
- Thin and soft originals
- Originals of inappropriate weight (See p.196 "Acceptable Types of Originals", *Facsimile Reference <Advanced Features>* .)
- Originals in bound form, such as books
- Transparent originals, such as OHP transparencies or translucent paper

Setting a Scan Area

Normally, a placed document is scanned according to the automatically detected size. If a scan area is specified, the document is scanned accordingly. Thus, documents can be sent without extra space or blank margins.

v Auto Detect









Detects the size of the first page and scans all pages using that size. If you want to scan originals of different sizes, use the Mixed Original Sizes function.

Note

- r If the machine cannot detect the original size, a confirmation message appears. Replace the original.

v Regular

The placed document is scanned according to specified size regardless of actual size.

The sizes that can be specified are A4  , B4 JIS , A3 , 8¹/₂"×11"  , 8¹/₂"×14" , and 11"×17" .

v Area

Enter the area to be scanned. Only the area in the specified size is scanned regardless of the actual size of a placed document. See p.152 "Programming, Changing and Deleting a Scan Size", *Facsimile Reference <Advanced Features>* .

v Mixed Original Sizes

Select this to individually scan the size of originals loaded in the ADF. For example, when A4 and B4 JIS size originals are sent together, usually all are sent using the size of the first original. By selecting Mixed Original Sizes, the machine scans and sends each document according to its size.

Note

- r To cancel the selected scan area, select **[Auto Detect]**. See p.18 "Specifying Auto Detect".
- r When using the Mixed Original Sizes, the machine sends the originals by memory transmission.
- r When using the Mixed Original Sizes, rotation transmission is disabled. See p.77 "More Transmission Functions", *Facsimile Reference <Advanced Features>*.

1 Place the originals, and then select any scan settings you require.

Note

- r When placing different size originals into the ADF, adjust the document guide to the largest original.
- r Small-size originals may be sent at a slight slant since they do not match the document guide.

2 Press [Scan Area].



3 Select the scan area.

Specifying standard sizes

A Press [Regular].



B Press the size of the originals to be sent, and then press [OK].



Note

- r 8¹/₂"x11" indicates LT. 8¹/₂"x14" indicates LG. 11"x17" indicates DLT.

C Press [OK].



The selected size is shown above the highlighted **[Scan Area]**.

Specifying programmed sizes

A Press [Area 1] or [Area 2].



B Press [OK].



"Area 1" or "Area 2" is shown above the highlighted [Scan Area].

Specifying Mixed Original Sizes

A Press [Mixed Original Sizes].



B Press [OK].



"Mixed Original Sizes" is shown above the highlighted [Scan Area].

Specifying Auto Detect

A Make sure that [Auto Detect] is selected.



Note

If it is not, press [Auto Detect].

B Press [OK].



"Auto Detect" is shown above [Scan Area].

4 Specify a destination and press the [Start] key.









Original sizes difficult to detect

The machine finds it difficult to detect the size of the following kinds of originals. If this happens, the receiving machine may not select print paper of the correct size.







- Documents placed on the exposure glass of sizes other than those listed in the table below
- Originals with index tabs, tags, or protruding parts
- Transparent originals, such as OHP transparencies or translucent paper
- Dark originals with dense text or drawings
- Originals which partially contain solid printing
- Originals which have solid printing around their edges
- Originals with glossy surfaces
- Bound originals of more than 10 mm (0.3") in thickness, such as books.

The following paper sizes are automatically detected in facsimile mode.

v Metric Version

Paper size where original is placed	A3 	8 1/2"×13" (F4)	B4 JIS 	A4  	B5 JIS  	A5  
Exposure glass	O	O	O	O	O	×
ADF	O	O	O	O	O	O

v Inch Version

Paper size where original is placed	11"×17" 	8 1/2"×14" 	8 1/2"×11"  	5 1/2"×8 1/2"  
Exposure glass	O	O	O	×
ADF	O	O	O	O

O - Auto detect

× - Unable to auto detect

Memory Transmission

In Memory Transmission mode, after you press the **[Start]** key, the machine does not dial the destination until all pages of your fax message have been scanned into memory (in contrast to Immediate Transmission, where the number is dialed first and pages are scanned and sent one by one).

Memory Transmission is useful because:

- You can take your original away from the machine without having to wait too long.
- While your message is being sent, other people can use the machine.
- You can send the same message to more than one place in a single operation (broadcasting).

Memory transmission mode has normal fax and Internet Fax functions.

Important

- r If there is a power failure (the main power switch is off) or the machine is unplugged out for more than one hour, all the documents stored in memory are deleted. As soon as the main power switch is turned on, the Power Failure Report is printed to help you identify deleted files. If you turn only the operation switch off, documents are not deleted. See p.187 “Power Failure Report”, *Facsimile Reference <Advanced Features>* .
- r We recommend you call the receiver and confirm with them when sending important messages.

Limitation

- r If memory is full (0% appears on the display), Memory Transmission is disabled. Use Immediate Transmission instead.

Note

- r Maximum number of destinations per Memory Transmission: 500.
- r Combined total number of destinations of standby messages stored in memory: 500 (2,000 with the optional fax function upgrade unit).
- r After the total number of programmed destination numbers exceeds 500 (2,000 with the optional fax function upgrade unit), you can perform only Immediate Transmission.
- r The number of documents you can store is 400. You can store 800 documents with the optional fax function upgrade unit.
- r The number of pages you can store in memory depends on the original images and the scan settings. You can store up to 320 standard pages (ITU-T #4 chart, Resolution: Standard, Original Type: Text). You can store up to 2,240 standard pages, with the optional expansion memory installed.
- r You can have the machine set to Memory Transmission mode or Immediate Transmission mode right after the power is turned on or the **[Clear Modes]** key is pressed. See p.142 “General Settings/Adjustment”, *Facsimile Reference <Advanced Features>* .

- r You can have the machine return to the default transmission mode (Memory Transmission or Immediate Transmission) after every transmission. You can change this so that the desired setting is maintained. See p.142 “General Settings/Adjustment”, *Facsimile Reference <Advanced Features>*.
- r When E-mail TX Results is programmed in a Quick Operation key, you can select whether transmission result report e-mail is sent to specified e-mail addresses. The destination for notification is selected from Internet Fax destinations in the destination list. See p.82 “Transmission Result Report (Memory Transmission)”, *Facsimile Reference <Advanced Features>* and p.142 “General Settings/Adjustment”, *Facsimile Reference <Advanced Features>*.
- r Allows you to specify fax number and e-mail address simultaneously.

Reference

p.52 “Transmitting Internet Fax”

- 1** Make sure that Memory TX is selected.

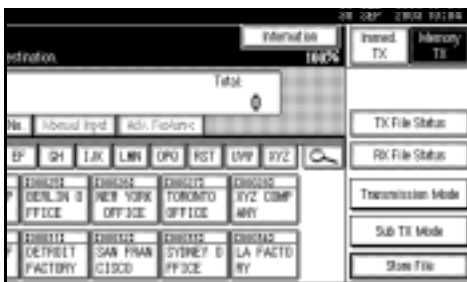

Note

- r If it is not, press **[Memory TX]**.

- 2** Place the original.

Note

- r You can send the first few pages from the exposure glass then the remaining pages from the ADF. After you remove the last page from the exposure glass, you have 60 seconds to insert the remaining pages in the ADF.
- r Note that you cannot place pages on the exposure glass after you have started using the ADF.
- r The original can be placed either in the ADF or on the exposure glass, until the **[Start]** key is pressed.

Reference

p.13 “Placing Originals”

- 3** Make the settings you require.



Reference

p.31 “Scan Settings”

p.32 “Original Type”

p.33 “Image Density (Contrast)”

4 Specify a destination.



2

Note

r If you make a mistake, press the **[Clear/Stop]** key, and then enter the correct number.

Reference

- p.36 "Entering a Fax Number"
- p.38 "Entering an E-mail Address"
- p.39 "Using Destination Lists"
- p.47 "Chain Dial", *Facsimile Reference <Advanced Features>*
- p.47 "Redial", *Facsimile Reference <Advanced Features>*

5 When sending the same original to several destinations (broadcasting), press **[Add]** to specify the destinations.



Note

- r You do not have to press **[Add]** when adding a destination using the destination list.
- r If you do not want to do a broadcast transmission, proceed to step **7**.

6 Specify a destination.



Note

- r Press **[Clear/Stop]** to switch the destination between fax number and e-mail address.
- r If you want to specify another destination, repeat steps **5** and **6**.

7 Press the **[Start]** key.

Note

- r Do not lift the ADF during scanning.
- After scanning, the standby display appears.

Lightbulb icon Sending originals using the exposure glass

- ① Make sure that Memory TX is selected. If it is not, press **[Memory TX]**.
- ② Place the first page of your original face down on the exposure glass.
- ③ Specify a destination.
- ④ Make the scan settings you require.
- ⑤ Press the **[Start]** key. The machine starts scanning.

- ⑥ Place the next original on the exposure glass within 60 seconds after the machine has finished scanning the first original.



- ⑦ Repeat steps ④ to ⑥ for all originals.
 ⑧ Place the last original, and then press [#].

💡 Checking the transmission settings

You can check the transmission settings (e.g. destination and transmission mode) on the display.

- ① Press the **[Check Modes]** key.

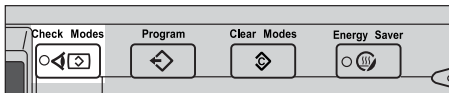

The following display appears.

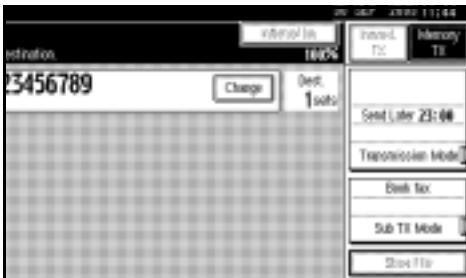

📌 Note

- r Press  to switch the destination between fax number and e-mail address.

- ② After checking the settings on the display, press the **[Check Modes]** key.

The display before the **[Check Modes]** key was pressed appears.

💡 Broadcasting Sequence

If you dial several destinations for the same message (broadcasting), the messages are sent in the order in which they were dialed. If the fax message could not be transmitted, the machine redials that destination after the last destination specified for broadcasting. For example, if you specify four destinations, A through D, for broadcasting, and if the lines to destinations A and C are busy, the machine dials the destinations in the following order: A, B, C, D, A, and C. See p.79 "Simultaneous Broadcast", *Facsimile Reference <Advanced Features>*

💡 Checking the Transmission Progress

To check which destinations the fax message has been sent to so far, print the TX file list. See p.25 "Printing a List of Files in Memory (Print TX File List)", *Facsimile Reference <Advanced Features>*

Canceling a Memory Transmission

Even when fax number and e-mail address are simultaneously specified, or only e-mail address is specified, you can cancel the mode using the same procedure. However, you cannot cancel the transmission of an Internet Fax document being sent.

Before the Original Is Scanned

Use this procedure to cancel a transmission before pressing the **[Start]** key.

1 Press the **[Clear Modes]** key.

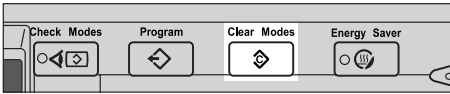

Note

- r When documents are placed in the ADF, you can cancel transmission simply by removing them.

While the Original Is Being Scanned

Use this procedure to cancel a transmission after pressing the **[Start]** key.

1 Press the **[Clear/Stop]** key.

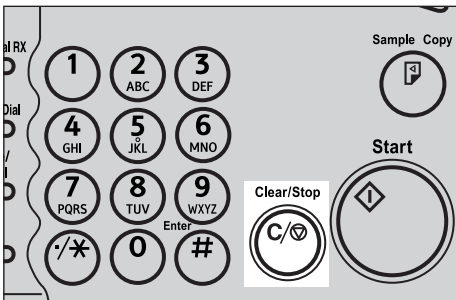

The machine stops scanning.

Note

- r You can also cancel scanning by pressing **[Stop Scanning]**.
- r Scanning may be completed while you are performing the cancel operation.

While the Original Is Being Transmitted

Note

- r If the transmission finishes while you are carrying out this procedure, it will not be canceled.
- r If you cancel a message while it is being sent, the transmission is halted as soon as you finish the cancellation procedure. However, some pages of your message may have already been sent and received at the other end.

1 Press the **[Clear/Stop]** key.

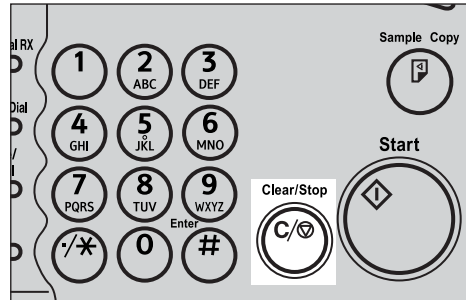

Note

- r You can also cancel a Memory Transmission by pressing **[Change/Stop TX File]**.

2 Select the file you want to cancel.

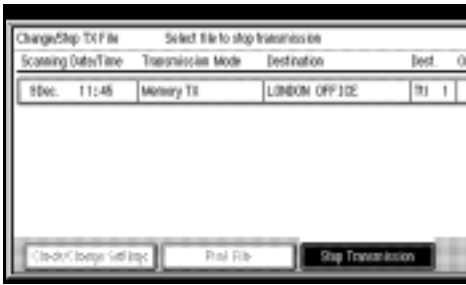

Note

r If the desired file is not shown, press [**▲ Prev.**] or [**▼ Next**] to find it.

3 Press [**Stop Transmission**].



Note

r To cancel another file, repeat steps **2** and **3**.
 r To cancel stopping transmission, press [**Save**].

4 Press [**Exit**].



The standby display appears.

Before the Transmission Is Started

Use this procedure to cancel a transmission after the original has been scanned.

1 Press [**Change/Stop TX File**].



The list of stored files being transmitted or waiting for transmission appears.

2 Select the file you want to cancel.



Note

r If the desired file is not shown, press [**▲ Prev.**] or [**▼ Next**] to find it.

3 Press [**Stop Transmission**].



 **Note**

- r To cancel another file, repeat steps **2** and **3**.
- r To cancel stopping transmission, press **[Save]**.

4 Press **[Exit]**.**2**

The standby display appears.

Immediate Transmission

With Immediate Transmission, when you press the **[Start]** key, the fax number is dialed immediately. The message is scanned and transmitted page by page without being stored in memory. This contrasts with Memory Transmission which scans all pages into memory before dialing the destination.

Immediate Transmission is useful if you want immediate confirmation that the message is being sent to the correct destination (just check the other terminal's Own Name or Own Fax Number on the control panel during transmission).

Limitation

Internet Fax is executed in only Memory Transmission that starts transmission automatically after storing documents in memory. If you specify Immediate Transmission in Internet Fax, the mode is switched to Memory Transmission while an e-mail address is being entered.

Note

You cannot send the same document to multiple destinations (broadcasting). Memory Transmission allows this function.

You can have the machine set to Memory Transmission mode or Immediate Transmission mode right after the power is turned on. See p.142 "General Settings/Adjustment", *Facsimile Reference <Advanced Features>* .

- r You can have the machine return to the default transmission mode (Memory Transmission or Immediate Transmission) after every transmission. You can change this so that the desired setting is maintained. See p.142 "General Settings/Adjustment", *Facsimile Reference <Advanced Features>* .
- r When E-mail TX Results is programmed in a Quick Operation key, you can send notification of memory transmission results to specified e-mail addresses. The destination for notification is selected from Internet Fax destinations in the destination list. See p.83 "Transmission Result Report (Immediate Transmission)", *Facsimile Reference <Advanced Features>* and p.142 "General Settings/Adjustment", *Facsimile Reference <Advanced Features>* .

1 Make sure that Immed. TX is selected.

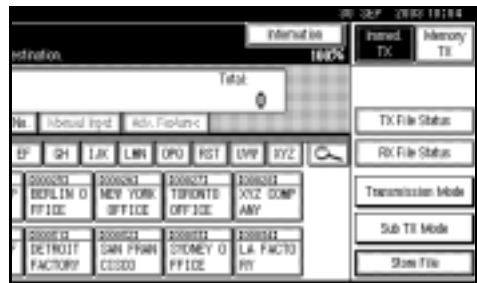

Note

If it is not, press **[Immed. TX]**.

2 Place the original.

Note

- r You can scan a few pages of your original from the exposure glass and the remaining pages from the ADF. When you have finished scanning from the exposure glass, remove the original from the exposure glass and place the remaining pages in the ADF within ten seconds.
- r To send two or more pages using the exposure glass, set them one page at a time.
- r The original can be placed whenever, before the **[Start]** key is pressed.

Reference

p.13 "Placing Originals"

3 Select the scan settings you require.



Reference

p.31 "Scan Settings"

4 Dial a destination.



Note

- r If you make a mistake, press the **[Clear/Stop]** key, and then enter the correct number.

Reference

p.36 "Specifying a Destination"
 p.47 "Chain Dial", *Facsimile Reference <Advanced Features>*
 p.47 "Redial", *Facsimile Reference <Advanced Features>*

5 Press the **[Start]** key.

Note

- r Do not lift the ADF during scanning.
- After transmission, the standby display appears.

Sending originals using the exposure glass

- ① Make sure that Immed. TX is selected. If it is not, press **[Immed. TX]**.
- ② Place the first page face down on the exposure glass.
- ③ Dial a destination.
- ④ Make the scan settings you require.
- ⑤ Press the **[Start]** key.

- ⑥ Place the next original on the exposure glass within 10 seconds after the machine has finished scanning the first original.

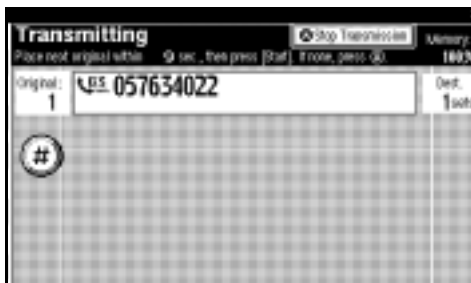

- ⑦ Repeat steps ④ to ⑥ for all originals.
- ⑧ Place the last original, and then press [#].



Canceling an Immediate Transmission

Before You Have Pressed the [Start] Key

2

- 1 Press the [Clear Modes] key.

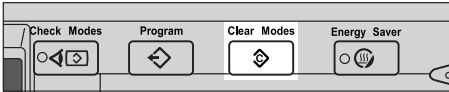

Note

- r When the original is placed in the ADF, you can also cancel an Immediate Transmission by removing the original.

After You Have Pressed the [Start] Key

- 1 Press the [Clear/Stop] key, and then remove the original.

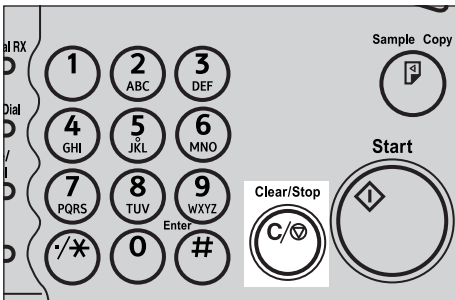

Note

- r You can also cancel an Immediate Transmission by pressing [Stop Transmission].
- r If the transmission finishes while you are carrying out this procedure, it will not be canceled.

Scan Settings

You may want to send many different types of fax messages. Some of these may be difficult to reproduce at the receiver's end. However, your machine has three settings that you can adjust to help you transmit your document with the best possible image quality.

- v **Resolution:**
Standard, Detail, Super Fine (optional)
- v **Original Type:**
Text, Text/Photo, Photo
- v **Image Density (Contrast):**
Auto Image Density, Manual Image Density (seven levels), Combined Auto and Manual Image Density

Resolution

Images and text are scanned into the machine by converting them to sequences of dots. The density of the dots determines the quality of the image and how long it takes to transmit. Therefore, images scanned at high resolution (Super Fine) have high quality but transmission takes longer. Conversely, low resolution (Standards) scanning results in lower quality but your original is sent more quickly. Select the setting that matches your needs based upon this trade off between speed and image clarity.

- v **Standard (8 x 3.85 lines/mm, 200 x 100 dpi)**
Select for originals containing normal size characters.

- v **Detail (8 x 7.7 lines/mm, 200 x 200 dpi)**
Select for originals containing small characters or when you require greater clarity. This resolution is twice as fine as Standard.

- v **Super Fine (optional expansion memory required: 16 x 15.4 lines/mm, 400 x 400 dpi)**
Select for originals with very fine details or when you require the best possible image clarity. This resolution is eight times finer than Standard.

Limitation

- r If the other party's machine does not support the resolution at which you are sending, this machine automatically switches to a resolution that is supported. You can check the resolution at which you sent actually. See p.154 "Printing the Journal", *Facsimile Reference <Advanced Features>*.
- r Sending with Super Fine resolution requires that your machine has the optional expansion memory, and the other party's machine has the capability to receive fax messages at Super Fine resolution.

Note

- r The machine supports Standard, Detail, and (with the optional expansion memory) Super Fine resolutions.

2

- r You can select the resolution type that is selected right after the machine is turned on or modes are cleared with **[Scan End Reset]** under **[Gen. Settings/Adjust]**. See p.142 “General Settings/Adjustment”, *Facsimile Reference <Advanced Features>* .
- r You can have the machine return to the resolution default setting after every transmission, with **[Text Size Priority]** under **[Gen. Settings/Adjust]**. See p.142 “General Settings/Adjustment”, *Facsimile Reference <Advanced Features>* .
- r In Internet Fax transmission, the original is scanned using "Detail" for transmission, even if you select "Super Fine".

1 Press **[Resolution]**.



2 Select the resolution you require, and then press **[OK]**.



Note

- r If you install the optional expansion memory, "Super Fine" will be displayed in the Resolution box.

Original Type

If your original contains photographs, illustrations, or diagrams with complex shading patterns or grays, select the appropriate original type to optimize image clarity.

v Text

Select **[Text]** to send high-contrast black-and-white image originals. Use this setting even if your original contains text and photographs, or if you only want to send clearer text.

v Text/Photo

Select **[Text/Photo]** to send an original containing both a high-contrast black-and-white image, such as text, and a halftone image, such as a photograph.

v Photo

Select **[Photo]** to send an original containing a halftone image, such as a photograph or a colour original.

Note

- r If you select **[Text/Photo]** or **[Photo]**, the transmission will take longer than when **[Text]** is selected.
- r If you send a fax message with **[Text/Photo]** or **[Photo]** and the background of the received image is dirty, reduce the density setting and resend the fax. See p.33 “Image Density (Contrast)”.
- r You can set the original type that is selected right after the machine is turned on or modes are cleared, with **[Original Type Priority]** under Gen. Settings/Adjust. See p.142 “General Settings/Adjustment”, *Facsimile Reference <Advanced Features>* .

- r You can have the machine return to the original type default setting after every transmission, with **[Scan End Reset]** under Gen. Settings/Adjust. See p.142 “General Settings/Adjustment”, *Facsimile Reference <Advanced Features>* .

1 Press **[Original Type]**.



2 Select the original type you require, and then press **[OK]**.



Image Density (Contrast)

The text and diagrams on originals should stand out clearly from the paper they are on. If your original has a darker background than normal (for example, a newspaper clipping), or if the writing is faint, adjust the image density.

v **Auto Image Density**

The appropriate density setting for the original is automatically selected.

v **Manual Image Density**

Use manual image density to set image density yourself.

You can select one of seven image density levels.

v **Combined Auto and Manual Image Density**

You can only adjust image density for photographs, illustrations, or diagrams if the original has a dark background.

You can select one of seven image density levels.

Note

- r Selecting **[Text]** or **[Text/Photo]** for the original type causes **[Auto Image Density]** to be selected.
- r You can set the image density that is selected right after the machine is turned on or modes are cleared, with **[Auto Image Density]** under **[Gen. Settings/Adjust]**. See p.142 “General Settings/Adjustment”, *Facsimile Reference <Advanced Features>* .
- r You can have the machine return to the image density default setting after every transmission, with **[Scan End Reset]** under **[Gen. Settings/Adjust]**. See p.142 “General Settings/Adjustment”, *Facsimile Reference <Advanced Features>* .

1 Select the type of image density.

Auto Image Density

A Make sure that [Auto Image Density] is selected.



Note

r If [Auto Image Density] has not been selected, press [Auto Image Density].

Manual Image Density

A Make sure that [Auto Image Density] is not selected. If it has been selected, press [Auto Image Density] to turn it off.

Note

r If [Auto Image Density] has not been selected, proceed to step B.

B Press [Lighter] or [Darker] to adjust the density.



Combined Auto and Manual Image Density

A Make sure that [Auto Image Density] is selected.

Note

r If [Auto Image Density] has not been selected, press [Auto Image Density].

B Press [Lighter] or [Darker] to adjust the density.

The square moves.



Mixing Scan Settings for a Multiple Page Original

When sending an original of several pages, you can select a different image density, resolution, and original type setting for each page.

Place the original, select the scan settings for the first page, dial, and then press the [Start] key as you would normally. Then follow one of the following two procedures.

Note

r It is recommended that originals be placed on the exposure glass when mixing scan settings for a multiple page original.

When placing originals on the exposure glass

Note

r While the machine is beeping, you have about 60 seconds (10 seconds for Immediate Transmission) to select density, resolution, and original type. The remaining time is shown on the display.

- 1** Check which pages you want to scan with different settings.
- 2** Remove the previous page and place the next page.
- 3** Select the image density, resolution, and original type.



Note

r Adjust the settings for each page before you press the **[Start]** key.

When placing originals in the optional Auto Document Feeder

Note

r Depending on what time the scan settings are adjusted, the settings may not be reflected in the resulting operation.

- 1** Check which pages you want to scan with different settings.

- 2** Select the image density, resolution, and original type before the next page is scanned.



Specifying a Destination

You can specify the destination using one of three methods.

- v **Fax number**
p.36 "Entering a Fax Number"
- v **E-mail address**
p.38 "Entering an E-mail Address"
- v **Destination list**
p.39 "Using Destination Lists"

This section covers these functions and others in more detail.

 **Note**

- r The display shows the percentage of free memory space for storing originals. Since fax numbers and e-mail addresses are programmed in separate memory, dialing fax numbers using the number keys does not change the percentage on the display.

Entering a Fax Number

Enter numbers directly using the key pad on the right side of the control panel.

 **Note**

- r Maximum length of a fax number: 128 digits.
- r You can insert pauses and tones in a fax number. See p.37 "Pause", p.37 "Tone".

1 Enter the fax number using the number keys.



 **Note**

- r If you make a mistake, press the **[Clear/Stop]** key, and then enter again.
- r If the optional extra G3 interface unit is installed, select G3 before you proceed to the next step. See p.59 "Changing the Line Port", *Facsimile Reference <Advanced Features>* .
- r Press **[ProgDest]** after entering the fax number to store the fax number in the destination list.

Pause

Press the **[Pause/Redial]** key when dialing or storing a number to insert a pause of about two seconds.

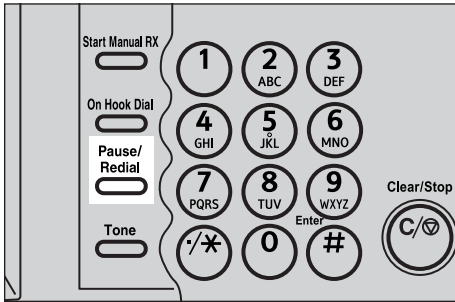

Note

- r You cannot insert a pause before the first digit of a fax number. If you press the **[Pause/Redial]** key at the first digit, a redial occurs. See p.47 "Redial", *Facsimile Reference <Advanced Features>*.
- r A pause is shown as a "--" on the display.



Note

- r You can also program numbers including pauses in destination lists.

Tone

This function allows a machine connected to a pulse dialing line to send tonal signals (for example if you want to use a special service on a tone dialing line). When you press the **[Tone]** key, the machine dials the number using tonal signals.

Limitation

- r Certain services may be unavailable when using the **[Tone]** key.

Note

- r A tone is shown as a "•" on the display.

Using the **[Tone]** key with On Hook Dial

- 1** Press the **[On Hook Dial]** key.

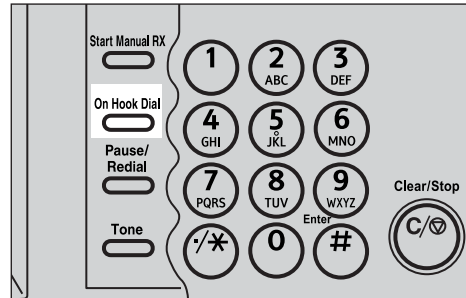

- 2** Enter the fax number using the number keys.

- 3** Press the **[Tone]** key.

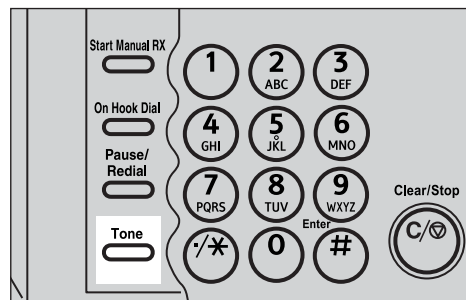

- 4 Enter the number you want to tone dial using the number keys.

Entering an E-mail Address

When using Internet Fax transmission, specify the e-mail address in place of the fax number.

Note

r You can enter up to 128 characters.

- 1 Make sure that  is displayed in the destination display column.



Note

r If it is not displayed, press .

- 2 Press [Manual Input].



- 3 Enter the e-mail address destination and then press [OK].



Note

- r If you enter an incorrect character, press [Backspace] or [Delete All]. Then, re-enter the characters correctly.
- r To change the e-mail address after pressing [OK], press [Edit Dest.], re-enter an e-mail address, and then press [OK].

Reference

“Entering Text”, *General Settings Guide*

The destination is specified.



Note

- r Press [ProgDest] in this order to store the entered e-mail address in the address book.

Using Destination Lists

When you program a destination number into a destination list, you can specify the destination by just selecting the Quick Dial key from the destination list.

The programmed name appears on Quick Dial key.

Pressing  switches the destination list between fax number destination and e-mail address destination.

If you frequently send the same message to more than one place, program these numbers and/or e-mail addresses into a Group. Then you can send messages to all the destinations in that Group with just a few keystrokes. You can also program a name for the Group (for example, "Branch Offices"), this will be displayed before you press the **[Start]** key.

Preparation

In the destination list, program individual fax number, e-mail address and/or groups of destinations. See "Registering a Fax Destination", "Registering an E-mail Destination", and "Registering a New Group", *General Settings Guide*.

Limitation

- r Group Dial can be used only for Memory Transmission; it cannot be used for Immediate Transmission. The machine automatically changes to Memory Transmission when you use Group Dial.

Note

- r When you press the title key above the destination keys, the destination keys programmed in that title key appear.
- r To check the contents of Quick Dial, print the destination list. See "Key Operator Tools", *General Settings Guide*.
- r A stored name can be printed out on the first page of a received fax at the other end. See p.74 "Label Insertion", *Facsimile Reference <Advanced Features>*.
- r To check the contents of the Groups, print the list. See "Key Operator Tools", *General Settings Guide*.
- r A total of 500 destinations (per message) can be programmed for Group Dial.

1 Place the original, and then select the scan settings you require.

2 Press  to switch the destination to fax number or e-mail address.

3 Press the title key where the desired destination is programmed.

For example, if you want to specify "NEW YORK OFFICE" programmed in "LMN", press **[LMN]**.



Note

- r There are three types of title for destination lists; "Title 1", "Title 2", and "Title 3". The above display shows "Title 1".

Switching the titles of destination lists

- A Press .
- B Press **[Switch Title]**.
- C Select the type of the title, and then press **[Exit]**.

4 Select a destination.



 **Note**

- r Press  to switch the destination between fax number and e-mail address.

Specifying a single destination

- A Press the Quick Dial key programmed with the desired destination.

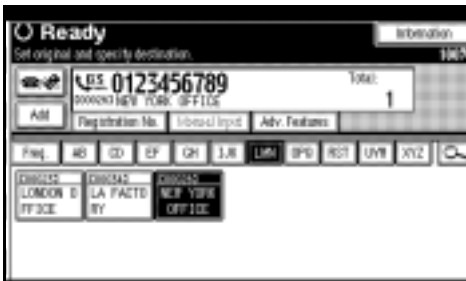

 **Note**

- r If the desired Quick Dial key is not shown, press **[▲]** and **[▼]** to scroll through the list.

- r To cancel the selection, press the selected Quick Dial key again. You can also press the **[Clear / Stop]** key to cancel the selection.
- r To select more destinations, repeat steps **3** and **4**.

Specifying a group of destinations

- A Press the Quick Dial key programmed with the desired group.



 **Note**

- r If the desired Quick Dial key is not shown, press **[▲]** and **[▼]** to look through the list.
- r To cancel the selection, press the selected Quick Dial key again. You can also press the **[Clear / Stop]** key to cancel the selection.
- r To cancel any destination(s) among the group, press **[▲P-prev.]** and **[▼Next]** to display the desired destination. Then, press the **[Clear/Stop]** key.
- r Quick Dial keys with fax numbers and e-mail addresses programmed in them appear in both fax destination and Internet Fax destination.

- r When a destination where neither fax number nor e-mail address are programmed is included in the specified group, the “The specified group contains some invalid destination(s). Do you want to select only valid destination(s)?” message appears. Press **[Select]** to specify destinations where the fax number or the e-mail address is programmed. Press **[Cancel]** to change the destination.
- r To select more groups, repeat steps **3** and **4**.

5 Press the **[Start]** key.

Searching for a Destination

Use this procedure to search through the destination lists for a particular destination.

2

- ✓ **Search by Destination Name**
p.42 "Search by Destination Name"
- ✓ **Search by Fax Number**
p.43 "Search by Fax Number"
- ✓ **Search by E-mail Address**
p.44 "Search by E-mail Address"
- ✓ **Specifying a Registration Number**
p.45 "Specifying a Registration Number"

Search by Destination Name

 **Note**

- r The search returns only destinations whose beginnings match the entered name.
- r This function distinguishes between small and capital letters.

1 Press  to switch the destination to fax number or e-mail address.

2 Press , the magnifier icon.

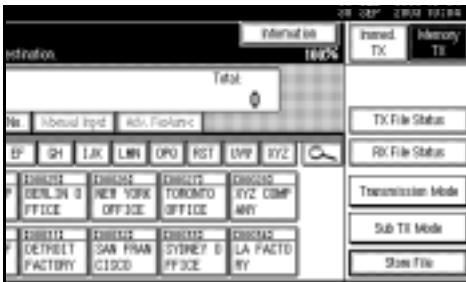

3 Press **[Search by Dest. Name]**.



4 Enter a destination name to search for, and then press **[OK]**.



A search-in-progress message appears.

When the search is finished, a result appears.

 **Note**

- r If you press **[Fax]** or **[E-mail]** on the search result display, you can switch between fax destination and e-mail destination.
- r A warning appears if the search returns more than 100 items. Press **[OK]** to proceed to step **5**.

5 Select a destination.



Note

- r If the desired destination does not appear, use [▲] or [▼] to scroll through the list.
- r If the search returns more than 100 destinations, only 100 will appear. Change the destination name to view fewer destinations.

3 Press [Search by Fax No.].



Note

- r If [Search by Fax No.] appears dimmed, press [Fax] on the right of the display, and then press [Search by Fax No.].

Search by Fax Number

Limitation

- r You can search by fax number only. To search by e-mail address, see p.44 "Search by E-mail Address".

Note

- r The search returns only destinations whose beginnings match the entered number.

1 Press to switch the destination to fax number.

2 Press , the magnifier icon.

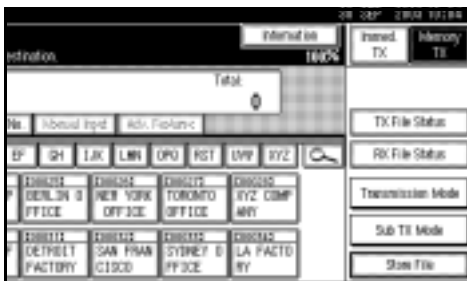

4 Enter a number to search for, and then press [OK].



Note

- r If you enter a wrong number, press [←] / [→] and [Clear], and then enter the number again.

A search-in-progress message appears.

When the search is finished, a result appears.

Note

- r A warning appears if the search returns more than 100 items. Press **[OK]** to proceed to step **5**.

5 Select a destination.



Note

- r If the desired destination does not appear, use **[▲]** or **[▼]** to scroll through the list.

Limitation

- r If the search returns more than 100 destinations, only 100 will appear. Change the number to view fewer destinations.

Search by E-mail Address

Limitation

- r You can search by e-mail address only. To search by fax number, see p.43 "Search by Fax Number" .

Note

- r The search returns only destinations whose beginnings match the entered e-mail address.

1 Press to switch the destination to e-mail address.

2 Press , the magnifier icon.

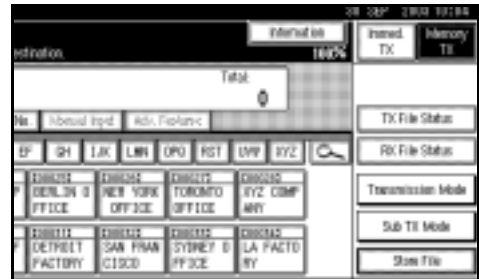

3 Press **[Search by E-mail]**.



Note

- r If **[Search by E-mail]** appears dimmed, press **[E-mail]** on the right of the display, and then press **[Search by E-mail]**.



4 Enter an e-mail address to search for, and then press **[OK]**.



Note

- r If you enter a wrong e-mail address, press **[←]** / **[→]** and **[Backspace]** / **[Delete All]**, and then enter the e-mail address again.

A search-in-progress message appears.

When the search is finished, a result appears.

Note

- r A warning appears if the search returns more than 100 items. Press **[OK]** to proceed to step **5**.

5 Select a destination.



Note

- r If the desired destination does not appear, use **[▲]** or **[▼]** to scroll through the list.

Limitation

- r If the search returns more than 100 destinations, only 100 will appear. Change the e-mail address to view fewer destinations.

Specifying a Registration Number

Use this procedure to select a destination by specifying a registration number.

1 Press  to switch the destination to fax number or e-mail address.

2 Press **[Registration No.]**.



The registration number entry display appears.

3 Enter a registration number using the number keys.



Note

You do not need to enter the first zeros of a registration number when the display prompts you to enter five digits. If you do not enter 5 digits, press the **[#]** key to complete the entry.

The corresponding destination appears.

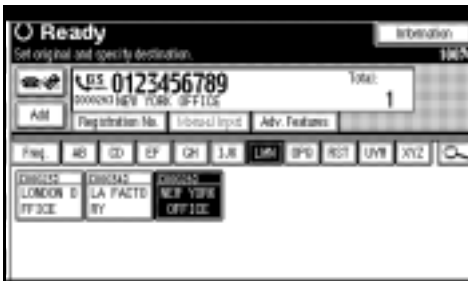

Note

Title word key is switched to the one that the specified destination is programmed in.

If the "Cannot find the specified Registration No." message appears, the specified registration number is wrong. Press **[Exit]**, check the registration number again, and then follow the procedure from step **1**. If the "No valid destination under the specified No." message appears, the  key is wrong. Press **[Exit]**, and then follow the procedure from step **1**.

2

Reception

There are two ways you can set up your machine to handle incoming calls:

- Manual Reception (external telephone required)
- Auto Reception

You can change the reception mode only if a standard G3 line is used.

You cannot change the reception mode when a line other than the standard G3 line (G3-2 or G3-3) is used.

v Manual Reception

When a telephone call comes in, the machine rings. If the call is a fax message, you must switch manually to facsimile mode.

v Auto Reception

When a telephone call comes in, the machine automatically receives it as a fax message. Use this setting on a dedicated fax line.

Note

- r The external telephone is required to use this machine as a telephone.

Switching the Reception Mode

You can switch reception modes using the Reception Settings menu (under Facsimile Features). See p.144 “Reception Settings”, *Facsimile Reference <Advanced Features>*.

If you program a Quick Operation key with Switch Reception Mode, you can switch reception mode quickly.

Note

- r You can only use this function after programming a Quick Operation key as the reception mode switch with **[Quick Operation key 1]**, **[Quick Operation key 2]**, or **[Quick Operation key 3]** under Gen. Settings/Adjust. See p.142 “General Settings/Adjustment”, *Facsimile Reference <Advanced Features>*.

1 Press the **[Switch RX Mode]** Quick Operation key.

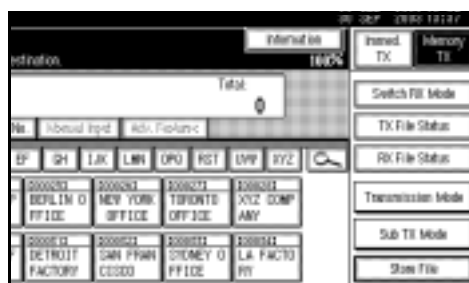

- 2 Select the reception mode, and then press [OK].



The standby display appears.

Note

- r To cancel the selection, press [Cancel].

Receiving a Fax in Manual Reception Mode

- 1 When the machine rings, pick up the handset of the external telephone.
- 2 If you hear beeps, press the [Start] key or the [Start Manual RX] key. (The [Start] key is only available in facsimile mode when an original is not placed.)
- 3 Replace the handset of the external telephone. The machine will start receiving.

Limitation

- r When printing documents stored in the Document Server, the [Start Manual RX] key or the [Start] key cannot be used to switch to facsimile mode. Press the [2] key of the external telephone.

3. Using Internet Fax Functions

Internet Fax Functions

The optional printer/scanner unit is required

This machine converts scanned document images to e-mail format and transmits the data over the Internet.

The e-mail sent by this machine can be received by another Internet Fax machine. Instead of dialing the telephone number of the destination you want to send to, you enter the relevant e-mail address.

You can also print or forward received e-mail messages.

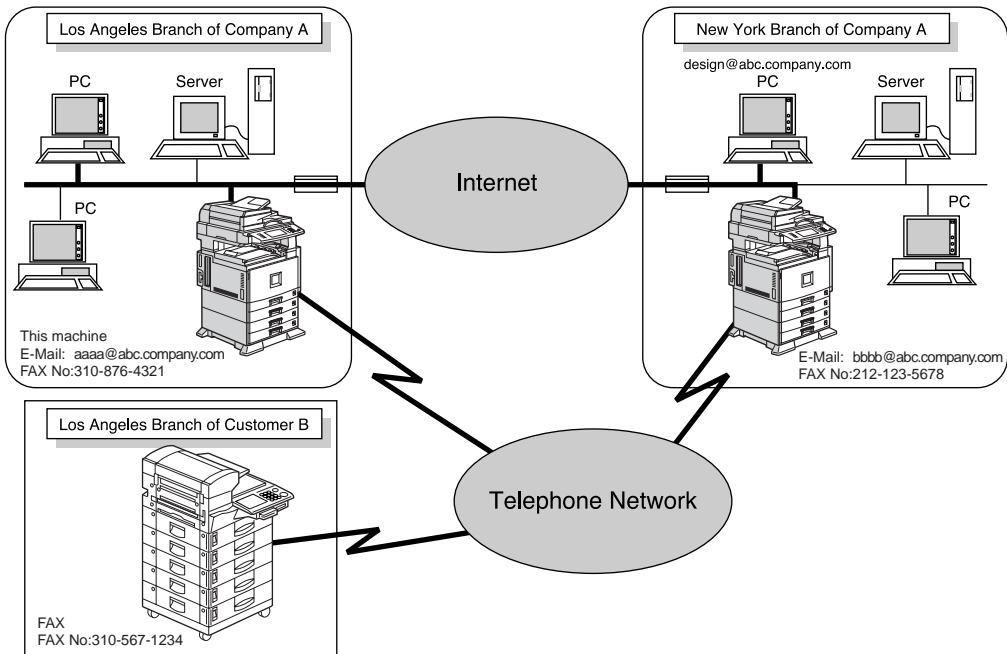

Note

- r This machine must be connected to a LAN and set up correctly in order to use its Internet Fax functions. See *Network Guide*.
- r The Internet Fax function supported by this machine is compliant with ITU-T Rec. T.37. See p.195 "Compatible Machines", *Facsimile Reference <Advanced Features>*.
- r You can receive e-mail messages with an attached TIFF-F image from computers.

Internet Fax Precautions

3

- Internet Fax communicates with a server over a LAN. It cannot communicate directly with other parties.
- If a transmission is not successful, this machine usually receives an e-mail error notification. See p.189 "Server-Generated Error E-mail", *Facsimile Reference <Advanced Features>* . However, e-mail error notifications may not be transmitted for various reasons. We recommend you confirm receipt of important document by calling the other party.
- The level of security for Internet communications is low. We recommend you use the telephone network for confidential communications.
- Voice communication is not supported over a LAN.
- Internet Fax delivery might be delayed due to network congestion. Use a standard fax whenever communication is time sensitive.
- If you use this machine with dial-up connection, the Auto E-mail Reception function accesses the provider's server via telephone line and may incur call charges even if you do not receive e-mail. To reduce the frequency of server access, specify a large E-mail Reception Interval. For the E-mail Reception Interval setting, see "Settings You Can Change with User Tools - File Transfer", *Network Guide*.

Functions Not Supported by E-mail Transmission

The following functions are supported with standard fax transmission, but not with Internet Faxing.

- Immediate Transmission
- Confidential Transmission
- ID Transmission
- Polling Transmission
- Chain Dial
- Transmission by SUB Code
- On Hook Dial
- Manual Dial
- JBIG Transmission
- Batch Transmission
- ECM (Error Correction Mode)
- Memory File Transfer

Functions Not Supported by E-mail Reception

The following functions are supported with standard fax reception, but not with Internet Faxing.

- Confidential Reception
- Memory Lock Reception
- Polling Reception
- SUB Code reception
- Authorized Reception
- Reception File Print Quantity

Transmitting Internet Fax

Preparation

You need to make System Settings beforehand. See "Setting Up the Machine on a Network", *Network Guide*.

This section describes how to scan a document into the memory and send it as e-mail. Specify the destination's e-mail address instead of fax number.

You can send Internet Fax in only Memory Transmission. If you specify Immediate Transmission in Internet Fax, the mode is switched to Memory Transmission when one e-mail address or more is specified.

When sending documents, you can set e-mail options using **[Sub TX Mode]**.

You can set the following options:

v Enter Subject

Allows you to enter a subject for the document you want to send.

Note

- r For convenience, program frequently-used subject. "Urgent", and "High" are programmed as default. See "Settings You Can Change with User Tools - File Transfer", *Network Guide*.
- r You can enter up to 64 characters in total.
- r If you send e-mail without setting a subject/text in "E-mail Options" under "Sub TX Mode", the subject is automatically inserted. For more details about how a subject is automatically inserted, see p.57 "About the E-mail Subject".
- r You cannot send a subject only as e-mail without an original.

v Enter Text

Allows you to enter the text to be transmitted.

Note

- r To enter text, program it beforehand. See "Settings You Can Change with User Tools - File Transfer", *Network Guide*.
- r You cannot send a text only without an original.

v Reception Notice

You can confirm sent documents were properly received using e-mail or Journal.

v BCC Transmission

E-mails are sent to all specified destinations as bcc.

Important

- r If power outage lasts about an hour, or the machine is disconnected from the power outlet for about an hour, documents stored in the fax machine's memory are deleted. If any document is deleted, the Power Failure Report is automatically printed out when the main power switch is turned on. Use this report to check which documents were deleted. Simply turning off the power by pressing the Operation switch does not delete stored documents. See p.187 "Power Failure Report", *Facsimile Reference <Advanced Features>*.
- r You may not be able to send large files as e-mail, depending on e-mail environment conditions.
- r The level of security for Internet communications is low. Use of the telephone network is recommended for confidential communications.

! Limitation

- r When available memory is low, you may not be able to send the Internet Faxes.

📝 Note

- r Because the machine sends documents as e-mail messages with an attached TIFF-F image, viewer applications are required in order to view documents when they are received on a computer.
- r You can limit the size of transmitted e-mail messages in “E-mail Settings” of “Fax Features”. See p.145 “E-mail Settings”, *Facsimile Reference <Advanced Features>* .
- r See p.62 “Received Images” for how e-mail is actually received by the computer when it is sent with mail options selected.
- r When you transmit an Internet Fax specifying a user code, and the e-mail address is set as the routing destination of the specified user code, a Communication Result Report is sent after the transmission is completed. This makes it possible to verify the result of a transmission.
- r You can specify fax destination and Internet Fax destination simultaneously.
- r You cannot send e-mails to a destination as cc.

1 When you set an e-mail option, press [Sub TX Mode].

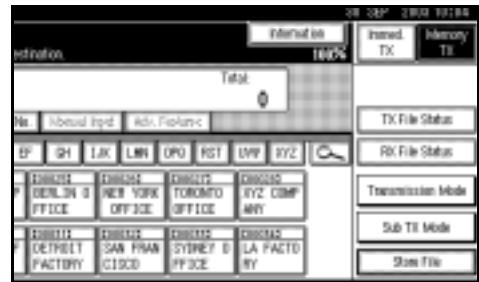

If you are not setting e-mail options, proceed to step 3.

2 Press [E-mail Options].

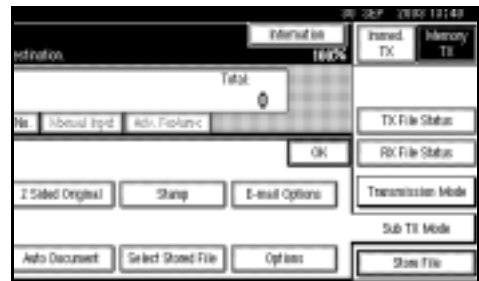

To enter the subject

A Press [Change] for Enter Subject.

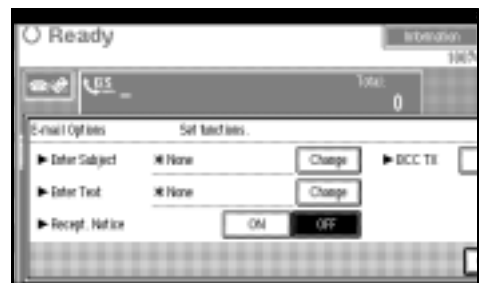

There are two methods of entering a subject: Selecting from programmed subjects, or entering characters directly. If you are entering characters, proceed to step C.

B Select the subject from the displayed list.



The selected subject appears in the manual input column.



Note

- r You can enter extra characters after the selected subject. If you do not need to enter extra characters, proceed to step E.

C Press [Manual Input].



D After entering the subject, press [OK].



Reference

“Entering Text”, *General Settings Guide*

Entered characters appear in the manual input column.



Note

- r You can add a programmed subject after the entered subject. Select the subject from the displayed subjects.

E Press [OK].



To enter the text

A Press **[Change]** for Enter Text.

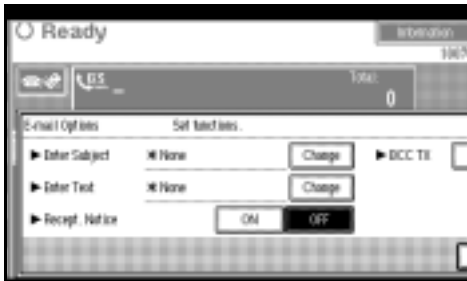

B Select a text, and then press **[OK]**.



To set reception notice

A Select **[ON]** or **[OFF]** for Recept. Notice.

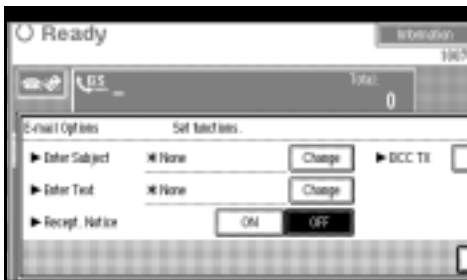

Reference

See p.58 "Confirming Reception".

To set BCC transmission

A Select **[Yes]** or **[No]** for BCC TX.

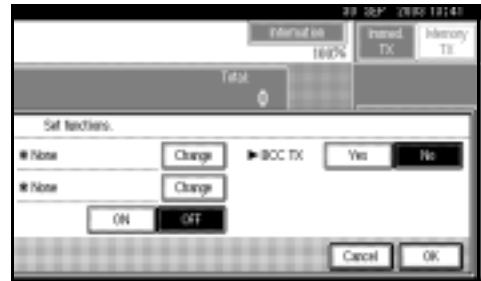

3 Press **[OK]**.

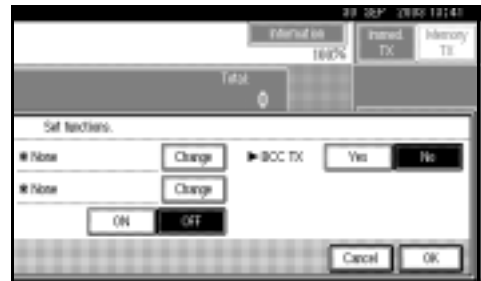

4 Press **[OK]**.

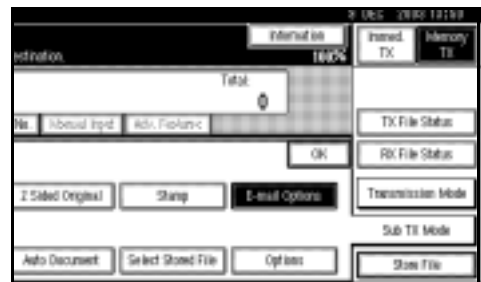

5 Place the original.

Note

- r You can send the first few pages from the exposure glass then the remaining pages from the ADF. After you remove the last page from the exposure glass, you have 60 seconds to insert the remaining pages in the ADF.
- r Note that you cannot place pages on the exposure glass after you have started using the ADF.

- r The original can be placed either in the ADF or on the exposure glass, until the **[Start]** key is pressed.

Reference

p.13 "Placing Originals"

6 Select the scan settings you require.



Note

- r In Internet Fax transmission, the original is scanned using "Detail" resolution for transmission, even if you select "Super Fine".
- r When using the Internet Fax function, documents transmitted are sent at A4 width. Documents larger than A4 are reduced to A4 width.

Reference

p.31 "Resolution"
 p.32 "Original Type"
 p.33 "Image Density (Contrast)"

7 Enter the e-mail address.



Note

- r If is not displayed in the destination display column, press .

Reference

p.38 "Entering an E-mail Address"
 p.39 "Using Destination Lists"
 p.47 "Redial", *Facsimile Reference* <Advanced Features>.

8 To send the same document to multiple destinations, press **[Add]**.



To send e-mail to one destination only, proceed to step 10.

Note

- r It is not necessary to press **[Add]** when adding destinations using the destination list.

9 Specify the next destination.



Note

- r Press to switch the destination between fax number and e-mail address.
- r To specify more destinations, repeat steps 8 and 9.

10 Press the **[Start]** key.

This starts reading the document into memory. The e-mail send operation starts after the read operation is complete. When scanning is complete, the Communicating indicator lights and transmission starts.

Note

- r With a large volume of document, it may take some time before transmission starts. This is due to the time the machine requires to convert the data in memory.
- r To cancel transmission of an Internet Fax, see p.59 "Canceling a Transmission of an Internet Fax".

About the E-mail Subject

If no subject is specified for "Enter Subject/Text" under "E-mail Options", a subject is automatically inserted. The subject is different according to the setting of Stamp Sender Name.

v When a name is set to Stamp Sender Name:

From "Stamp Sender Name" Fax Message NO.xxxx.

v When Stamp Sender Name is set to Do not Stamp:

- If Own Fax Number and Own Name are programmed:
From "Own Fax Number" ("Own Name") (Fax Message NO.xxxx)
- If only Own Fax Number is programmed:
From "Own Fax Number" (Fax Message NO.xxxx)

- If only Own Name is programmed:
From "Own Name" (Fax Message NO.xxxx)
- If neither Own Fax Number nor Own Name are programmed:
Fax Message NO.xxxx

Note

- r "xxxx" is the document number that appears in the Journal.

Reference

p.75 "Selecting transmission options for a single transmission", *Facsimile Reference <Advanced Features>*

E-mail Text

When Internet Fax e-mail is sent to computer, the following information is always inserted in the e-mail text. To check the host name and e-mail address, see "Settings You can Change with User Tools", *Network Guide*.

This e-mail was sent from "Host Name" (product name)

Queries to: "Administrator's e-mail address"

Confirming Reception

When Reception Notice is set under "E-mail Options", the receiver sends back a reception notice message. Once the reception notice message has been received, "OK" appears in the Result column of Journal, allowing the originator to verify that the transmission has been received.

Limitation

r The Reception Notice feature is only available if the receiver supports MDN (Message Disposition Notification).

Note

r If your fax is not received normally, "Error" appears in the Result column.

r Information regarding the last 200 messages is recorded, but only the last 50 communications appear in Journal. If you do not receive a reception notice message for one of the last 50 communications from the receiver's machine, you may not be able to confirm that the e-mail has been received by the Journal's Result column.

r If you specify mailing list addresses, do not set for Reception Notice. Otherwise, you will receive multiple reception notice messages from e-mail recipients, and the Result column will be overwritten each time a new notice message is received. However, if you receive a reception notice message indicating an error, "Error" appears in the Result column and will not be overwritten, even if you subsequently receive a reception notice message as "OK" following the error message.

r Reception notice results are only shown in Journal. The Result column in all other files, lists, and transmission reports show "-".

r Reception notice messages themselves are not recorded in Journal.

r The reception notice can be printed out. This can be set with User Parameters. See p.159 "User Parameters", *Facsimile Reference <Advanced Features>* (switch 21, bit 0).

r You cannot broadcast e-mails with the Reception Notice feature.

Canceling a Transmission of an Internet Fax

When fax and Internet Fax destinations are specified simultaneously, you can cancel sending using the same method.

Before the Original Is Scanned

Use this procedure to cancel a transmission before pressing the **[Start]** key.

- 1 Press the **[Clear Modes]** key.

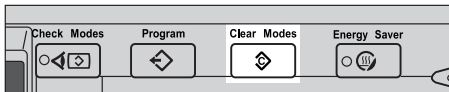

Note

- r When documents are placed in the ADF, you can cancel transmission simply by removing them.

While the Original Is Being Scanned In

Use this procedure to cancel a transmission after pressing the **[Start]** key.

- 1 Press the **[Clear/Stop]** key.

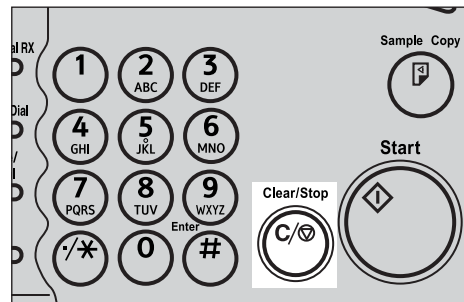

The machine stops scanning.

Note

- r You can also cancel scanning by pressing **[Stop Scanning]**.
- r Scanning may be completed while you are performing the cancel operation.
- r If the transmission finishes while you are carrying out this procedure, it will not be canceled.

After the Original Has Been Scanned In

Note

r You can not cancel the transmission of an Internet Fax being sent.

1 Press **[Change/Stop TX File]**.



The list of stored files being transmitted or waiting for transmission appears.

2 Select the file you want to cancel.

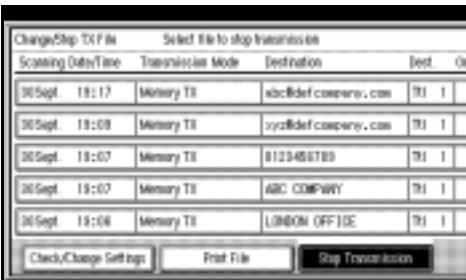

Note

r If the desired file is not shown, press **[▲ Prev.]** or **[▼ Next]** to find it.

3 Press **[Stop Transmission]**.



Note

r To cancel another file, repeat steps **2** and **3**.

r To save the scanned file, press **[Save]**.

4 Press **[Exit]**.



The standby display appears.

Receiving Internet Fax

You can receive e-mail documents by Internet Fax.

There are two methods of receiving e-mail: Auto E-mail Reception and Manual E-mail Reception.

Limitation

E-mail with attachments other than TIFF-F format files cannot be received. Senders receive an Error Mail Notification if their e-mail contains attachments. You can select whether or not the machine sends this message with User Parameters. See p.159 "User Parameters", *Facsimile Reference <Advanced Features>* (switch 21, bit 7). However, TIFF-F documents created by the Saving function of Desktop-Binder V2 Professional Lite can be received.

Note

- r When Reception Protocol is set to POP3 or IMAP4, you can set the machine to retain incoming e-mail or delete it from the server in "System Settings". See "Settings You Can Change with User Tools - File Transfer", *Network Guide*.
- r With User Parameters, you can have the machine return the acknowledgment of e-mail to the sender. See p.159 "User Parameters", *Facsimile Reference <Advanced Features>* (switch 21, bit 1).

Auto E-mail Reception

When this function is turned on, the machine periodically checks the e-mail server for incoming e-mail and downloads it as necessary.

E-mail auto-reception should be set in "System Settings". When you select auto-reception, set the reception interval in minutes.

See "Settings You Can Change with User Tools - File Transfer", *Network Guide*.

Note

- r If memory runs out, e-mail will not be received at the specified intervals. Reception will resume when sufficient memory becomes available.

Manual E-mail Reception

The following operation allows you to receive e-mail at all times.

Preparation

Program the Manual E-mail RX function to a Quick Operation key beforehand. See p.142 "General Settings/Adjustment", *Facsimile Reference <Advanced Features>*.

1 Press [Manual E-mail RX].

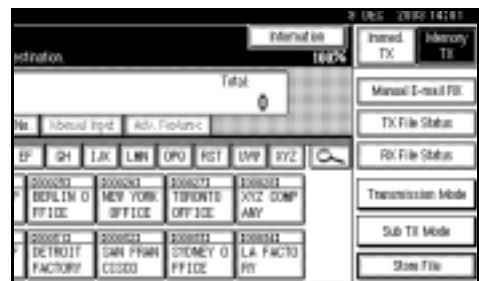

Access the server to check for e-mail. Receive any saved e-mails.

2 Check the message, and then press [Exit].



3

The standby display appears.

Received Images

Here is an example of an Internet Fax message sent from this machine and received on a computer using Outlook e-mail software.

The received image varies according to e-mail software.

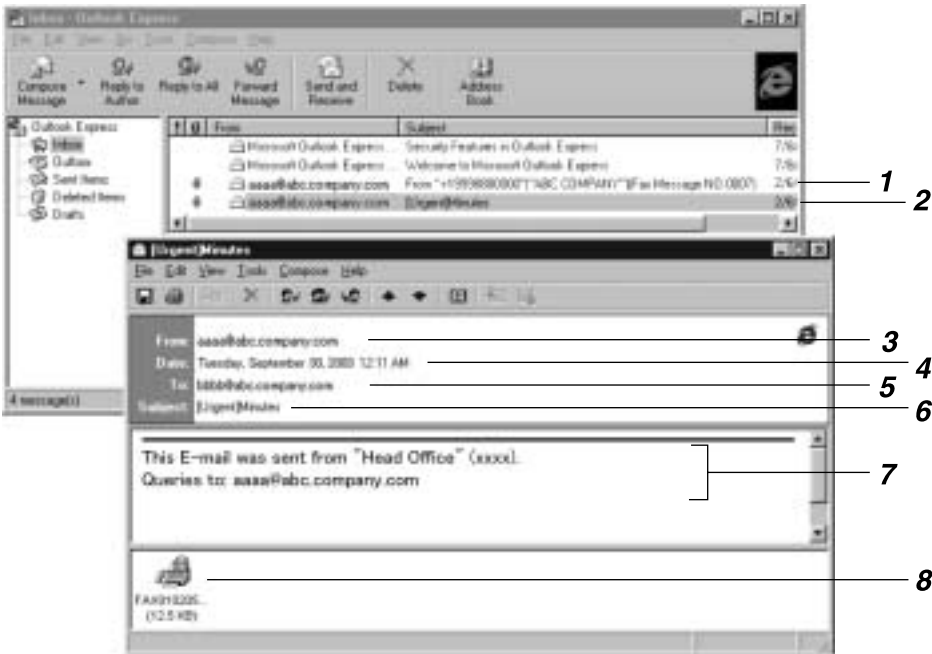

1. E-mail transmitted without specifying a subject in "E-mail Options".

2. E-mail transmitted with a subject specified in "E-mail Options".

3. From

The name (e-mail address) of the sender

Note

r The display format of the sender name differs according to that of the Stamp Sender Name setting and other functions.

4. Date

The date and time of e-mail transmission

5. To

The e-mail address of the recipient

6. Subject

Shows the subject specified in "E-mail Options" at the time of transmission. If no subject is specified, one is automatically assigned in the format shown in 1 above.

From "Own Fax Number" ("Own Name")
(Fax Message NO. document number)

Note

r The format varies according to Stamp Sender Name and other settings. See p.57 "About the E-mail Subject".

7. The message is inserted in all e-mails.

"xxxx" is the product name.

8. Attachment File

Any message included by the sender is displayed as an attached document.

4. Programming

Initial Settings and Adjustments

You can send information to the other party when transmitting or receiving a fax message. This information is shown on the display of the other machine and printed as a report. The following information can be sent.

Important

r You can confirm programmed settings from the User Parameter List. We recommend that you print and keep the User Parameter List when you program or change settings. See p.162 "Printing the User Parameter List", *Facsimile Reference <Advanced Features>* .

v Fax Header

The Fax Header is printed as the header of every fax you send. You should include your name in the Fax Header.

You can program Fax Header1 or Fax Header2. When you send originals using Quick Dial, you can select which Fax Header will be printed on the message received by the other party.

Note

r You can register up to 32 characters in the Fax Header.

r You can use characters, symbols, numbers, and spaces.

r You can set whether or not to print a Fax Header using [**Fax Header Print**] under [**Options**] . See p.73 "Fax Header Print", *Facsimile Reference <Advanced Features>* .

r In program No. 1 you can register a preference about whether or not the Fax Header is always printed. You will then switch the setting using the Fax Header Print function only when necessary. See p.126 "Registering a priority function using a program", *Facsimile Reference <Advanced Features>* .

Reference

p.73 "Fax Header Print", *Facsimile Reference <Advanced Features>*

p.126 "Registering a priority function using a program", *Facsimile Reference <Advanced Features>*

v Own Name

The Own Name is sent to the other party when you send or receive a fax using a G3 line. This name should include your name. The Own Name is shown on the display of the other machine and printed in a report.

Limitation

r Own Name works only when the other machine is of the same manufacturer, and has the Own Name function.

Note

r You can use characters, symbols, numbers, and spaces.

r You can register up to 20 characters as an Own Name.

4 **v Own Fax Number (facsimile number of sender)**

The sender's Own Fax Number is sent to the other party when sending a fax using a G3 line. The received facsimile number is shown on the display of the other machine and printed in a report. This function is available regardless of the manufacturer of the other party's machine.

 **Note**

r You can register up to 20 characters in Own Fax Number.

 **Note**

- r When the Key Operator Code is programmed and turned on, user have to enter programmed the Key Operator Code (maximum 8 digit) to operate Key Operator Tools.
- r This prevents unauthorized people from changing program.

Programming

1 Press the [User Tools/Counter] key.

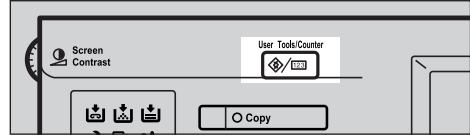

2 Press [Facsimile Features].



 **Note**

r If the key operator code is programmed and turned on, enter the key operator code and press the [OK] key.

3 Press [Program Fax Information].



4 Program the name and facsimile number.

Programming a Fax Header

A Press [First Name] or [Second Name].



B Enter a fax header, and then press [OK].



Reference
 “Entering Text”, *General Settings Guide*

Programming an Own Name

A Press [Own Name].



B Press [Own Name].



C Enter an own name, and then press [OK].



Reference
 “Entering Text”, *General Settings Guide*

Programming an Own Fax Number

A Press [Own Fax Number].



B Select line type to program.



Note

The display differs depending on the optional units installed on your machine.

C Enter your own facsimile's number using the number keys, and then press [OK].



Note

- To enter a + sign or a space, press [+] or [Space].
- If you make a mistake, press [Clear] or the [Clear / Stop] key, and then enter the facsimile number again.

5 Press [Exit].

6 Press the [User Tools/Counter] key. The standby display appears.

Editing

Note

The following procedure explains how to edit Own Name, as an example of editing.

1 Press the [User Tools/Counter] key.

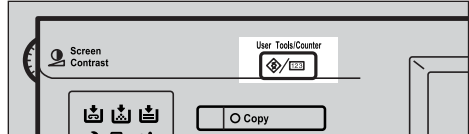

2 Press [Facsimile Features].



3 Press [Program Fax Information].

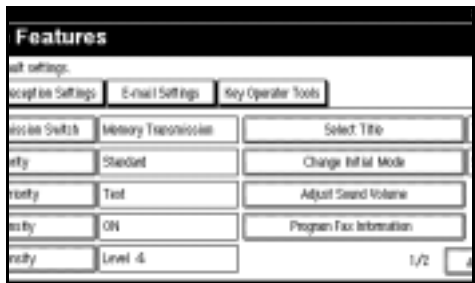

4 Press [Fax Header], [Own Name], or [Own Fax Number] for editing.



- 5** Press the item you want to edit.



- 6** Press [Backspace] or [Delete All], and then re-enter the name or number.



Note

- Press [Clear] or the [Clear/Stop] key if you want to edit Own Fax Number.

- 7** Press [OK].



- 8** Press [Exit].



- 9** Press the [User Tools/Counter] key. The standby display appears.

Deleting

Note

- The following procedure explains how to delete Own Name, as an example of deleting.

- 1** Press the [User Tools/Counter] key.

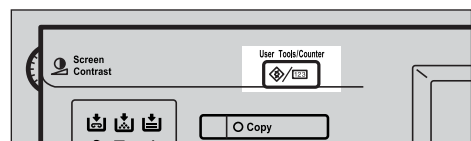

- 2** Press [Facsimile Features].



- 3** Press [Program Fax Information].

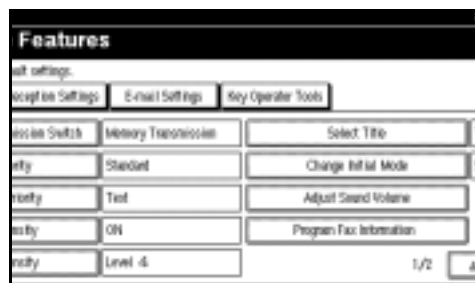

4 Press **[Fax Header]**, **[Own Name]**, or **[Own Fax Number]** to delete.



5 Press the item you want to delete.



6 Press **[Backspace]** or **[Delete All]**, and then press **[OK]**.



Note

Press **[Clear]** or the **[Clear/Stop]** key if you want to edit Own Fax Number.

7 Press **[Exit]**.



8 Press the **[User Tools/Counter]** key. The standby display appears.

Programming Fax Numbers and E-mail addresses

You can program fax destinations using Address Book Management in the Key Operator Tools menu under System Settings.

You can also register the programmed fax numbers and e-mail addresses in a Group.

Note

- r When you press the **[Facsimile]** key after changing the contents of the Address Book, such a message appears that indicates that the destination list has been updated. Press **[Exit]**. The standby display appears.

Reference

“Key Operator Tools”, *General Settings Guide*

“E-mail Destination”, *General Settings Guide*

“Registering Destinations to a Group”, *General Settings Guide*

5. Troubleshooting

Adjusting the Volume

You can change the volume of the following sounds that the machine makes.

- ✓ **On Hook Mode**
Heard when the **[On Hook Dial]** key is pressed.
- ✓ **At Transmission**
Heard when the machine sends a message.
- ✓ **At Reception**
Heard when the machine receives a message.
- ✓ **At Dialing**
Heard after pressing the **[Start]** key, until the line connects to the destination.
- ✓ **At Printing**
Heard when a received message is printed. See p.96 “Print Completion Beep”, *Facsimile Reference <Advanced Features>* .

Note

- r You can adjust the On Hook volume when you press the **[On Hook Dial]** key. See p.56 “On Hook Dial”, *Facsimile Reference <Advanced Features>* .

- 1** Press the **[User Tools/Counter]** key.

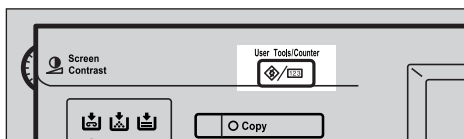

- 2** Press **[Facsimile Features]**.



- 3** Press **[Adjust Sound Volume]**.



- 4** Press **[Lower]** or **[Louder]** for each item, and then press **[OK]**.

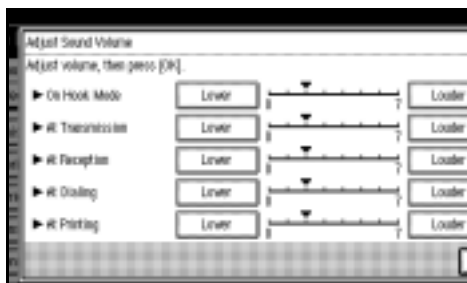

Note

- r You can hear the actual volume by pressing **[Check]**.
- r If you press **[Cancel]**, the volume setting is canceled. The display returns to that of step **3**.

- 5** Press the **[User Tools/Counter]** key.
The standby display appears.

When the [Facsimile] Key Is Lit in Red

If this key is lit, press the key to enter the facsimile mode. Then, refer to the table below and take the appropriate action.

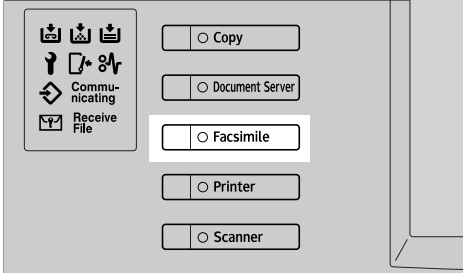

5

Problem	Solutions
The paper output tray is full.	Remove the paper from the tray.
A facsimile error has occurred.	The facsimile has a problem. Contact your service representative. See p.76 "Error Messages and Their Meanings" The copier will still function normally.
Out of paper	Add more paper. "Loading Paper", <i>General Settings Guide</i>
A network error has occurred.	<ul style="list-style-type: none"> • Check the displayed message. See p.76 "Error Messages and Their Meanings". • Check the machine is correctly connected to the network, and the machine is correctly set. See <i>Network Guide</i>. • Consult your network administrator. • When the key is still lit in red even if you take the measures above, please contact your service representative.

When Toner Runs Out

When the machine has run out of toner, the symbol appears on the display. Note that even if there is no toner left, you can still send fax messages.

Important

- r The number of communications, that have been executed after the toner has run out and that automatically-output Journal has not list, exceeds 200 (1000 with the optional expansion memory installed), communication will not be possible.

Limitation

- r The Memory Storage Report, Polling Reserve Report, and Confidential File Report are not printed.

- 1** Make sure that the machine is in facsimile mode.

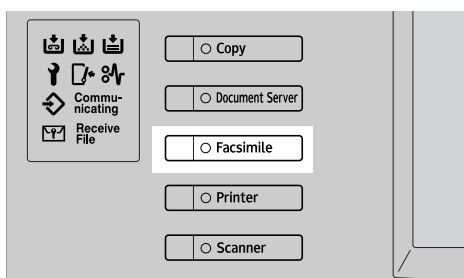

Note

- r If the standby screen is not displayed, press the **[Facsimile]** key.

- 2** Press **[Exit]**, and then perform transmission operation.



The error message disappears.

Reference

- p.20 "Memory Transmission"
- p.27 "Immediate Transmission"

Error Messages and Their Meanings

If there is an error, one of the following messages may appear on the display. If other message appears, follow the message.

Message	Causes and solutions
Put original back, check it and press [Start].	Original jammed during Memory Transmission. Place originals that have not been scanned again.
Error occurred, and transmission was canceled.	A document jam occurred during Immediate Transmission. Press [OK] , and then resend the pages that have not been sent.
	<p>An error occurred during Immediate Transmission. Press [OK], and then resend the original.</p> <p> Note</p> <p>There may be a problem with the machine or the telephone line (for example noise or cross talk). If the error reoccurs frequently, contact your service representative.</p>
Cannot detect original size. Place original again, then press [Start].	The machine failed to detect the size of the original. Place originals again, and then press the [Start] key.
<p> Call Service</p> <p>Functional problems with facsimile. Please call service.</p>	There is a problem with the fax. Record the code number shown in the display and contact your service representative. The copy function will still work normally.
Memory is full. Cannot scan more. Transmitting only scanned pages.	If you press [OK] , the machine returns to standby mode and starts transmitting the pages that have been stored.
Following output tray is full. Remove paper.	The paper output tray is full. Remove paper from the tray indicated in the display.
Cannot scan to send fax message as scanner is in use for other function.	<p>The Copy or Document Server function is in use. To cancel the job in process, do the following, and then try faxing again.</p> <p>Press [Exit], and then press the [Copy] or [Document Server] key. Next press the [Clear/Stop] key. When the message "[Stop] key was pressed. Stop copying?" or "[Stop] key was pressed. Stop storing?" appears, press [Stop].</p>
Updating the destination list. Please wait. Selected destinations or function settings have been cleared. Please reselect after the update finishes.	Wait with the main power switch on. The machine will enter standby mode after it exits from RDS mode.

Message	Causes and solutions
<p>Check whether there are any network problems. [14-01]</p>	<p>Cannot find the DNS server or SMTP server.</p> <ul style="list-style-type: none"> • Check the DNS server's IP address is correctly programmed using the Web browser. See the Web browser's Help. • Check the DNS server is correctly programmed using the Web browser. See the Web browser's Help. • Check the host name or IP address of the SMTP server is correctly programmed using the Web browser. See the Web browser's Help. • Check the SMTP server is correctly programmed using the Web browser. See the Web browser's Help. • Check the LAN cable is correctly connected to the machine. See "Connecting the Network Cable to the Network", <i>Network Guide</i>. • Consult your network administrator.
<p>Check whether there are any network problems. [14-09]</p>	<p>E-mail transmission was refused by SMTP authentication or POP before SMTP authentication.</p> <ul style="list-style-type: none"> • Check the user name and password for SMTP authentication or POP before SMTP authentication are correctly programmed from File Transfer under System Settings. See "Settings You Can Change with User Tools - File Transfer", <i>Network Guide</i>. • Check the user name and password of the e-mail account are correctly programmed from File Transfer under System Settings. See "Settings You Can Change with User Tools - File Transfer", <i>Network Guide</i>. • Consult your network administrator.
<p>Check whether there are any network problems. [14-33]</p>	<p>No machine's e-mail address is programmed.</p> <ul style="list-style-type: none"> • Check the machine's e-mail address is correctly programmed from File Transfer under System Settings. See "Settings You Can Change with User Tools - File Transfer", <i>Network Guide</i>. • Consult your network administrator.
<p>Check whether there are any network problems. [15-01]</p>	<p>No POP3/IMAP4 server's address is programmed.</p> <ul style="list-style-type: none"> • Check the host name or IP address of the POP3/IMAP4 server is correctly programmed using the Web browser. See the Web browser's Help. • Consult your network administrator.

Message	Causes and solutions
<p>Check whether there are any network problems. [15-02]</p>	<p>Cannot log on to the POP3/IMAP4 server.</p> <ul style="list-style-type: none"> • Check the user name and password of the machine are correctly programmed from File Transfer under System Settings. See "Settings You Can Change with User Tools - File Transfer", <i>Network Guide</i>. • Consult your network administrator.
<p>Check whether there are any network problems. [15-03]</p>	<p>No machine's e-mail address is programmed.</p> <ul style="list-style-type: none"> • Check the machine's e-mail address is correctly programmed from File Transfer under System Settings. See "Settings You Can Change with User Tools - File Transfer", <i>Network Guide</i>. • Consult your network administrator.
<p>Check whether there are any network problems. [15-11]</p>	<p>Cannot find the DNS server or POP3/IMAP4 server.</p> <ul style="list-style-type: none"> • Check the DNS server's IP address is correctly programmed using the Web browser. See the Web browser's Help. • Check the DNS server is correctly programmed using the Web browser. See the Web browser's Help. • Check the host name or IP address of the POP3/IMAP4 server is correctly programmed using the Web browser. See the Web browser's Help. • Check the POP3/IMAP4 server is correctly programmed using the Web browser. See the Web browser's Help. • Consult your network administrator.
<p>Check whether there are any network problems. [15-12]</p>	<p>Cannot log on to the POP3/IMAP4 server.</p> <ul style="list-style-type: none"> • Check the user name and password of the e-mail account are correctly programmed from File Transfer under System Settings. See "Settings You Can Change with User Tools - File Transfer", <i>Network Guide</i>. • Check the user name and password for POP before SMTP authentication are correctly programmed from File Transfer under System Settings. See "Settings You Can Change with User Tools - File Transfer", <i>Network Guide</i>. • Consult your network administrator.

 **Out of paper display message**

If the paper tray runs out of paper, "No paper. Load it, then press [Exit]." appears on the display, asking you to add more paper.

 **Note**

- r If there is paper left in the other paper trays, you can receive messages as usual, even if the message appears on the display.
- r You can turn this function on or off with the User Parameters. See p.159 "User Parameters", *Facsimile Reference <Advanced Features>* (switch 05, bit 7).

 **Network error display message**



If the "Check whether there are any network problems." message appears, the machine is not correctly connected to the network or the settings of the machine is not correct. If you do not need to connect the machine to the network, you can select so that the message disappear and the key goes out with User Parameters. See p.159 "User Parameters", *Facsimile Reference <Advanced Features>* (switch 21, bit 6).

 **Note**

- r When you restart connecting the machine to the network, make sure to set "Display" with User Parameters. Otherwise, you cannot check the status of the network connection.

Solving Problems

This table lists some common problems and their solutions.

Problem	Causes and solutions	Reference
Image background appears dirty when received at the other end. Images from the back page appear.	Adjust scan density.	p.33 "Image Density (Contrast)"
Printed or sent image contains spots.	The ADF or exposure glass is dirty. Clean them. Make sure that ink or correction fluid is dry before placing originals.	"Maintaining Your Machine", <i>General Settings Guide</i>
Received image is too light.	Request the sender to increase image density.	---
	When using moist, rough, or processed paper, the printed image may be partly invisible. Only use recommended paper.	"Copy Paper", <i>General Settings Guide</i>
	When  appears on the display, toner is beginning to run out. Replace the toner cartridge soon.	"  Adding Toner", <i>General Settings Guide</i>
The machine failed to print received fax messages.	If this happened when the receive file indicator was lit, a problem such as run out of paper or toner might disable printing.	p.86 "Substitute Reception", <i>Facsimile Reference <Advanced Features></i>
	[Store] has been selected for [Reception File Setting] . Print the fax messages using a Web browser or the Print Stored RX File function.	p.122 "Printing fax information using a Web browser", <i>Facsimile Reference <Advanced Features></i> and p.34 "Printing Received and Stored Documents", <i>Facsimile Reference <Advanced Features></i>
	When  is lit, load paper into the tray.	"Loading Paper", <i>General Settings Guide</i>
Message appears blank at the other end.	The original was placed upside down. Place it properly.	p.13 "Placing Originals"
Both transmission and receiving are impossible.	Make sure that the modular cord is correctly connected.	p.192 "Connecting the Machine to a Telephone Line and Telephone", <i>Facsimile Reference <Advanced Features></i>
	The terminal adaptor setting is incorrect. Check the setting.	---

Problem	Causes and solutions	Reference
Transmission is possible, though receiving is impossible.	The optional terminal adaptor setting is incorrect. Check the setting.	---
Receiving is possible, though transmission is impossible.	The optional terminal adaptor setting is incorrect. Check the setting.	---
When using On Hook Dial or Manual Dial, "Receiving" appears and transmission is not allowed.	If the machine fails to detect the size of the original when the [Start] key is pressed, it performs a receiving operation. Press [Scan Area] , select the scan area, and then resend the document.	p.16 "Setting a Scan Area"
All fax messages stored in memory have been lost. Those messages include ones stored through Memory Transmission/Reception, Confidential Reception, Substitute Reception, or Auto Document.	When about one hour passes after power of the machine is turned off, all fax messages stored in memory are lost. If any messages have been lost for this reason, a Power Failure Report is automatically printed when the machine is turned on. If fax messages stored for Memory Transmission have been lost, check the destinations and resend the messages. If fax messages received through Memory, Confidential or Substitute Reception have been lost, ask the senders to resend the messages. If Auto Documents have been lost, reprogram them.	p.187 "Power Failure Report", <i>Facsimile Reference <Advanced Features></i>
Transmission failed due to "Exceeded max. E-mail size" error.	If the e-mail size specified on the machine exceeds, an Internet Fax document cannot be sent. Set Max. E-mail Size to OFF, or specify the maximum e-mail size to a larger volume. Then, resend the document.	p.145 "E-mail Settings", <i>Facsimile Reference <Advanced Features></i>
When a correct password is entered, you cannot print documents that appear in the confidential box or bulletin board box, or transmit / print out stored documents.	Documents are locked by a security function when incorrect passwords are entered a certain number of times. Contact the administrator.	"Extended Security Function", <i>General Settings Guide</i>

When Things Don't Go as Expected

I Want...	Operation	Reference
to cancel a Memory Transmission.	If the original is being scanned, press [Stop Scanning] or the [Clear/Stop] key.	p.24 "Canceling a Memory Transmission"
	If the original is being sent or if it is in standby, press [Change/Stop TX File] or the [Clear/Stop] key.	p.24 "Canceling a Memory Transmission" p.19 "Canceling a Transmission", <i>Facsimile Reference <Advanced Features></i>
to cancel an Immediate Transmission.	Press [Stop Transmission] or the [Clear/Stop] key.	p.30 "Canceling an Immediate Transmission"

INDEX

A

- Adjusting The Volume, 73
 - At Dialing, 73*
 - At Printing, 73*
 - At Reception, 73*
 - At Transmission, 73*
 - On Hook Mode, 73*
- Authorized Reception, 51
- Auto E-mail Reception, 61
- Auto Reception, 47

B

- Batch Transmission, 50
- BCC Transmission, 52
- Broadcasting, 20
- Broadcasting Sequence, 23

C

- Chain Dial, 50
- Check Modes key, 3
- Clear Modes key, 3
- Clear/Stop key, 5
- Communicating indicator, 4
- Confidential file indicator, 4
- Confidential Reception, 51
- Confidential Transmission, 50
- Control Panel, 3
- CSI->Own Fax Number, 66

D

- Destination list, 36, 39
- Detail, 31
- Display, 5
- Display Panel, 3

E

- ECM, 50
- Entering a fax number, 36
- Entering an e-mail address, 38
- Enter Text, in e-mail, 52
- Error Messages, 76

F

- Facsimile key, 4, 74
- Fax Header, 65
 - Deleting, 69*
 - Editing, 68*
 - Programming, 66*
- Faxing, 11
- Functions Not Supported by e-mail
 - Reception, 51
- Functions Not Supported by e-mail
 - Transmission, 50

G

- Getting Started, 3
- Groups
 - Using Destination Lists, 39*

I

- ID Transmission, 50
- Image Density (Contrast), 31, 33
- Immediate Transmission, 11, 12, 27, 50
 - Canceling, 30*
- Internet Fax, 49
- Internet Fax Precautions, 50
- Internet Fax, Transmitting, 52

J

- JBIG Transmission, 50

K

- # key (Enter key), 4

M

- Main Power indicator, 3
- Manual Dial, 50
- Manual Reception, 47
- Memory File Transfer, 50
- Memory Lock Reception, 51
- Memory Transmission, 11, 12, 20
 - Canceling, 24*

N

Number keys, 4

O

On Hook Dial, 50

On Hook Dial key, 4

On indicator, 4

Operation switch, 4

Original Type, 31, 32

Own Fax Number, 66

Deleting, 69

Editing, 68

Programming, 66

Own Name, 65

Deleting, 69

Editing, 68

Programming, 66

P

Pause, 37

Pause/Redial key, 4

Photo, 32

Placing Originals, 13

Polling Reception, 51

Polling Transmission, 50

Program key, 3

Programming, 65

Q

Quick Dial

Using a Destination Lists, 39

R

Received Images, 62

Receive File indicator, 4

Receiving Internet Fax, 61

Reception, 47

Auto Reception, 47

Manual Reception, 47

Reception File Print Quantity, 51

Reception Notice, 52, 58

Resolution, 31

RTI->Own Name, 65

S

Scan Settings, 31

Stamp Sender Name, 57

Standard, 31

Start key, 5

Start Manual RX key, 4

SUB Code reception, 51

Subject, in e-mail, 52, 57

Super Fine, 31

T

Text, 32

Text / Photo, 32

Tone, 37

Tone key, 4

Toner, 75

Transmission by SUB Code, 50

Transmission of an Internet Fax

Canceling, 59

TTI->Fax Header, 65

U

User Tools/Counter key, 3

MEMO



FAX Option Type 2045e

Operating Instructions Facsimile Reference <Advanced Features>



-
- 1 Transmission Mode
 - 2 Checking and Canceling Transmission Files
 - 3 Communication Information
 - 4 Other Transmission Features
 - 5 Reception Features
 - 6 LAN-Fax Features
 - 7 Simplifying the Operation
 - 8 Facsimile Features
 - 9 Key Operator Setting
 - 10 Solving Operation Problems
 - 11 Appendix

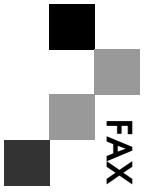

FAX Option Type 2045e Operating Instructions Facsimile Reference <Advanced>

Introduction

This manual describes detailed instructions on the operation and notes about the use of this machine. To get maximum versatility from this machine all operators are requested to read this manual carefully and follow the instructions. Please keep this manual in a handy place near the machine.

Notes

Some illustrations in this manual might be slightly different from the machine.

Certain options might not be available in some countries. For details, please contact your local dealer.

Two kinds of size notation are employed in this manual. With this machine refer to the metric version.

Important

Contents of this manual are subject to change without prior notice. In no event will the company be liable for direct, indirect, special, incidental, or consequential damages as a result of handling or operating the machine.

Trademarks

Microsoft®, Windows® and Windows NT® are registered trademarks of Microsoft Corporation in the United States and/or other countries.

Adobe® and Acrobat® are registered trademarks of Adobe Systems Incorporated.

Other product names used herein are for identification purposes only and might be trademarks of their respective companies. We disclaim any and all rights in those marks.

Note

The proper names of the Windows operating systems are as follows:

- The product name of Windows® 95 is Microsoft® Windows 95.
- The product name of Windows® 98 is Microsoft® Windows 98.
- The product name of Windows® Me is Microsoft® Windows Millennium Edition (Windows Me).
- The product names of Windows® 2000 are as follows:
Microsoft® Windows® 2000 Advanced Server
Microsoft® Windows® 2000 Server
Microsoft® Windows® 2000 Professional
- The product names of Windows® XP are as follows:
Microsoft® Windows® XP Professional
Microsoft® Windows® XP Home Edition
- The product names of Windows NT® 4.0 are as follows:
Microsoft® Windows NT® Server 4.0
- Microsoft® Windows NT® Workstation 4.0

Instructions for the optional extra G3 interface unit (G3 Interface Unit Type 2045) are included in the Basic Features and Advanced Features manuals.

Manuals for This Machine

The following manuals describe the operational procedures of this machine. For particular functions, see the relevant parts of the manual.

Note

- r Manuals provided are specific to machine type.
- r Adobe Acrobat Reader is necessary to view the manuals as a PDF file.
- r Two CD-ROMs are provided:
 - CD-ROM 1“Operating Instructions for Printer/Scanner”
 - CD-ROM 2“Scanner Driver & Document Management Utilities”

v **General Settings Guide**

Provides an overview of the machine and describes System Settings (paper trays, Key Operator Tools, etc.), Document Server functions, and troubleshooting.

Refer to this manual for Address Book procedures such as registering fax numbers, e-mail addresses, and user codes.

v **Network Guide (PDF file - CD-ROM1)**

Describes procedures for configuring the machine and computers in a network environment.

v **Copy Reference**

Describes operations, functions, and troubleshooting for the machine’s copier function.

v **Facsimile Reference <Basic Features>**

Describes operations, functions, and troubleshooting for the machine’s facsimile function.

v **Facsimile Reference<Advanced Features>(this manual)**

Describes advanced functions and settings for key operators.

v **Printer Reference 1**

Describes system settings and operations for the machine’s printer function.

v **Printer Reference 2 (PDF file - CD-ROM1)**

Describes operations, functions, and troubleshooting for the machine’s printer function.

v **Scanner Reference (PDF file - CD-ROM1)**

Describes operations, functions, and troubleshooting for the machine’s scanner function.

v **Manuals for DeskTopBinder V2 Lite**

DeskTopBinder V2 Lite is a utility included on the CD-ROM labeled “Scanner Driver & Document Management Utilities”.

- DeskTopBinder V2 Lite Setup Guide (PDF file - CD-ROM2)
Describes installation of, and the operating environment for DeskTopBinder V2 Lite in detail. This guide can be displayed from the **[Setup]** dialog box when DeskTopBinder V2 Lite is installed.
- DeskTopBinder V2 Lite Introduction Guide (PDF file - CD-ROM2)
Describes operations of DeskTopBinder V2 Lite and provides an overview of its functions. This guide is added to the **[Start]** menu when DeskTopBinder V2 Lite is installed.
- Auto Document Link Guide (PDF file - CD-ROM2)
Describes operations and functions of Auto Document Link installed with DeskTopBinder V2 Lite. This guide is added to the **[Start]** menu when DeskTopBinder V2 Lite is installed.

v **Manuals for ScanRouter V2 Lite**

ScanRouter V2 Lite is a utility included on the CD-ROM labeled “Scanner Driver & Document Management Utilities”.

- ScanRouter V2 Lite Setup Guide (PDF file - CD-ROM2)
Describes installation of, settings, and the operating environment for ScanRouter V2 Lite in detail. This guide can be displayed from the **[Setup]** dialog box when ScanRouter V2 Lite is installed.
- ScanRouter V2 Lite Management Guide (PDF file - CD-ROM2)
Describes delivery server management and operations, and provides an overview of ScanRouter V2 Lite functions. This guide is added to the **[Start]** menu when ScanRouter V2 Lite is installed.

v **Other manuals**

- PS3 Supplement (PDF file - CD-ROM1)
- Unix Supplement (Available from an authorized dealer, or as a PDF file on our Web site.)

Note

r The following software products are referred to using a general names:

- DeskTopBinder V2 Lite and DesktopBinder V2 Professional → DesktopBinder V2 Lite/Professional
- ScanRouter V2 Lite and ScanRouter V2 Professional (optional) → ScanRouter V2 Lite/Professional
- SmartNetMonitor for Admin and SmartNetMonitor for Client → SmartNetMonitor for Admin/Client

TABLE OF CONTENTS

Manuals for This Machine	i
How to Read This Manual	1
Symbols	1
 1. Transmission Mode	
<hr/>	
Sending at a Specific Time (Send Later)	3
User Transmission	5
Priority Transmission	7
Confidential Transmission	8
Polling Transmission	10
Polling Transmission Clear Report.....	12
Polling Reception	13
Polling Reserve Report	15
Polling Result Report	15
 2. Checking and Canceling Transmission Files	
<hr/>	
Displaying Confirmation of Transmission	18
Canceling a Transmission	19
Deleting a Destination	20
Adding a Destination	21
Changing the Transmission Time	22
Printing a File	23
Resending a File	24
Printing a List of Files in Memory (Print TX File List)	25
 3. Communication Information	
<hr/>	
Printing the Journal	27
Journal	29
Checking the Transmission Result (TX File Status)	31
Checking the Reception Result (RX File Status)	32
Displaying the Memory Status	33
Printing/Deleting Received and Stored Documents (Print Stored RX File)	34
Printing Received and Stored Documents	34
Deleting Received and Stored Documents	35
Printing a Confidential Message	36
Confidential File Report.....	37
Printing a File Received with Memory Lock	38
Personal Boxes	40
Personal Boxes	40
Printing Personal Box Messages	41

Information Boxes	42
Information Boxes	42
Storing Messages in Information Boxes.....	42
Printing Information Box Messages	44
Deleting Information Box Messages	45

4. Other Transmission Features

Handy Dialing Functions.....	47
Chain Dial.....	47
(Example) 01133-1-555333.....	47
Redial.....	47
Advanced Features.....	49
SUB Code	49
SID Code	50
SEP Code	50
PWD Code.....	51
Transfer Request	52
With transfer requests set in the system settings	55
On Hook Dial	56
Manual Dial	58
Changing the Line Port	59
Sub Transmission Mode	61
Book Fax.....	61
Two-Sided Transmission (Double-Sided Transmission)	62
Standard Message Stamp.....	64
Sending an Auto Document	65
Printing documents stored as Auto Documents	66
Sending a Stored File.....	67
Sending stored documents.....	67
Printing stored documents.....	70
Stamp.....	72
Transmission Options	73
Fax Header Print	73
Label Insertion	74
Sender Stamp.....	74
Reduced Image Transmission.....	74
Auto Reduce.....	74
Default ID Transmission	75
Selecting transmission options for a single transmission	75
More Transmission Functions.....	77
If Memory Runs Out While Storing an Original	77
Parallel Memory Transmission.....	77
Checking the Transmission Result.....	78
Automatic Redial	78
Batch Transmission.....	78
ECM (Error Correction Mode)	78
Dual Access	79
Transmission with Image Rotation	79
Simultaneous Broadcast	79
JBIG Transmission.....	80
Transmitting Journal by E-mail.....	80
Journal by E-mail.....	81

Printed Report	82
Memory Storage Report.....	82
Transmission Result Report (Memory Transmission).....	82
Communication Failure Report.....	83
Transmission Result Report (Immediate Transmission).....	83

5. Reception Features

Reception	85
Immediate Reception.....	85
Memory Reception.....	85
Substitute Reception.....	86
Receiving messages unconditionally.....	87
Receiving messages according to parameter-specified settings.....	87
Reception Functions	89
Transfer Station.....	89
Transfer Result Report.....	90
Transfer Result Report (transfer request by e-mail).....	91
Forwarding Received Documents.....	91
Routing Received Documents with SUB Code.....	92
Transferring Received Documents.....	93
SMTP Reception Using Internet Fax.....	93
Routing E-mail Received via SMTP.....	94
JBIG Reception.....	95
Auto Fax Reception Power-up.....	95
Printing Options	96
Print Completion Beep.....	96
Checkered Mark.....	96
Center Mark.....	96
Reception Time.....	97
Two-Sided Printing.....	97
180-Degree Rotation Printing.....	98
Multi-copy Reception.....	98
Image Rotation.....	99
Combine Two Originals.....	99
Page Separation and Length Reduction.....	100
Reverse Order Printing.....	100
Page Reduction.....	101
TSI Print (Transmitting Subscriber Identification Print).....	101
When There Is No Paper of the Correct Size.....	102
Setting priority trays.....	103
Just size printing.....	103
Having Incoming Messages Printed on Paper from the Bypass Tray.....	104
Where Incoming Message are Delivered - Output Tray	105
Specifying Tray for Lines.....	105
Tray Shift.....	105

6. LAN-Fax Features

Sending Fax Documents from Computers	107
Before Use	108
Installing the Software	108
Auto run program	108
Installing individual applications	109
Applications Stored on the CD-ROM	110
LAN-Fax Driver	110
Address Book	110
LAN-Fax Cover Sheet Editor	110
Setting LAN-Fax Properties	111
Basic Transmission	112
Attaching a cover sheet	113
Previewing fax images	114
Specifying options	114
Printing and Saving	115
Editing Address Book	116
Editing Fax Cover Sheets	118
Creating a cover sheet	118
Attaching a created cover sheet	118
LAN-Fax Operation Messages	119
LAN-Fax Error Report	120
LAN-Fax Result by E-mail	120
Viewing Fax Information Using a Web Browser	121
Viewing, Printing, and Deleting Received Fax Messages Using a Web Browser ...	121
Viewing received fax messages using a Web browser	121
Printing fax information using a Web browser	122
Deleting fax information using a Web browser	123
Viewing Received Messages on a Computer	124
Delivering Received Messages	124

7. Simplifying the Operation

Programs	125
Registering and Changing Keystroke Programs	125
Registering a priority function using a program	126
Changing a program name	127
Deleting a Program	127
Using a Program	128
Using the Document Server	129
Storing a Document	130
Changing Information of Stored Documents	132
Deleting a Stored Document	134
Managing Documents Saved in the Document Server from a Computer	135
Using DesktopBinder	135
Using a Web browser	135

8. Facsimile Features

Function List	137
Accessing User Tools (Facsimile Features)	141
Quitting Default Settings	141
General Settings/Adjustment	142
Reception Settings	144
E-mail Settings	145

9. Key Operator Setting

Key Operator Tools List	147
Using Key Operator Settings	149
Programming, Changing, and Deleting Standard Messages	149
Storing, Changing, and Deleting an Auto Document	150
Deleting an Auto Document.....	151
Programming, Changing and Deleting a Scan Size.....	152
Deleting a scan size	153
Printing the Journal	154
Counters.....	154
Forwarding	155
Programming an End Receiver	155
Quitting the forwarding function.....	156
Forwarding Mark.....	157
Memory Lock.....	157
ECM	158
User Parameters	159
Changing the User Parameters	162
Printing the User Parameter List	162
Special Senders to Treat Differently	163
Authorized Reception	164
Forwarding.....	165
Reception File Print Quantity.....	165
Print 2 Sided.....	165
Memory Lock.....	165
Reception Reverse Printing.....	165
Paper Tray.....	166
Programming/ Changing Special Senders	166
Programming Initial Set Up of a Special Sender	169
Deleting a Special Sender	171
Printing the Special Sender List	171
Box Settings	172
Programming/changing Personal Boxes	172
Deleting Personal Boxes	174
Programming/changing Information Boxes	175
Deleting Information Boxes	177
Programming/changing Transfer Boxes	178
Deleting Transfer Boxes.....	180
Printing the Box List.....	181
Transfer Report.....	181
Programming a Confidential ID	182

Programming a Polling ID	183
Programming a Memory Lock ID	183
Selecting Dial/Push Phone.....	184
Storing or Printing Received Documents	184
Reception Report e-mail.....	185
Setting a User Code for Viewing Received and Stored Documents	186

10.Solving Operation Problems

Reading Reports	187
Error Report	187
Power Failure Report	187
When an Error Occurs Using Internet Fax	189
Error Mail Notification.....	189
Error Report (Mail)	189
Server-Generated Error E-mail	189

11.Appendix

Replacing the Stamp Cartridge	191
Connecting the Machine to a Telephone Line and Telephone	192
Connecting the Telephone Line	192
Selecting the Line Type.....	193
Connecting the Optional Handset or an External Telephone.....	193
Optional Equipment.....	195
Fax Function Upgrade Unit	195
Expansion Memory (32MB: DIMM)	195
Handset.....	195
Extra G3 Interface Unit	195
Specifications.....	196
Compatible Machines.....	197
Acceptable Types of Originals	198
Acceptable original sizes	198
Paper size and scanned area.....	198
Maximum Values.....	201
INDEX.....	203

How to Read This Manual

Symbols

In this manual, the following symbols are used:

 **WARNING:**

This symbol indicates a potentially hazardous situation that might result in death or serious injury when you misuse the machine without following the instructions under this symbol. Be sure to read the instructions, all of which are included in "Safety Information", *General Settings Guide*.

 **CAUTION:**

This symbol indicates a potentially hazardous situation that might result in minor or moderate injury or property damage that does not involve personal injury when you misuse the machine without following the instructions under this symbol. Be sure to read the instructions, all of which are included in "Safety Information", *General Settings Guide*.

* The statements above are notes for your safety.

 **Important**

If this instruction is not followed, paper might be misfed, originals might be damaged, or data might be lost. Be sure to read this.

 **Preparation**

This symbol indicates information or preparations required prior to operating.

 **Note**

This symbol indicates precautions for operation, or actions to take after abnormal operation.

 **Limitation**

This symbol indicates numerical limits, functions that cannot be used together, or conditions under which a particular function cannot be used.

 **Reference**

This symbol indicates a reference.

[]

Keys that appear on the machine's display panel.

[]

Keys and buttons that appear on the computer's display.

[]

Keys built into the machine's control panel.

1. Transmission Mode

Sending at a Specific Time (Send Later)

Using this function, you can instruct the machine to delay transmission of your fax message until a specified later time. This allows you to take advantage of off-peak telephone charges without having to be by the machine at the time.

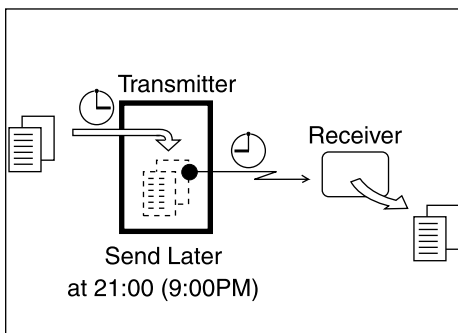

If you have a non-urgent fax, select Send Later with Economy Transmission when you scan it. Faxes will be queued in memory and sent during Economy Transmission Time.

Important

After the machine has been switched off for about one hour, all fax messages stored in memory are lost. If messages are lost for this reason, a Power Failure Report is automatically printed when the operation switch is turned on. Use this report to identify lost messages.

Limitation

This function is unavailable with Immediate Transmission. Use Memory Transmission.

Note

- You can specify a time within 24 hours.
- If the current time shown is not correct, change it. See "Timer Settings", *General Settings Guide*.
- If the document is sent before the specific time, Transmission Result Report is printed and the job is completed.
- For convenience, you can program the time when your phone charges become cheaper as the Economy Transmission Time. See p.143 "Program Economy Time".
- You can program one of the Quick Operation keys with operations for this function. Using the key allows you to omit steps 2 and 3.

1 Place the original, and then select the scan settings you require.

Reference

p.15 "Placing Originals", *Facsimile Reference* <Basic Features>

p.33 "Scan Settings", *Facsimile Reference* <Basic Features>

2 Press [Transmission Mode].

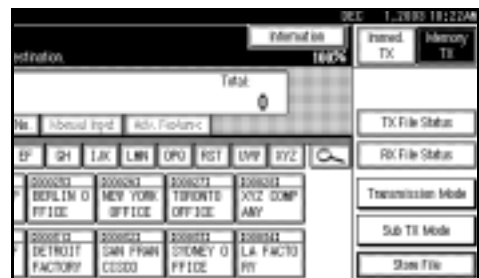

3 Press [Send Later].

- 4** Enter the time using the number keys, press **[AM]** or **[PM]**, and then press **[OK]**.

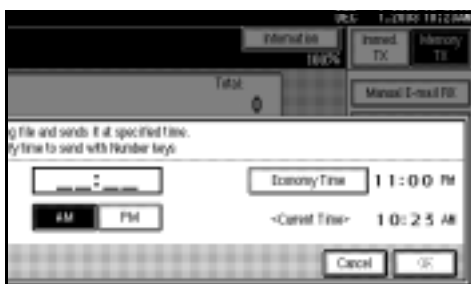

The specified time is shown above the highlighted **[Send Later]**.

Note

- r Press **[Economy Time]** to specify the economy time.
- r When entering numbers smaller than 10, add a zero at the beginning.
- r If you make a mistake, press **[Clear]** or the **[Clear/Stop]** key before pressing **[OK]**, and then try again.
- r To cancel Send Later, press **[Cancel]**. The display returns to that of step **3**.

- 5** Press **[OK]**.

The standby display appears.

Note

- r To check the settings, press **[Transmission Mode]**.

- 6** Specify a destination, and then press the **[Start]** key.

Note

- r You can cancel the transmission setup for Send Later. See p.19 "Canceling a Transmission".

User Transmission

This function allows you to check each user or department's transmission history. To use the function, you need to program a user code (eight digits max.) for each user or department, to be entered before transmission. See *General Settings Guide*.

If a user code set with an e-mail address is specified, a transmission result e-mail can be sent.

Note

- r You can program codes of up to 8 digits for a maximum of 100 users and/or departments. With the optional account enhance module installed, you can program user codes for a maximum of 500 users and/or departments. See *General Settings Guide*.
- r You can enter user codes or names into various lists or reports.
- r You can program transmission operations in Quick Operation key. Quick Operation key let you skip steps 2 and 3.
- r When you send an Internet Fax using the user code with e-mail address programmed and "Register as Sender" is set to "ON", the following sender name appears on the e-mail received by the other end.
 - When User Name is programmed in the user code:
User Name <E-mail address programmed in the user code>
 - When User Name is not programmed in the user code:
E-mail address programmed in the user code

- 1 Place the original, and then select desired scan settings.

Reference

p.15 "Placing Originals", *Facsimile Reference* <Basic Features>

p.33 "Scan Settings", *Facsimile Reference* <Basic Features>

- 2 Press [Transmission Mode].

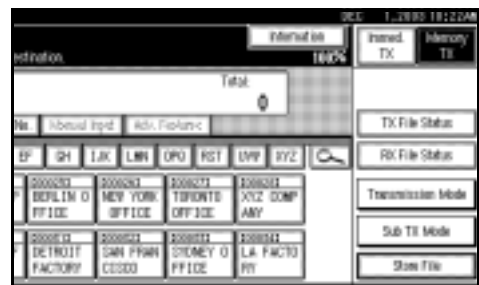

- 3 Press [User TX].

- 4 Using the number keys enter a user code (up to eight characters), and then press [#].



The programmed user name will appear.

Note

- r If you enter a wrong code, press [Clear] or the [Clear/Stop] key before pressing [#], and then try again.

- r To cancel the operation, press **[Cancel]**. The display returns to that of step **3**.

1

When your e-mail address is programmed with the user code

If your e-mail address is programmed with the user code, you can select whether the machine sends transmission result by e-mail.

A Press **[Yes]** or **[No]**.

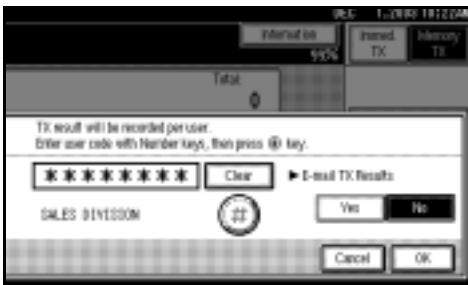

Note

- r If you select **[Yes]**, a Transmission Result Report is sent to the programmed e-mail address after the transmission so that you can check the result of transmission.

5 Press **[OK]** twice.

The standby display appears.

Note

- r To check the settings, press **[Transmission Mode]**.

6 Specify a destination, and then press the **[Start]** key.

Note

- r You can cancel the transmission setup for User Transmission. See p.19 "Canceling a Transmission".

Priority Transmission

Documents you send with Memory Transmission are sent in the order they are scanned. Therefore, if several messages are queued in memory, the next document will not be sent immediately. However, by using this function you can have your message sent before other queued messages.

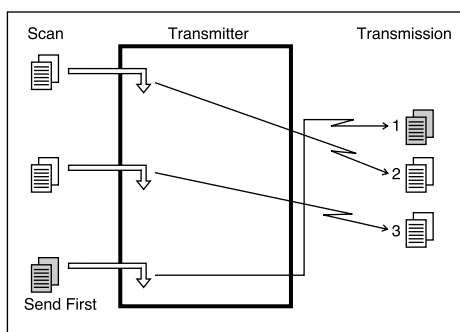

Limitation

This function is not available with Immediate Transmission. If this function is selected, the machine automatically switches to Memory Transmission.

Note

If there is already a message stored with this function or a transmission in progress, your message will be sent after that message has been transmitted.

1 Place the original, and then select the scan settings you require.

Reference

p.15 "Placing Originals", *Facsimile Reference* <Basic Features>

p.33 "Scan Settings", *Facsimile Reference* <Basic Features>

2 Press [Transmission Mode].

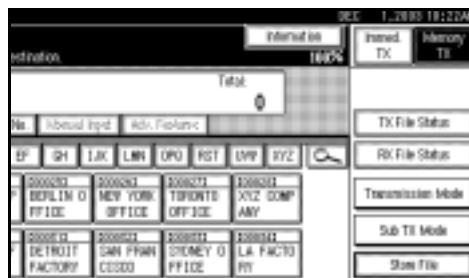

3 Press [Priority TX], and then press [OK].

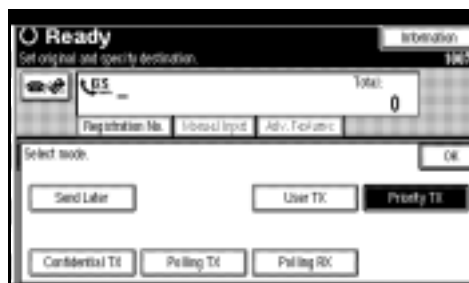

The standby display appears.

Note

To check the settings, press [Transmission Mode].

4 Specify the destination, and then press the [Start] key.

Note

Press [Change/Stop TX File] to cancel the transmission. See p.19 "Canceling a Transmission".

Confidential Transmission

1

If you want to limit who views your message, use this function. The message will be stored in memory at the other end and not printed until an ID is entered.

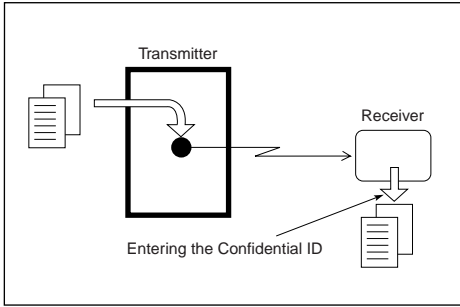

There are two types of Confidential Transmission:

v Default ID

It is not necessary to enter an ID when transmitting. The other party can print the message by entering the Confidential ID programmed in their machine.

v ID Override

Should you want to send a confidential message to a particular person at the other end, you can specify the Confidential ID that the receiver has to enter to see that message. Before you send the message, do not forget to tell the receiver the ID that must be entered to print the message.

! Limitation

- r The destination machine must be of the same manufacturer and have the Confidential Reception function.
- r The destination machine must have enough memory available.

✎ Note

- r We recommend that you program the Confidential ID beforehand. See p.182 "Programming a Confidential ID".
- r An ID can be any 4-digit number (except 0000).
- r If the destination machine is not of the same manufacturer, you can use Confidential Transmission with "SUB Code". See p.49 "SUB Code".
- r This function is not available with Internet Fax transmission.

1 Place the original, and then select the scan settings you require.

🔍 Reference

p.15 "Placing Originals", *Facsimile Reference* <Basic Features>
 p.33 "Scan Settings", *Facsimile Reference* <Basic Features>

2 Press [Transmission Mode].

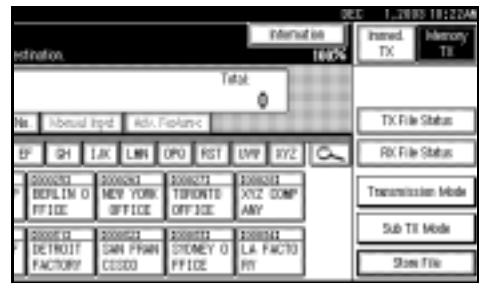

3 Press [Confidential TX].

- 4** Depending on the Confidential Transmission type, use one of the following procedures:

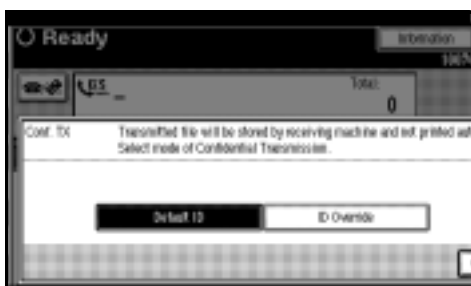

Default ID

- A** Check that **[Default ID]** has been selected, and then press **[OK]**.

"Default ID" is shown above the highlighted **[Confidential TX]**.

Note

- r To cancel Confidential Transmission, press **[Cancel]**. The display returns to that of step **3**.

Override ID

- A** Select **[ID Override]**.
- B** Enter the Confidential ID (4-digit number) using the number keys, and then press **[OK]**.

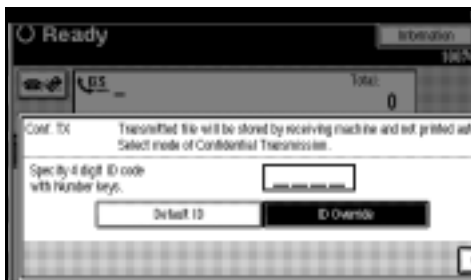

"ID Override" and the entered Confidential ID are shown above the highlighted **[Confidential TX]**.

Note

- r If you make a mistake, press **[Clear]** or the **[Clear/Stop]** key before pressing **[OK]**, and then try again.
- r To cancel Confidential Transmission, press **[Cancel]**. The display returns to that of step **3**.

- 5** Press **[OK]**.

The standby display appears.

Note

- r To check the settings, press **[Transmission Mode]**.

- 6** Dial, and then press the **[Start]** key.

Note

- r You can cancel the transmission setup for Confidential Transmission. See p.19 "Canceling a Transmission".

Polling Transmission

1

Use Polling Transmission when you want to leave an original in the machine memory for others to pick up. The message will be sent when the other party calls you up.

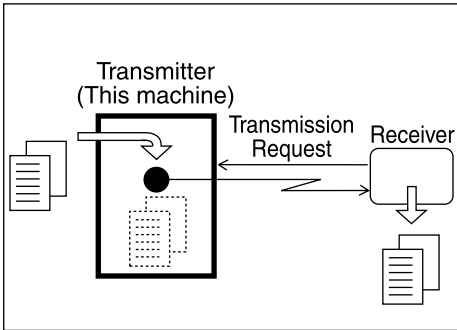

There are three types of Polling Transmission.

v Free Polling Transmission

It is not necessary to enter the Polling ID during the procedure. Anybody can poll the message from your machine. The machine sends it regardless of whether Polling ID's match.

v Default ID Transmission

It is not necessary to enter the Polling ID during the procedure. The message will only be sent if the Polling ID of the machine trying to poll your message is the same as the Polling ID stored in your machine. Make sure in advance that both machines' Polling IDs are identical.

v ID Override Transmission

You must enter an Override Polling ID unique to the transmission. This ID overrides the ID stored in the machine. The user must supply this ID when they poll your machine. If the IDs match, the message is sent. Make sure in advance the other end knows the ID you are using.

! Limitation

- r Polling Transmission is allowed only if the receiver's machine has the Polling Reception function.
- r Usually, only machines of the same manufacturer that support Polling Reception can perform ID Polling Transmission. However, when the Information Box File function is used, and the other party's fax machine supports Polling Transmission and the SEP function, you can still carry out Polling Transmission with an ID. See p.42 "Information Boxes".

✎ Note

- r Free Polling and Default ID Transmission allow only one file to be stored in memory.
- r ID Override Polling Transmission allows a file to be stored in memory for each ID; you can store up to 400 files (800 with the optional fax function upgrade unit) by changing IDs.
- r Before using Default ID Transmission, you need to program the Polling ID. See p.183 "Programming a Polling ID".

- r You can set whether a Polling Transmission file is deleted after transmitting in User Parameters. To save the file to transmit repeatedly, set to “Standby (Save)”. See p.159 “User Parameters” (switch 11, bit 7).
- r Polling Transmission Clear Report allows you to verify Polling Transmission has taken place. See p.12 “Polling Transmission Clear Report”. If E-mail TX Results is programmed in a Quick Operation key, you can select whether a report e-mail is sent after transmission. The destination of this report can be selected from the e-mail addresses in the destination list.
- r You can program one of the Quick Operation keys with operations for this function. Using the key allows you to omit steps 2 and 3.
- r The communication fee is charged to the receiver.
- r This function is not available with Internet Fax transmission.

1 Place the original, and then select the scan settings you require.

Reference

p.15 “Placing Originals”, *Facsimile Reference* <Basic Features>

p.33 “Scan Settings”, *Facsimile Reference* <Basic Features>

2 Press [Transmission Mode].

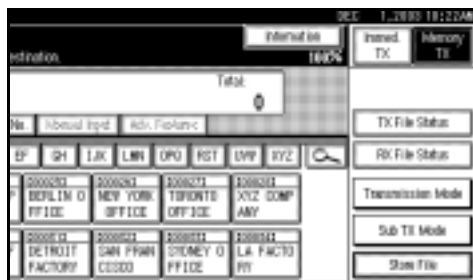

3 Press [Polling TX].

4 Depending on the Polling Transmission mode, use one of the following procedures:



Free Polling Transmission

A Check that [Free Polling TX] is selected.

Default ID Transmission

A Select [Default ID TX].

ID Override Transmission

A Select [ID Override Transmission].

B Specify a 4-digit ID using the number keys and [A], [B], [C], [D], [E], and [F].

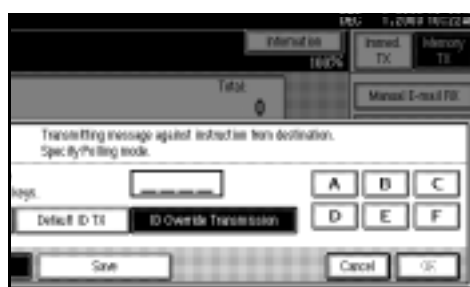

Note

- r A Polling ID may be any four numbers (0 to 9) and characters (A to F), except 0000 and FFFF.
- r If you make a mistake, press [Clear] or the [Clear/Stop] key, and then try again.

5 Press **[Only Once]** or **[Save]** to delete or save the file after transmission.

 **Note**

- r To delete the original immediately after transmission, select **[Only Once]**.
- r To repeatedly send the original, select **[Save]**.
- r To cancel Polling Transmission, press **[Cancel]**. The display returns to that of step **3**.

6 Press **[OK]**.

“* * * * *” appears.

The type of Polling Transmission is shown above the highlighted **[Polling TX]**.

7 Press **[OK]**.

 **Note**

- r To check the settings, press **[Transmission Mode]**.

8 Press the **[Start]** key.

 **Note**

- r You can cancel the transmission setup for Polling Transmission. See p.19 “Canceling a Transmission”.

Polling Transmission Clear Report

This report allows you to verify Polling Transmission has taken place.

If E-mail TX Results is programmed in a Quick Operation key, you can have the report e-mail sent after transmission.

 **Limitation**

- r This report is not printed if the User Parameters are set to allow the stored originals to be repeatedly sent (Save). See p.159 “User Parameters” (switch 11, bit 7).

 **Note**

- r You can turn this function on or off with the User Parameters. See p.159 “User Parameters” (switch 03, bit 6).
- r You can have a portion of the sent image printed on the report with the User Parameters. See p.159 “User Parameters” (switch 04, bit 7).
- r You can check the result of Polling Transmission with the Journal. See p.27 “Printing the Journal”
- r To view the report without text disruption, select a font of even character width in your e-mail application's settings.

Polling Reception

Use this function to poll a message from another terminal. You can also poll documents from many terminals with only one operation (use Groups and Keystroke Programs to fully exploit this function).

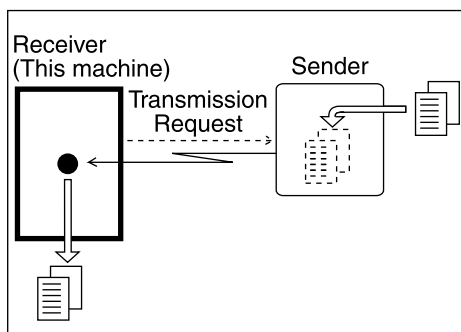

There are two types of Polling Reception.

v Default ID/Free Polling Reception

Use this method for Free Polling or Default ID Polling. If the Polling ID is programmed in your machine, any messages waiting in the transmitting machine with the same ID are received. If the other machine does not have any messages waiting with the same Polling ID, any messages that do not require ID are received (Free Polling).

v ID Override Polling Reception

You must enter an Override Polling ID unique to this transmission. This ID overrides the one stored in this machine.

Your machine will receive any messages waiting in the transmitting machine that have matching ID's. If no ID's match, any messages that do not require IDs are received (Free Polling).

! Limitation

- r Polling Reception requires that the other machine is capable of Polling Transmission.
- r Usually, you can only receive documents with a Polling ID from machines of the same manufacturer that support the polling function. However, if the other party's fax machine supports Polling Transmissions and the SEP function, and also has stored IDs, you can still perform Polling Reception. See p.50 "SEP Code".
- r To receive a message sent by Default ID Polling Transmission or ID Override Polling Transmission, it is necessary to specify the same Polling ID as the sender's. Free Polling Transmission does not require the same Polling ID.

📝 Note

- r For ID Polling Reception, program a Polling ID in advance. See p.183 "Programming a Polling ID".
- r Polling Result Report allows you to verify Polling Reception has taken place. See p.15 "Polling Result Report". If E-mail TX Results is programmed in a Quick Operation key, you can select whether a report e-mail is sent after reception. The destination of this report can be selected from the e-mail addresses in the destination list.
- r You can program one of the Quick Operation keys with operations for this function. Using the key allows you to omit steps 1 and 2.
- r This function is not available with Internet Fax.

1 Press **[Transmission Mode]**.

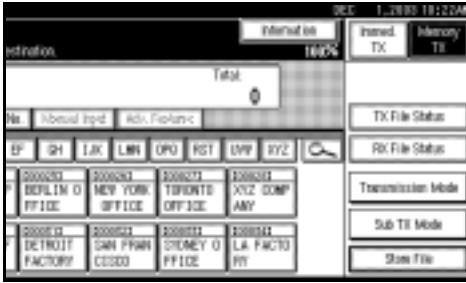

2 Press **[Polling RX]**.

3 Depending on which method you are using, select one of the following procedures:

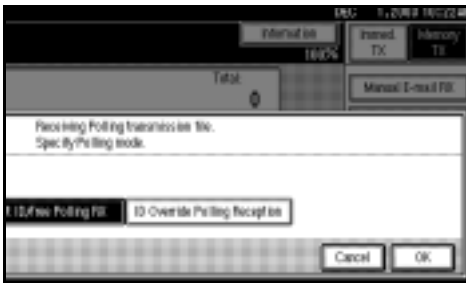

Default ID/Free Polling Reception

A Check that **[Default ID/Free Polling RX]** is selected, and then press **[OK]**.

"Default ID/Free Poll." is shown above the highlighted **[Polling RX]**.

Note

To cancel Polling Reception, press **[Cancel]**. The display returns to that of step **2**.

ID Override Polling Reception

A Select **[ID Override Polling Reception]**.

B Specify a 4-digit ID using the number keys and **[A]**, **[B]**, **[C]**, **[D]**, **[E]**, and **[F]**, and then press **[OK]**.

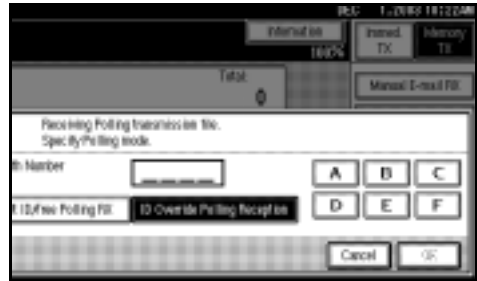

"ID Override" and the entered Polling ID are shown above the highlighted **[Polling RX]**.

Note

- r A Polling ID may be any four numbers (0 to 9) and characters (A to F), except 0000 and FFFF.
- r If you make a mistake, press **[Clear]** or the **[Clear/Stop]** key before pressing **[OK]**, and then try again.
- r To cancel Polling Reception, press **[Cancel]**. The display returns to that of step **2**.

4 Press **[OK]**.

The standby display appears.

5 Dial, and then press the **[Start]** key.

Polling Reserve Report

This report is printed after Polling Reception has been set up.

 **Note**

- r You can turn this function on or off with the User Parameters. See p.159 "User Parameters" (switch 03, bit 3).

Polling Result Report

This report is printed after a Polling Reception has been completed and shows its result.

If E-mail TX Results is programmed in a Quick Operation key, you can select whether a report e-mail is sent after reception.

 **Note**

- r You can also check the result of a Polling Reception with the Journal. See p.27 "Printing the Journal".
- r You can turn this function on or off with the User Parameters. See p.159 "User Parameters" (switch 03, bit 4).
- r To view the report without text disruption, select a font of even character width in your e-mail application's settings.

2. Checking and Canceling Transmission Files

After you have pressed the **[Start]** key (after scanning originals), you can check and edit the destination or settings of Memory Transmission. You can also cancel a transmission, change the settings of a transmission, print a stored file, print a list of stored files, and resend a file which the machine failed to transmit.

- Memory Transmission
- Internet Fax Transmission
- Send Later
- User Transmission
- Priority Transmission
- Confidential Transmission
- Polling Reception
- Polling Transmission
- Transfer Request

Note

- r If there are no files being sent, received, or stored by Memory Transmission, **[Change/Stop TX File]** does not appear on the display.
- r You cannot check or edit a file being sent or received. Also a Confidential Transmission file or stored file to be printed as a report cannot be checked or edited.

Displaying Confirmation of Transmission

1 Press [Change/Stop TX File].

5 Press [Exit].

The standby display appears.



2 Press [Check/Change Settings].



3 Select a file to check.



Note

- r If multiple destinations were specified, only the destination selected first appears.
- r If multiple destinations were specified, only the number of unsent messages appears.

4 Confirm a transmission, and then press [Exit].

Canceling a Transmission

You can cancel transmission of a file when the file is being sent, stored in memory, or fails to transmit. All the scanned data is deleted from memory.

You can cancel a file for Memory Transmission. This function is useful to cancel a transmission when you notice a mistake in destination or with the originals after storing. To cancel Memory Transmission, search for the file to be canceled among the files stored in memory, and then delete it.

Note

- r If you cancel a transmission while the file is being sent, some pages of your file may have already been sent and will be received at the other end.
- r If the transmission finishes while you are carrying out this procedure, transmission cannot be canceled.

1 Press [Change/Stop TX File].



2 Select a file whose transmission you want to cancel.



Note

- r To display only the files being sent, press **[Files under TX]**.
- r If multiple destinations were specified, only the number of unsent messages appears.
- r If multiple destinations were specified, only one destination number appears. To display all destinations, press **[Check/Change Settings]**.

3 Press [Stop Transmission].

The selected file is deleted.

Note

- r To quit transmission cancel, press **[Save]**.
- r To cancel another transmission, repeat from step 2.

4 Press [Exit].

The standby display appears.

Deleting a Destination

You can delete destinations.

Note

If you delete a destination that is the only destination for a transmission, the transmission is canceled.

2

1 Press [Change/Stop TX File].



2 Press [Check/Change Settings].



3 Select the file from which you want to delete a destination.



4 Press [Change] for the destination you want to delete.



Note

Press [Change] to switch the destination between fax number and e-mail address.

5 Press [Clear] to delete the destination.



Note

If you specified a destination using the number keys, pressing [Clear] deletes by single digits. If you specified a destination from the destination list, one press deletes the destination.

6 Press [Exit].

Note

To delete another destination, repeat from step 3.

7 Press [Exit].

The standby display appears.

Adding a Destination

Note

A destination cannot be added using a destination list.

1 Press [Change/Stop TX File].



2 Press [Check/Change Settings].



3 Select the file to which you want to add a destination.



4 Press [Add].



Note

Press  to switch the destination between fax number and e-mail address.

5 Specify the destination using the number keys or soft (on-screen) keys.

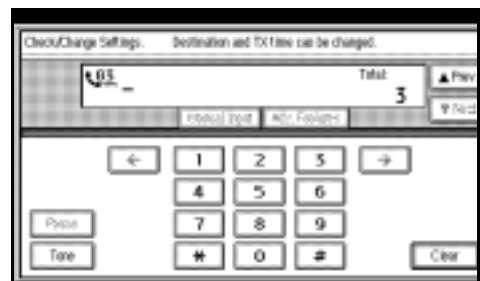

Note

To add e-mail address, press **[Manual Input]**, and then specify the destination.

You can also program a SUB Code by pressing **[Adv. Features]**.

6 Press [Exit].

Note

Repeat steps **4** and **5**, if you want to add another destination.

7 Press [Exit].

The standby display appears.

Changing the Transmission Time

You can change the transmission time specified with Send Later. See p.3 “Sending at a Specific Time (Send Later)”.

You can also delete the transmission time. If the transmission time is deleted, the file is transmitted immediately.

2

1 Press [Change/Stop TX File].



2 Press [Check/Change Settings].



3 Select the file for which you want to change or cancel the transmission time.



4 The recipient appears.

5 Press [Change TX time].



6 Press [Clear], and then re-enter the transmission time using the number keys or select [Economy Time], and then press [OK].



Note

- r If you select [Economy Time], the economy time already specified is entered. See p.142 “General Settings/Adjustment”.
- r If you press [Transmit Now], the file is transmitted immediately. However, if there is a file on standby, that file is sent first.

7 Press [Exit].

Note

- r Repeat from step **3**, if you want to change another transmission time.

8 Press [Exit].

The standby display appears.

Printing a File

If you want to check the contents of a file that is stored in memory and not yet sent, use this procedure to print it out.

Note

- r Confidential Transmission files are displayed, but cannot be printed.
- r You can also print files that have not been successfully transmitted.

1 Press [Change/Stop TX File].



2 Press [Print File].



3 Select the file you want to print.



Note

- r If multiple destinations were specified, only the number of unsent messages appears.
- r If you want two-sided printing (optional), press **[Print 2 Sides]**.
- r To cancel printing, press **[Cancel]**. The display returns to that of step **3**.

4 Press the [Start] key.

Note

- r To cancel printing after pressing the **[Start]** key, press **[Stop Printing]**. The display returns to that of step **3**.

5 Press [Exit].

The standby display appears.

Note

- r Repeat from step **3**, if you want to print another file.

Resending a File

Machine memory stores messages that could not be successfully transmitted using Memory Transmission. Use this procedure to resend these messages.

2

Preparation

You should select “Store for 24 hours” for “Store a message that could not be transmitted” in User Parameters. See p.159 “User Parameters” (switch 24, bit 0).

Note

Files that could not be transmitted will be kept for either 24 or 72 hours depending on how you program this function. See p.159 “User Parameters” (switch 24, bit 1).

1 Press [Change/Stop TX File].



2 Press [Transmit Failed File].

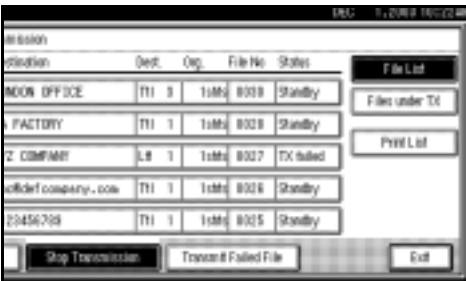

3 Select the file you want to resend.

“TX failed” is displayed for files that could not be sent.



Note

- If multiple destinations were specified, only the destination number appears.
- If multiple destinations were specified, only the number of unsent messages appears.

4 Press [OK].

Note

- To add destinations, press [Add], and then specify the destinations.
- To cancel transmissions, press [Cancel]. The display returns to that of step 3.
- Repeat from step 3 to resend another file.

5 Press [Exit].

The standby display appears. Transmission starts.

Printing a List of Files in Memory (Print TX File List)

Print this list if you want to find out which files are stored in memory and what their file numbers are. Knowing the file number can be useful (for example when erasing files).

Note

The contents of a file stored in memory can also be printed. See p.23 “Printing a File”.

1 Press **[Change/Stop TX File]**.



2 Press **[Print List]**.



Note

To cancel printing before pressing the **[Start]** key, press **[Cancel]**. The display returns to that of step **2**.

3 Press the **[Start]** key.

Note

To cancel printing after pressing the **[Start]** key, press **[Stop Printing]**. The display returns to that of step **2**.

4 Press **[Exit]**.

The standby display appears.

3. Communication Information

Printing the Journal

The Journal contains information about the last 50 communications (maximum) made by your machine. It is printed automatically after every 50 communications (receptions & transmissions).

You can also print a copy of the Journal at any time by following the procedure below.

If the machine is installed with the optional extra G3 interface unit, you can print the Journal of each line type.

Important

The contents of a Journal printed automatically are deleted after printing. Keep the journal if you require a record of transmissions and receptions. You can check a total of 200 communications (receptions & transmissions) on the display.

v All

Prints the results of communications in the order made.

v Print per File No.

Prints only the results of communications specified by file number.

v Print per User Code

Prints only the results of communications through User Code Management or User Transmission. See p.11 "User code entry display", *Facsimile Reference <Basic Features>* and p.5 "User Transmission".

Note

- r The setting on the machine can be changed so that user codes will be printed instead of user names. For more information, contact your service representative.
- r The sender name column of the Journal is useful when you need to program a special sender. See p.163 "Special Senders to Treat Differently".
- r You can set whether the Journal is automatically printed after every 50 communications in User Parameters. See p.159 "User Parameters" (switch 03, bit 7).
- r You can set whether you print the Journal by line type. See p.159 "User Parameters" (switch 19, bit 1).
- r You can program one of the Quick Operation keys with operations for this function. Using the key allows you to omit steps 1 and 2.

1 Press [Information].



2 Press [Print Journal].

3 Select a printing mode.



All

A Select **[All]**.

Print per File No.

A Select **[Print per File No.]**.

B Enter a 4-digit file number.



Note

r If you make a mistake, press **[Clear]** or the **[Clear/Stop]** key, and then try again.

Print per User Code

A Select **[Print per User Code]**.

B Specify a user code of up to 8 digits using the number keys, and then press **[#]**.



Note

r If you make a mistake, press **[Clear]** or the **[Clear/Stop]** key before pressing **[#]**, and then try again.

C Check the user name shown on the display.

4 Press the **[Start]** key.

Note

r To cancel a file printing, press **[Stop Printing]**. The display returns to that of step **2**.

5 Press **[Exit]** twice.

The standby display appears.

Journal

*** Journal (1. Dec. 2003 6:38PM) ***										
										P. 1
										1) ABC.COMPANY 2) DESIGN (Manual print)
<TX>	Date	Time	Destination	Mode	TXtime	Page	Result	Pers. Name	File No.	
	1. Dec.	2:35PM	NEW YORK OFFICE	G3TESM	0'31"	P.1	OK		0528	
		2:36PM	LONDON OFFICE	G3TESM	0'07"	P.2	OK		0529	
		2:40PM	PARIS OFFICE	G3TESM	0'01"	P.1	OK		0530	
		6:27PM	-LAN-Fax->	*DM	0'02"	P.1	OK	DESIGN	0536	
		6:28PM	NEW YORK OFFICE	G3TEDM	0'53"	P.1	OK	DESIGN	0536	
		7:25PM	aaa@abc.company.com:3	☞TS	0'01"	P.1	---		0537	
<RX>	Date	Time	Sender	Mode	RXtime	Page	Result	Pers. Name	File No.	
	1. Dec.	2:45PM	PARIS OFFICE	G3RES	0'04"	P.1	OK		0531	
		2:49PM	NEW YORK OFFICE	G3RESC	0'11"	P.2	OK		0532	
		2:00PM	LONDON OFFICE	G3RED	0'03"	P.1	OK		0533	
		2:30PM	LA FACTORY	G3RES	0'02"	P.1	OK		0534	
		2:32PM	BERLIN OFFICE	G3REF	0'03"	P.1	OK+		0535	
T X Count		00021			R X Count		00020			
# : Batch	C : Confidential	\$: Transfer	P : Polling							
M : Memory	L : Send later	@ : Forwarding	E : ECM							
S : Standard	D : Detail	F : Fine	U : Super Fine							
> : Reduction	H : Stored/D.Server	* : LAN-Fax	+ : Delivery							
Q : RX Notice Req.	A : RX Notice									

1. Printing date

Shows the date and time when the report is printed.

2. Programmed sender name

Shows the sender name programmed for printing.

3. Date

Shows the transmission or reception date.

4. Time

Shows the transmission or reception start time.

5. Other end

- For fax destinations
Shows the name (for display) programmed by the other end. Shows the programmed fax number if the name (for display) has not been programmed.
If neither name nor fax number has been programmed by the other end, an entered fax number or a name programmed in a destination list is shown for transmissions. The space will be blank for receptions.
To prioritize a fax number or name programmed in the destination list, contact your service representative.

- For Internet Fax destinations
Shows the e-mail address or name programmed in the destination list for transmissions. Shows the number of the destinations after an e-mail address or a name for broadcasting transmissions.
Shows the e-mail address of the sender for receptions.

6. Communication mode

- For fax transmissions and receptions
After "T" for outgoing fax or "R" for ingoing fax, shows a communication mode. If the optional Extra G3 interface unit has been installed, "G3-1", "G3-2", or "G3-3" will be shown.
- For Internet Fax transmissions and receptions
After \diamond the e-mail symbol, and "T" for outgoing e-mail or "R" for ingoing e-mail, the communication mode appears in alphabetical letters or symbols. Outgoing e-mail set for Reception Notice of E-mail Options bears a "Q", whereas "A" appears with reception confirmation e-mails.

7. Communication time

Shows time taken for transmissions or receptions.

8. Number of pages

Shows the number of pages transmitted or received.

9. Communication result

Shows the result of transmissions or receptions.

OK: All pages were properly transmitted or received. When Reception Notice is activated using the Internet Fax E-mail Options, receipt of Reception Notice is shown.

--: The Internet Fax was sent to the mail server programmed in this machine. (However, this does not mean the e-mail was delivered.)

Error: A communication error occurred.

D: Power was disconnected during communication. Not all fax messages were transmitted.

10. User name

Shows the user name programmed for user code use restriction or User Transmission.

11. File number

Shows file management numbers.

Checking the Transmission Result (TX File Status)

You can browse a part of the Transmission Result Report on the display.

Note

- r Only the transmission result of the last 200 communications (receptions & transmissions) are shown.
- r If a transmission is completed while you are using this function, the result will not appear. To view the latest result, exit TX File Status, and then try again.
- r You can program one of the Quick Operation keys with operations for this function. Using the key allows you to omit steps **1** and **2**.

1 Press [Information].



2 Select [TX File Status].

3 Check the transmission results.

Date/Time	Destination	Original
Dec. 1 11:35 AM	AEC COMPANY	
Dec. 1 11:25 AM	NEW YORK OFFICE	
Dec. 1 11:22 AM	LONDON OFFICE	
Dec. 1 10:35 AM	TORONTO OFFICE	
Dec. 1 10:28 AM	X STORE	
Dec. 1 10:15 AM	PARIS OFFICE	

Transmission results are displayed, from the latest result down, in groups of six.

Note

- r When a fax is sent, "Destination" shows the Own Fax Number or Fax Header information of a receiver. The e-mail address and name programmed in the destination list appears in the "To" field of the sent Internet Fax. For a transmission from a computer, "-- LAN-Fax -->" is shown.

4 Press [Exit] twice.

The standby display appears.

Checking the Reception Result (RX File Status)

You can browse a part of the Reception Result Report on the display.

Note

- r Only the reception result of the last 200 communications (receptions & transmissions) are shown.
- r If a message is received while you are using this function, the result will not appear. To view the latest result, exit RX File Status, and then try again.
- r You can program one of the Quick Operation keys with operations for this function. Using the key allows you to omit steps 1 and 2.

Note

- r When a fax is received, Transmission Station shows the fax number of a sender or Fax Header information. The sender's e-mail address appears in the "From" field of the received Internet Fax.

4 Press [Exit] twice.

The standby display appears.

1 Press [Information].



2 Select [RX File Status].

3 Check the reception results.

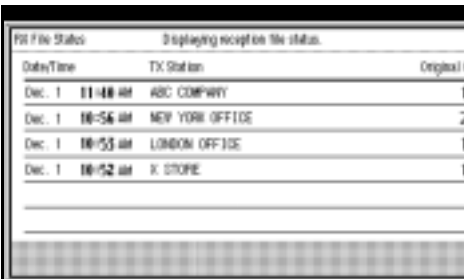

Reception results are displayed from the latest result in groups of six.

Displaying the Memory Status

Use this function to display a summary of current memory usage. Items shown are the percentage of free memory space, the number of received confidential messages, the number of files to be sent, the number of Memory Lock files and the number of received messages to be printed.

1 Press [Information].



2 Press [Memory Status].

3 Check the memory status.

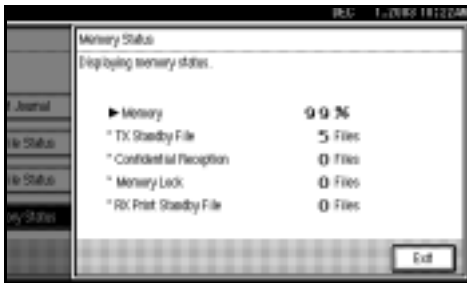

Note

r "Others" will be displayed:

- When storing attachment files. See p.65 "Sending an Auto Document".
- When storing Transfer Request files. See p.52 "Transfer Request".
- When storing originals in the Information Boxes. See p.42 "Storing Messages in Information Boxes".

- When sending to the Personal Box. See p.41 "Printing Personal Box Messages".

r If you have made the machine save received messages on the hard disk, see "RX Print Standby File" on the display to check the number.

4 Press [Exit] twice.

The standby display appears.

Printing/Deleting Received and Stored Documents (Print Stored RX File)

The optional printer/scanner unit is required.

You can print documents that are received and stored on the hard disk. You can also delete unwanted documents.

3

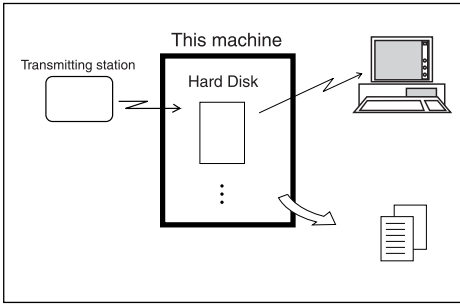

Preparation

Make a setting for received and stored documents before using this function. See p.184 “Storing or Printing Received Documents”.

Note

- r If you have selected to store received documents and specified an e-mail address for notification of receipt, fax reception notification can be sent to that e-mail address. See p.185 “Reception Report e-mail”.
- r You can view and/or print received and stored documents using a Web browser or DesktopBinder V2 Lite. See p.121 “Viewing Fax Information Using a Web Browser” or the DesktopBinder V2 Lite’s manuals and Help.

Printing Received and Stored Documents

Use the following procedure to print documents saved on the hard disk.

Note

- r This function allows you to print only received and stored documents.
- r You cannot print and delete received documents using the Document Server function.
- r You can specify and print multiple documents. You can specify a maximum of 30 documents at one time.

1 Press [Information].



2 Press [Print Stored RX File].

- 3 Select a file to be printed, and then press [Print].



- 4 Select the printing mode, and then press the [Start] key.

Note

- r To cancel printing, press [Cancel]. The display returns to that of step 3.
- r To delete the document after printing, press [Delete File after Printing].
- r To perform 2-sided printing (optional duplex unit required), press [Print on 2 Sides] before pressing the [Start] key.

- 5 Press [Exit] twice.

The standby display appears.

Deleting Received and Stored Documents

Use the following procedure to delete documents stored on the hard disk.

Note

- r You cannot delete a document while another person is previewing or printing it using a Web browser or DesktopBinder V2 Lite.

- 1 Press [Information].



- 2 Press [Print Stored RX File].

- 3 Select a file to be deleted, and then press [Delete].

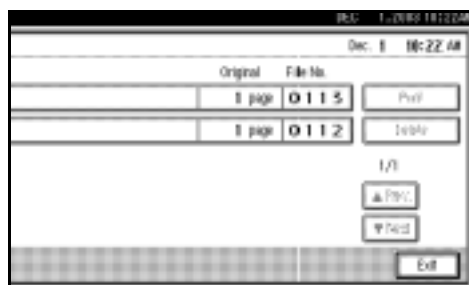

- 4 Press [Yes].

Note

- r To cancel a deletion, press [No]. The display returns to that of step 3.

- 5 Press [Exit] twice.

The standby display appears.

Printing a Confidential Message

This function is designed to prevent unauthorized users from reading your messages. If someone sends you a message using Confidential Transmission, it is stored in memory but not automatically printed. To print the message you have to enter the Confidential ID Code. When your machine has received a confidential message, the **Confidential File** (☒) indicator lights.

3

Preparation

Before using this function, program your Confidential ID. See p.182 “Programming a Confidential ID”.

Important

If the main power switch is off more than one hour, all confidential messages are deleted. When this happens, use the Power Failure Report to identify which messages have been deleted. See p.187 “Power Failure Report”.

Limitation

You must program the Confidential ID for Confidential Reception to work.

Note

You can program one of the Quick Operation keys with operations for this function. Using the key allows you to omit steps 2 and 3.

1 Confirm that the Confidential File indicator is lit.

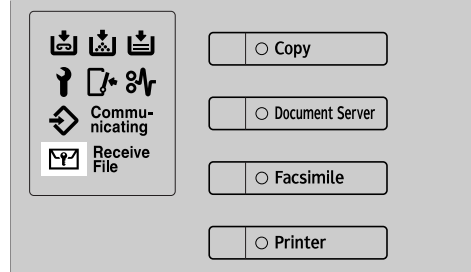

2 Press [Information].



3 Press [Print Confidential RX File].

Note

If no confidential messages have been received, the message “No reception file.” is shown. Press [Exit].

4 Enter a 4-digit Confidential ID using the number keys, and then press the [Start] key.

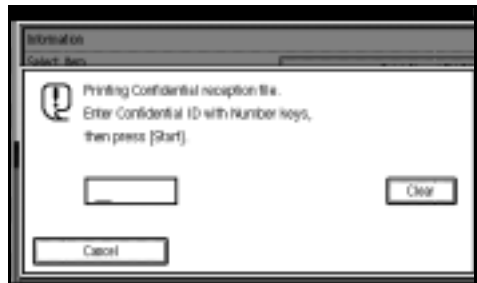

The Confidential ID differs depending on the Sender's specifications.

 **Note**

- r You must enter the Confidential ID programmed in this machine, if the received file has no Confidential ID.
- r You must enter the Confidential ID programmed by the sender. Confirm the sender's Confidential ID in advance.
- r If the Confidential IDs or Personal Confidential IDs do not match, the message "No reception file under specified Confidential ID." appears. Press **[Exit]** to cancel the operation, and then check the Confidential ID or Personal Confidential ID with the other party, and then try again.

5 Press **[Exit]**.

The standby display appears.

 **If you cannot print confidential files even if the Confidential File (📧) indicator is lit.**

The Confidential File indicator also lights if the machine received a message with a SUB Code. Check the Personal Boxes.

 **Note**

- r Print from the Personal Box, when a file has been sent from another party with a SUB Code attached. See p.41 "Printing Personal Box Messages".

Confidential File Report

When this function is turned on, this report is printed whenever your machine receives a confidential message.

 **Note**

- r You can turn this function on or off with the User Parameters. See p.159 "User Parameters" (switch 04, bit 0).

Printing a File Received with Memory Lock

3

This is a security function designed to prevent unauthorized users from reading your messages. If Memory Lock is switched on, all received messages are stored in memory and are not automatically printed. To print the messages, you have to enter the Memory Lock ID Code. When your machine has received a message with Memory Lock, the **Confidential File** (🔒) indicator blinks.

Preparation

Before using this function, program your Memory Lock ID. See p.183 “Programming a Memory Lock ID”.

Before using this function, set Memory Lock to On. See p.165 “Memory Lock”.

Important

If the main power switch is turned off for more than an hour, all messages protected by Memory Lock will be deleted. In that case, the Power Failure Report will be printed so you can confirm which messages have been deleted. See p.187 “Power Failure Report”.

Note

If free memory space is not enough, messages may not be received. If it is not enough while received document storage is set, the oldest received messages are printed and new message is received. However, both received document storage and Memory Lock are set, Memory Lock is not available.

- r You can also apply a Memory Lock to messages that come only from certain senders. See p.166 “Programming/ Changing Special Senders”.
- r Messages received by Polling Reception are automatically printed even if this function is switched on.
- r You can program one of the Quick Operation keys with operations for this function. Using the key allows you to omit steps 2 and 3.

1 Confirm that the Confidential File indicator is blinking.

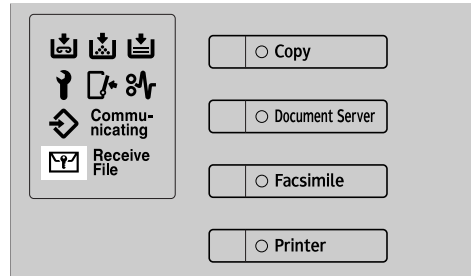

2 Press [Information].



3 Press [Print Memory Lock].

Note

If no messages were received while Memory Lock was switched on, the message “No reception file.” is shown. Press [Exit].

- 4 Enter a 4-digit Memory Lock ID with the number keys, and then press the **[Start]** key.

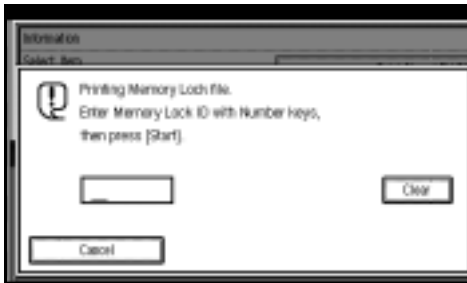

 **Note**

- r If the Memory Lock ID does not match, the message "Specified code does not correspond to programmed Memory Lock ID." appears. Press **[Exit]** and retry after checking the Memory Lock ID.

- 5 Press **[Exit]**.

The standby display appears.

Personal Boxes

Preparation

Before using this function, set the Personal Box in advance. See p.172 "Programming/changing Personal Boxes".

Personal Boxes

This function lets you set up the machine so that incoming messages addressed to certain users are stored in memory instead of being printed out immediately.

Each user must be assigned a SUB Code (Personal Code) that has been designated as a Personal Box beforehand. When the other party sends their message, they specify the SUB Code of the receiver. When the message is received, it is stored in the Personal Box with the matching SUB Code. In order to print a received message, you must enter the SUB Code assigned to that Personal Box.

This enables several individuals or departments to share a single fax machine yet be able to differentiate between messages. Furthermore, if you specify a receiver for the Personal Box, instead of being stored in memory, incoming messages with this SUB Code appended are forwarded directly to the destination you specify. You can specify a fax number or an e-mail address. See p.172 "Programming/changing Personal Boxes".

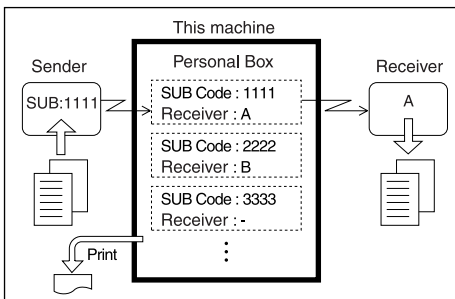

- To be able to receive messages into a Personal Box you must inform the sender of the SUB Code programmed for that Personal Box and ask them to send the message using SUB Code Transmission with that SUB Code. See p.49 "SUB Code".
- When messages have been received into Personal Boxes, the Confidential Reception/Memory Lock indicator lights and the Confidential File Report is printed. See p.37 "Confidential File Report".
- If a Personal Box is assigned a receiver, incoming messages are transferred to that receiver with a Forwarding Mark stamped on them. See p.157 "Forwarding Mark".
- If a receiver is not assigned, print these messages. See p.41 "Printing Personal Box Messages".

v SUB Code and SEP Code

SUB Code and SEP Code are IDs consisting of up to 20 digits, and can include numbers, #, *, and spaces. To use this function, you must program a box and SUB/SEP Code beforehand. The other party can send messages to, and retrieve stored messages from, this box using the code.

Note

- r This function is not available when you have set received documents to be delivered to the network delivery server.

Printing Personal Box Messages

Follow these steps to print a message that has been received into a Personal Box.

Note

If you print a Personal Box message, it is deleted.

1 Make sure that the Confidential File indicator is lit.

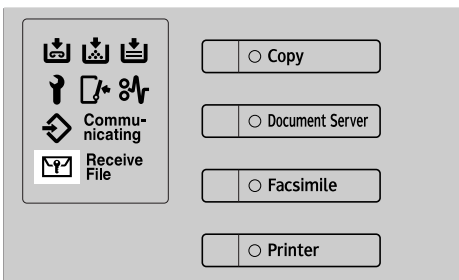

2 Press [Information].



3 Press [Print Personal Box File].

4 Select the box with the message you want to print.

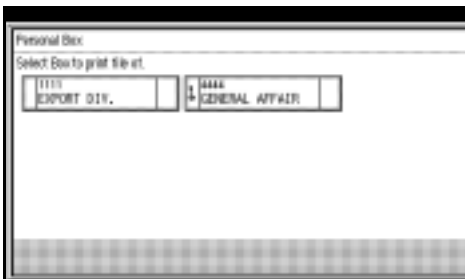

When a password is required

The display appears, when the selected Personal Box password is set in advance.

Note

The password is programmed in "Key Operator Tools". See p.172 "Programming/changing Personal Boxes".

A Enter the password, and then press [OK].



Note

If you make a mistake, press [Clear] or the [Clear/Stop] key before pressing [OK], and then try again.

To cancel entering a password, press [Cancel]. The display returns to that of step 4.

5 Press the [Start] key.

Note

To stop printing, press [Stop Printing]. The display returns to that of step 4.

6 Press [Exit].

Note

To print a message in another Personal Box, refer to step 4, and then try again.

7 Press [Exit].

The standby display appears.

Information Boxes

Preparation

Before using this function, set the Information Box in advance. See p.175 “Programming/changing Information Boxes”.

Information Boxes

Use the Information Box function to set up the machine as Document Server. By scanning documents into Information Boxes, other parties can receive these messages whenever they request them.

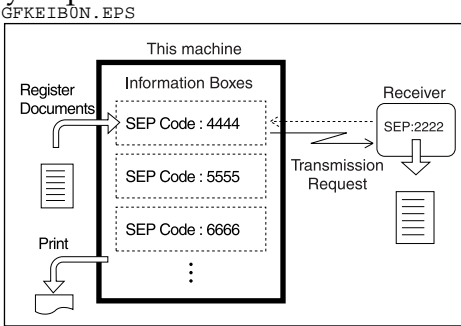

- You can program documents for this function with “Store/Delete/Print Information Box File”. See p.42 “Storing Messages in Information Boxes”.
- For other parties to be able to retrieve a message programmed in an Information Box, you need to inform them of the SEP Code assigned to that Information Box.
- When an SEP Code Polling Reception request is made by another party, the SEP Code they specify is matched against the SEP Codes programmed in that Information Boxes. If a code matches, the message stored in the Information Box is sent to the other party automatically. See p.49 “SUB Code”.

- You can check the contents of Information Boxes with “Store/Delete/Print Information Box File”. See p.44 “Printing Information Box Messages”.
- You can set a password for Information Boxes in advance. A password can be set in “Key Operator Setting”. See p.175 “Programming/changing Information Boxes”.

Storing Messages in Information Boxes

Follow these steps to store a message in an Information Box.

Note

- r One Information Box stores one file.
- r The stored file is not deleted automatically. If you want to delete a stored file, see p.45 “Deleting Information Box Messages”.

1 Press [Information].



2 Press [Store/Delete/Print Information Box File].

- 3** Select the box in which you want to store the file.



Note

- r When there are pre-programmed files, a file mark is displayed at the end of the Box Name.
- r A message is displayed, when selecting a box with a file stored in it. Press **[Yes]**, when changing the file name. The file stored originally will be overwritten.

When a password is required

- A** Enter the password, and then press **[OK]**.



Note

- r If you make a mistake, press **[Clear]** or the **[Clear/Stop]** key before pressing **[OK]**, and then try again.
- r To cancel entering a password, press **[Cancel]**. The display returns to that of step **3**.

- 4** Place the original, and then select the scan settings you require.



Note

- r You can also select the following settings:
 - Book Fax
 - Two-Sided Original (The optional ADF is required.)
 - Stamp ADF is required.

Reference

p.15 "Placing Originals", *Facsimile Reference* <Basic Features>

p.33 "Scan Settings", *Facsimile Reference* <Basic Features>

- 5** Press the **[Start]** key.

The machine starts to scan the original.

To stop scanning, press **[Stop Scanning]**. The display returns to that of step **3**.

- 6** Press **[Exit]**.

Note

- r To store a message in another Information Box, return to step **3**.

- 7** Press **[Exit]**.

The standby display appears.

Printing Information Box Messages

Follow these steps to print a message stored in an Information Box.

1 Press [Information].



2 Press [Store/Delete/Print Information Box File].

3 Press [Print File].

4 Select the box that contains the stored file you want to print.



Note

r You cannot select a box that has no stored file.

When a password is required

A Enter the password, and then press [OK].



Note

- r If you make a mistake, press [Clear] or the [Clear/Stop] key before pressing [OK], and then try again.
- r To cancel entering a password, press [Cancel]. The display returns to that of step 4.

5 Press the [Start] key.

Note

- r If you want two-sided printing (optional), press [Print 2 Sides] before pressing the [Start] key.
- r To stop printing before pressing the [Start] key, press [Cancel]. The display returns to that of step 4.
- r To stop printing after pressing the [Start] key, press [Stop Printing]. The display returns to that of step 4.

6 Press [Exit].

Note

r Repeat from step 4 to print another stored file in the box.

7 Press [Exit].

The standby display appears.

Deleting Information Box Messages

Follow these steps to delete a file stored in an Information Box.

1 Press **[Information]**.



2 Press **[Store/Delete/Print Information Box File.]**.

3 Press **[Delete File]**.

4 Select the box that contains the stored file you want to delete.



When a password is required

A Enter the password, and then press **[OK]**.



Note

- r If you make a mistake, press **[Clear]** or the **[Clear/Stop]** key before pressing **[OK]**, and then try again.
- r To cancel entering a password, press **[Cancel]**. The display returns to that of step **4**.

5 Press **[Delete]**.

Note

- r To stop deleting, press **[Do not Delete]**. The display returns to that of step **4**.

6 Press **[Exit]**.

Note

- r Repeat from step **4** to delete another stored file in another box.

7 Press **[Exit]**.

The standby display appears.

4. Other Transmission Features

Handy Dialing Functions

Chain Dial

This allows you to compose a telephone number from various parts, some of which may be stored in Quick Dials and some of which may be entered using the number keys.

 **Note**

- r Maximum length of a telephone or fax number: 128 digits
- r For Memory Transmission and Immediate Transmission, insert a pause between parts of a number. For On Hook Dial and Manual Dial, no pause is needed.
- r You cannot use this function with Internet Fax transmission.
- r The Advanced Features function programmed in the destination list is unavailable.

(Example) 01133-1-555333

Assume that 01133 is stored in a Quick Dial key.

- 1** Place the original, and then select the scan settings you require.
- 2** Press the Quick Dial key that is programmed "01133".
- 3** Press the **[Pause/Redial]** key.
- 4** Enter **[1]**, **[5]**, **[5]**, **[5]**, **[3]**, **[3]**, **[3]** using the number keys.
- 5** Press the **[Start]** key.

Redial

The machine stores the last 10 destinations specified. If you want to send a message to a destination which you sent faxes to recently, the Redial function saves you time by finding and entering the destination again.

 **Limitation**

- r The following kinds of destinations are not stored:
 - Quick Dials
 - Group Dials
 - Destinations dialed as Receiving Stations for Transfer Request
 - Forwarding terminal of the Substitute Reception
 - Destinations dialed using the external telephone
 - Destinations dialed by Redial (regarded as already stored in memory)
 - Second and later destinations broadcasted to
- r To redial a fax number, do not dial any numbers before you press the **[Pause/Redial]** key. If you press the **[Pause/Redial]** key after entering numbers using the number keys, a pause will be entered instead. To redial e-mail address, do not enter any characters before you press **[Manual Input]**.

 **Note**

- r Redial can be used to specify Internet Fax recipients.

1 Place the original, and then select the scan settings you require.

2 Press the **[Pause/Redial]** key.

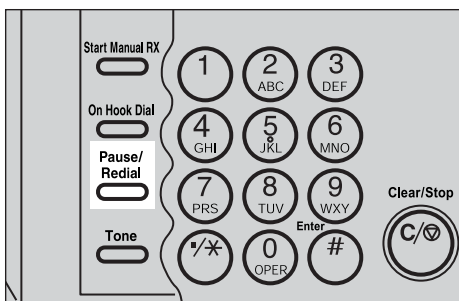

4

3 Select the destination you want to redial to.



Note

- r Now that the date and time the original was read appears as a key, select by pressing it.
- r When you press **[ProgDest]**, you can register a selected recipient in the destination list.

Advanced Features

SUB Code

Normally you can only use Confidential Transmission to send messages to fax machines of the same manufacturer that have the Confidential Reception function. See p.8 “Confidential Transmission”. However, if the other machine supports a similar function called “SUB Code”, you can send fax messages to the other party using this method instead.

Note

- r The ID can be up to 20 digits long.
- r You can enter numbers, *, #, and spaces to program an ID.
- r Make sure the number of digits in the ID matches the specification of the machine to which you are sending.
- r You can store IDs in destination lists and Programs. See "Registering a Fax Destination", *General Settings Guide*. See p.125 "Registering and Changing Keystroke Programs".
- r Messages you send using this function are marked "SUB" on all reports.
- r This function is not available with Internet Fax transmissions.

- 1** Place the original, and then select the scan settings you require.

Reference

p.15 “Placing Originals”, *Facsimile Reference* <Basic Features>

p.33 “Scan Settings”, *Facsimile Reference* <Basic Features>

- 2** Dial the fax number using the number keys.

- 3** Press [Adv. Features].



- 4** Press [SUB Code].

- 5** Press [TX SUB Code].

- 6** Enter a SUB Code, and then press [OK].



"SUB Code" appears one line above [Adv. Features] on the display.

Note

- r If you make a mistake, press [Cancel] or the [Clear/Stop] key before pressing [OK], and then try again.

- 7** To enter a password, press [Password (SID)].

- 8** Enter the password with the number keys, and then press [OK].

- 9** Press [Exit].

10 Press the **[Start]** key.

Note

- r If you use Immediate Transmission and the fax machine at the destination does not support the SUB Code function, a message will appear on the display to inform you of this. When this happens, press **[OK]** to cancel the transmission.

SID Code

There are times when you may want to use an "SID" (Sender ID) when sending confidential faxes with the SUB Code function.

Note

- r The ID can be up to 20 digits long.
- r You can enter numbers, *, #, and spaces to program an ID.
- r You can store IDs in destination lists and Programs. See p.125 "Registering and Changing Keystroke Programs". See "Registering a Fax Destination", *General Settings Guide*.
- r Messages you send using this function are marked "SID" on all reports.

SEP Code

Normally you can only use Polling Reception to receive faxes from machines that have the Polling Reception function and the same manufacturer. However, if a machine of another manufacturer supports Polling Reception, you can receive fax messages from the other party using this method instead.

You can receive messages that have the same SEP Code as the SEP Code you entered.

Note

- r The ID can be up to 20 digits long.
- r Make sure the number of digits in the ID matches the one set on the machine to which you are sending.
- r You can enter numbers, *, #, and spaces to program an ID.
- r You can store IDs in destination lists and Programs. See "Registering a Fax Destination", *General Settings Guide*. See p.125 "Registering and Changing Keystroke Programs".
- r Messages you receive using this function are marked "SEP" on all reports.
- r This function is not available with Internet Fax transmissions.

1 Dial the fax number using the number keys.

2 Press **[Adv. Features]**.



- 3 Press [SEP Code].
- 4 Press [RX SEP Code].
- 5 Enter a SEP Code, and then press [OK].



“SEP Code” appears one line above **[Adv. Features]** on the display.

Note

- r If you make a mistake, press **[Cancel]** or the **[Clear/Stop]** key before pressing **[OK]**, and then try again.

- 6 To enter a password, press **[Password (PWD)]**.
- 7 Enter the password using the number keys, and then press **[OK]**.
- 8 Press **[Exit]**.
- 9 Press **[Transmission Mode]**.

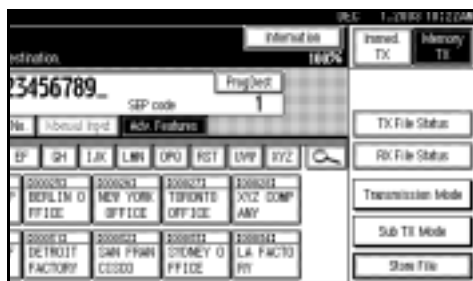

- 10 Press **[Polling RX]**.

- 11 Press **[Default ID/Free Polling RX]**, and then press **[OK]**.



[Polling RX] is highlighted, and “Deflt ID/Free Poll.” is shown.

Note

- r To cancel Polling RX, press **[Cancel]**. The display returns to that of step 10.

- 12 Press **[OK]**.

The standby display appears.

- 13 Press the **[Start]** key.

PWD Code

There are times you may want to use a password when receiving faxes by polling using the SEP Code function.

Note

- r The password can be up to 20 digits long.
- r You can enter numbers, *, #, and spaces as a password.
- r You can store IDs in destination lists and Programs. See “Registering a Fax Destination”, *General Settings Guide*. See p.125 “Registering and Changing Keystroke Programs”.
- r Messages you send using this function are marked “PWD” on all reports.

Transfer Request

Transfer Request allows fax machines that have this function to automatically transfer incoming messages to multiple fax destinations. This function helps you save costs when you send the same message to more than one place in a distant area, and saves time since many messages can be sent in a single operation.

Transfer Requests can be sent by fax or e-mail.

The diagram below may make the concept clearer.

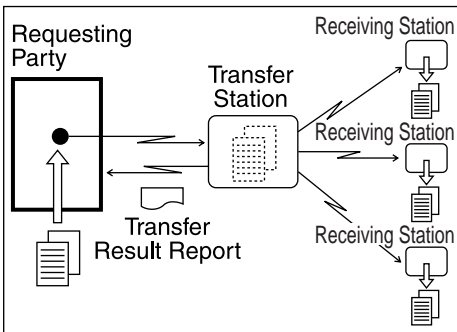

The following terminologies are used in this section:

v Requesting Party

The machine where the message originates.

v Transfer Station

The machine that forwards the incoming message to another destination.

v Receiving Station

The facsimile or computer that received the message from the Transfer Station.

📄 Preparation

Before you can use this function, you must make the following preparations:

- Program each Transfer Station number in this machine (Requesting Party) and in the Transfer Station itself. See p.181 "Transfer Report".
- Program the same Polling ID in both this machine (Requesting Party) and the Transfer Station. See p.183 "Programming a Polling ID".
- To send a Transfer Request by fax, the Transfer Station must be a fax machine of the same manufacturer and have the Transfer Station function.
- To send a Transfer Request by e-mail, Transfer Station must be a fax machine of the same manufacturer that supports Internet Fax.
- You cannot use Transfer Request without programming the fax number of the Requesting Party in a Quick Dial or Speed Dial.
- The Receiving Station's fax number must be programmed in the Transfer Station's Quick Dial, Speed Dial or Group Dial.

📌 Note

- r You can specify up to 500 Transfer Stations in a Transfer Request.
- r You can have up to 30 End Receivers per Transfer Station. If you specify a Transfer Station's Group, the Group counts as a single receiver.

- r You can specify up to 100 Receiving Stations and Transfer Stations in total.
- r When a Transfer Request is sent by e-mail, as soon as the Transfer Station completes transfer to all Receiving Stations, it sends back a Transfer Result Report by e-mail. See p.91 "Transfer Result Report (transfer request by e-mail)".
- r When a Transfer Request is sent by e-mail to a computer or facsimile without the Transfer Request function, that machine receives it as ordinary e-mail. It does not transfer the message nor send an error report back to the Requesting Party. To send Transfer Request by e-mail, use a Transfer Station that supports Internet Fax and has the Transfer Station function.
- r You can program one of the Quick Operation keys with operations for this function. Using the key allows you to omit steps **3** and **4**.

1 Place the original, and then select any scan settings you require.

Note

- r When sending a Transfer Request by e-mail, sent text size is **[Detail]**, even if **[Super Fine]** is selected.
- r Transfer Requests by e-mail are sent at A4 width. Wider originals are reduced to A4 width.

Reference

- p.15 "Placing Originals", *Facsimile Reference <Basic Features>*
- p.33 "Scan Settings", *Facsimile Reference <Basic Features>*

2 Specify a Transfer Station.

Note

- r Specify whether to enter the Transfer Station's fax number or e-mail address directly, or to use the destination list.
- r If you make a mistake, press the **[Clear/Stop]** key, and then try again.
- r When a Transfer Request is sent by e-mail, e-mail options can be set. See steps **2** and **3** on p.54 "Transmitting Internet Fax", *Facsimile Reference <Basic Features>*.

Reference

- p.38 "Entering a Fax Number", *Facsimile Reference <Basic Features>*
- p.40 "Entering an E-mail Address", *Facsimile Reference <Basic Features>*
- p.41 "Using Destination Lists", *Facsimile Reference <Basic Features>*

3 Press **[Adv. Features]**.



4 Select **[Transfer Req.]**.

5 Press **[Receiving Station]**.

6 Specify a Receiving Station.



Note

- r You cannot enter Receiving Station numbers directly. The numbers must be stored in destination lists, Speed Dial, or Groups in the Transfer Station(s). To specify a Receiving Station, use the procedure described below.
- r To cancel the Transfer Request, press **[Cancel]**. The display returns to that of step **5**.

Destination List

- A Select **[# * * Quick Dial]**.
- B Enter the registration number of the destination list where the Receiving Station is stored.
For example, to select the registration number stored in Quick Dial 01 of the Transfer Station, enter: **[0] [1]**.

Note

- r You can enter up to five digits.

Speed Dial

- A Select **[# * * Speed Dial]**.

- B Enter the number of the Speed Dial code.

For example, to select the number stored in Speed Dial 12 of the Transfer Station, enter: **[1] [2]**.

Group Dial

- A Select **[# * * Group Dial]**.
- B Enter the number of the Group number.

For example, to select the number stored in Group Dial 04 of the Transfer Station, enter: **[0] [4]**.

7 To specify another Receiving Station, press **[Add]**.

Note

- r Press **[▲ Prev.]** or **[▼ Next]** to see the Receiving Stations already entered. You can select a Receiving Station from this list and remove it by pressing **[Clear]** or the **[Clear/Stop]** key.

8 When you have specified all the Receiving Stations, press **[OK]**.

9 Press **[Exit]**.



The Transfer Stations and Receiving Stations are displayed.

10 Press the **[Start]** key.

4

With transfer requests set in the system settings

You can program a Quick Dial key with Transfer Station and/or Receiving Station using the Transfer Request function in the System Settings. See *General Settings Guide*.

- 1 Place the original down, and then select the desired settings.

Reference

p.15 "Placing Originals", *Facsimile Reference* <Basic Features>

p.33 "Scan Settings", *Facsimile Reference* <Basic Features>

- 2 Press the key programmed with Transfer Request.



- 3 Press the [Start] key.

Setting Multistep Transfer

Program a Transfer Station in a destination list. When receiving a Transfer Request that specifies the same Receiving Station as programmed in the destination list, this machine sends a Transfer Request to the programmed Transfer Station. This function allows fax messages to be transferred via multiple stations and makes fax message transfer more efficient.

You can program up to 30 Receiving Stations per Transfer Station. For more information, contact your service representative.

On Hook Dial

The On Hook Dial function allows you to dial while hearing tone from the internal speaker. You can send a fax checking the connection.

Limitation

- r This function is unavailable for the optional extra G3 interface unit.

Note

- r This function is unavailable in some countries.
- r If Transmission Result Report (Immediate Transmission) is printed, the result of a transmission with On Hook Dial is not mentioned in the report.

1 Place the original, and then select the scan settings you require.

Reference

p.15 "Placing Originals", *Facsimile Reference* <Basic Features>

p.33 "Scan Settings", *Facsimile Reference* <Basic Features>

2 Press the [On Hook Dial] key.

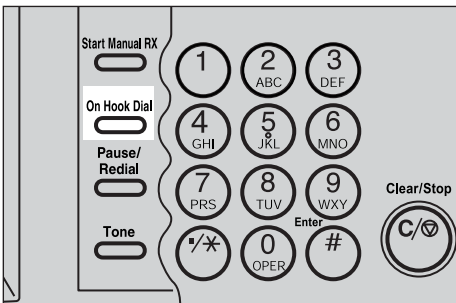

You will hear a low tone from the internal speaker.

Note

- r If you want to cancel this operation, press the [On Hook Dial] key again.

3 Dial.



The machine immediately dials the destination.

Note

- r You can adjust the volume of the On-hook sound by pressing [Higher] or [Lower] in the upper right-hand corner of the display. The volume can also be preprogrammed in "General Settings and Adjustments". See p.75 "Adjusting the Volume", *Facsimile Reference* <Basic Features> and p.142 "General Settings/Adjustment".
- r If you make a mistake, press the [On Hook Dial] or [Clear Modes] key, and then return to step 2.

4 When the line is connected and you hear a high-pitched tone, press the [Start] key.

The transmission starts.

Note

- r After transmission, the machine returns to standby mode.
- r If you want to cancel a transmission, press the [Clear/Stop] key, and then remove the originals.

 **External Telephone On Hook
Dial**

If you have an external telephone on the fax machine, you can speak with the other party when you hear a voice. If you hear a voice before pressing the **[Start]** key, pick up the external telephone and tell the receiver you want to send a fax message (ask them to switch to facsimile mode).



Manual Dial

The optional handset or external telephone is required.

Pick up the optional handset or the handset of the external telephone and dial. When the line is connected and you hear a high-pitched tone, press the **[Start]** key to send your fax message. If, on the other hand, you hear a voice at the other end, continue conversation as normal.

Limitation

- r This function is unavailable for the optional extra G3 interface unit.
- r If Transmission Result Report (Immediate Transmission) is printed, the result of a transmission with On Hook Dial is not mentioned in the report.

1 Place the original, and then select the scan settings you require.

Reference

p.15 "Placing Originals", *Facsimile Reference* <Basic Features>

p.33 "Scan Settings", *Facsimile Reference* <Basic Features>

2 Pick up the external telephone.

You will hear a tone.

3 Dial.



The machine immediately dials the destination.

Note

- r If you make a mistake, replace the external telephone, and then try again from step 2.

4 When the line is connected and you hear a high-pitched tone, press the [Start] key to send your fax message.

The transmission starts.

Note

- r If you hear a voice, tell the receiver that you want to send them a fax message (ask them to switch to facsimile mode).

5 Replace the handset of the external telephone.

After transmission, the standby display appears.

Note

- r If you want to cancel a transmission, press the **[Clear/Stop]** key, and then remove the originals.

Changing the Line Port

The optional extra G3 interface unit is required.

When the extra G3 interface unit is installed, you can connect to a maximum of three ports.

Note

- r When you install the extra G3 interface unit, you can specify the line port home position from “General Settings and Adjustment”. See p.142 “General Settings/Adjustment”.
- r When sending a fax, you can select the line port if dialing with the number keys or Chain Dial.

v G3

G3 is selected after power up or when the machine is reset. If you install the extra G3 interface unit, you can select “G3-1”, “G3-2”, “G3-3”, or “G3 Auto” depending on the number of the installed unit.



v Multi-port

When the extra G3 interface unit is installed, communications can take place simultaneously through two lines at once.

The following list shows protocol combinations available for each line type.

Option	Available line types	Available protocol combinations
Without option	PSTN	G3
Extra G3 interface unit	PSTN+PS TN	G3+G3
Extra G3 interface unit + Extra G3 interface unit	PSTN+PS TN+PSTN	G3+G3+G3

Note

- r A maximum of three communications can take place simultaneously.
- r You cannot perform three Immediate Transmissions simultaneously.
- r If three communications are in progress, the display shows the first communication that was initiated.

1 Press [Select Line].



2 Select the line you want to use.

When one optional extra G3 unit is installed.



When two optional extra G3 units are installed.

4

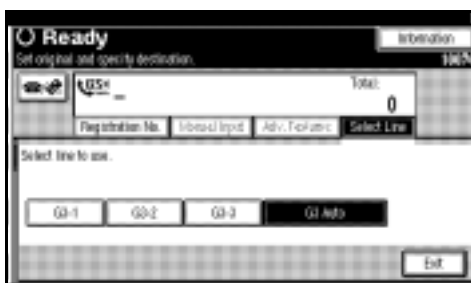

Note

r If you select "G3 Auto", the machine will use any available line. This increases efficiency.

3 Press [Exit].

The standby display appears.

Sub Transmission Mode

Book Fax

Use to send book originals from the exposure glass. Pages are scanned in the order shown below.

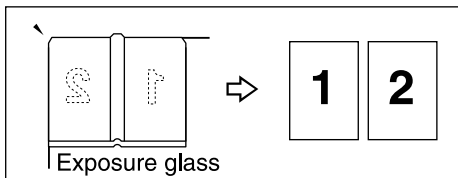

Limitation

- r Place the original on the exposure glass. You cannot use the optional ADF.
- r Depending on paper sizes available in the destination machine, the message may be reduced when printed at the other end.

Note

- r You can have bound originals scanned as left or right page first. You can set which page (left or right) the machine scans first as default with the User Parameters. See p.159 "User Parameters" (switch 06, bit 6).
- r When using the Internet Fax function, documents transmitted are sent at A4 width. Documents larger than A4 are reduced to A4 width. See p.15 "Placing Originals", *Facsimile Reference <Basic Features>*.

- 1** Place the original on the exposure glass, and then select the scan settings you require.

Reference

p.15 "Placing Originals", *Facsimile Reference <Basic Features>*

p.33 "Scan Settings", *Facsimile Reference <Basic Features>*

- 2** Press **[Sub TX Mode]**.

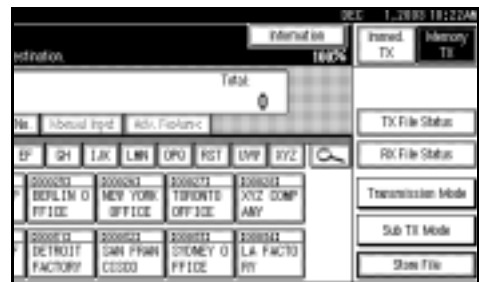

- 3** Press **[Book Fax]**.

- 4** Select the size of the original.



Note

- r To cancel this mode, press **[Cancel]**. The display returns to that of step **3**.
- r If you select A3, the original will be sent using Image Rotation Transmission. See p.79 "Transmission with Image Rotation".

5 Select **[From first Page]** or **[From second Page]**, and then press **[OK]**.

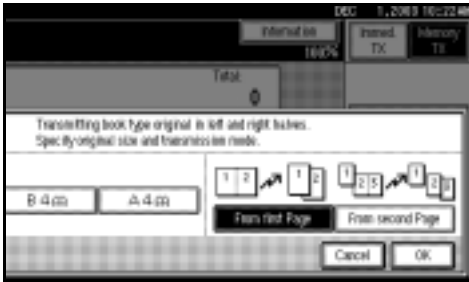

The selected original size is shown above the highlighted **[Book Fax]**.

Note

- r Select **[From first Page]** to send a book original from the first page.
- r Select **[From second Page]** if you want to send a cover letter as the first page.
- r To cancel this mode, press **[Cancel]**. The display returns to that of step **3**.

6 Press **[OK]**.

7 Specify a destination, and then press the **[Start]** key.

Note

- r When sending more than one page, place the originals individually, one after the other, pressing the **[Start]** key after each page.
- r After the last original has been scanned, press **[#]**.
- r If **[#]** is not pressed, the machine will automatically start sending the documents, 60 seconds after the last original has been scanned.

Two-Sided Transmission (Double-Sided Transmission)

The optional ADF is required.

Use this function to send two-sided originals.

Note

- r Originals placed on the exposure glass cannot be sent.
- r The front and back of the scanned original will be printed in order on separate sheets at the other end. The orientation of alternate sheets may be reversed at the other end. If you want to print the original with the same orientation at the other end, specify the "Original Position" and "Page Opening Orientation".

	Original	Original position	Page opening orientation	Output at the other end
A3, B4, JIS, A4, 11" x 17", 8 1/2" x 14", 8 1/2" x 11"			Top to Top	
			Top to Bottom	
			Top to Top	
			Top to Bottom	
B5, JIS, A5, 8 1/2" x 5 1/2"			Top to Top	
			Top to Bottom	
			Top to Top	
			Top to Bottom	

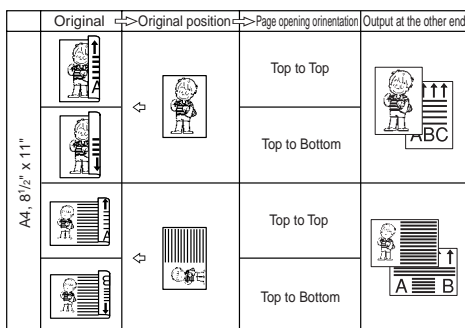

p.79 "Transmission with Image Rotation"

- r This function is only available with Memory Transmission.
- r This function is only available with the ADF.
- r You can confirm whether both sides were properly scanned using the Stamp function. See p.72 "Stamp".
- r You can program one of the Quick Operation keys with operations for this function. Using the key allows you to omit steps **2** and **3**.

- 1** Place the original in the ADF, and then select the scan settings you require.

Reference

- p.15 "Placing Originals", *Facsimile Reference* <Basic Features>
- p.33 "Scan Settings", *Facsimile Reference* <Basic Features>

- 2** Press [Sub TX Mode].

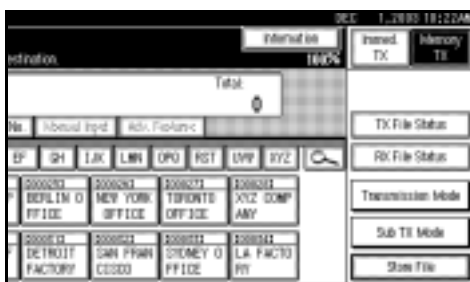

- 3** Press [2 Sided Original].

- 4** Specify the original position.

Check the orientation of the placed document, and then press or .

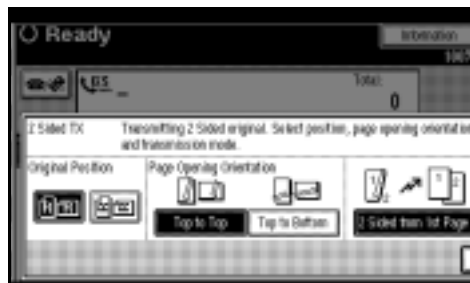

Note

- r Make sure that the specified original position matches the orientation of originals loaded in the ADF.

- 5** Specify the page opening orientation from [Top to Top] or [Top to Bottom].

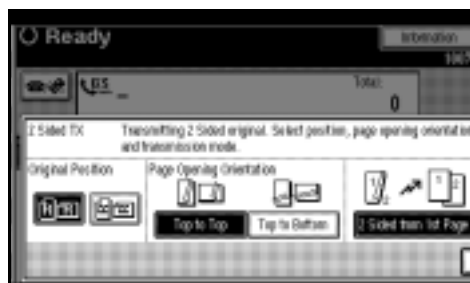

- 6** Specify the transmission mode from [2 Sided from 1st Page] or [1 Sided for 1st Page], and then press [OK].

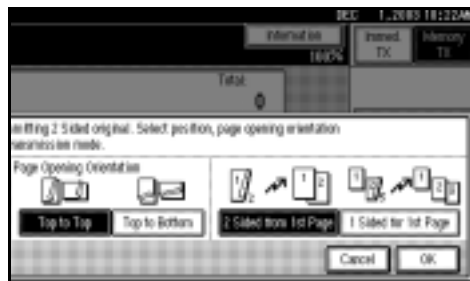

The selected original position and page opening orientation are shown above the highlighted **[2 Sided Original]**.

Note

- r To cancel this mode, press **[Cancel]**. The display returns to that of step **3**.
- r Select **[2 Sided from 1st Page]** to send a two-sided original from the first page.
- r Select **[1 Sided for 1st Page]** if you want to send a cover letter as the first page.

7 Press **[OK]**.

8 Specify the destination, and then press the **[Start]** key.

Standard Message Stamp

Use this function to stamp a standard message at the top of the first original sent.

There are four types of standard messages: “Confidential”, “Urgent”, “Please phone”, and “Copy to corres. section”

You can also program other messages.

Note

- r While this function is in use, the third line of the Label Insertion is not printed. See p.76 “Programming the Label Insertion”.
- r When there is an image around the area where the standard message is to be stamped, that image is deleted.
- r To program a standard message, use the Program/Change/Delete Standard Message function. See p.149 “Programming, Changing, and Deleting Standard Messages”.

1 Place the originals, and select the scan settings you require.

Reference

- p.15 “Placing Originals”, *Facsimile Reference <Basic Features>*
- p.33 “Scan Settings”, *Facsimile Reference <Basic Features>*

2 Press **[Sub TX Mode]**.

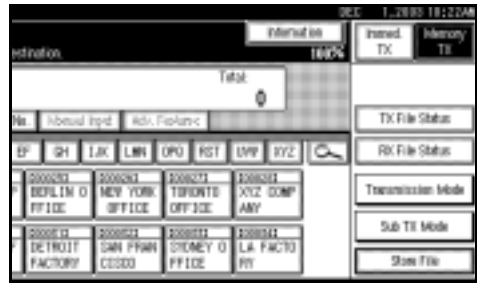

3 Press **[Std. Message]**.

4 Select the standard message to be stamped, and then press **[OK]**.

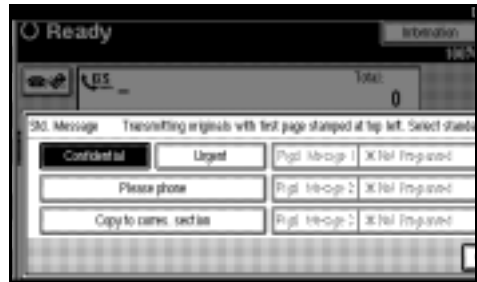

The selected standard message is shown above the highlighted **[Std. Message]**.

Note

- r To cancel the selection, press **[Cancel]**. The display returns to that of step **3**.
- r Programmed standard messages are shown in the keys.
- r The machine cannot stamp multiple standard messages.

5 Press **[OK]**.

- 6** Specify the destination, and then press the **[Start]** key.

Sending an Auto Document

If you often send a particular page to people (for example a map, a standard attachment, or a set of instructions), store that page in memory as an Auto Document. This saves rescanning every time you want to send it.

You can fax an Auto Document by itself, or attach it to a normal fax message.

Preparation

You need to register an Auto Document. See p.150 “Storing, Changing, and Deleting an Auto Document”.

Note

- r You can attach one Auto Document to each transmission.
- r You can store up to 6 Auto Documents (up to 18 with the optional expansion memory installed). See p.150 “Storing, Changing, and Deleting an Auto Document”.
- r Files with Auto Documents are sent by Memory Transmission.
- r When sending an Auto Document with other files, the Auto Document is sent first.
- r Storing Auto Documents reduces the amount of free memory slightly. Unless you delete the document, free memory will not return to 100%.
- r You can print an Auto Document currently stored in memory. See p.66 “Printing documents stored as Auto Documents”.
- r You can program one of the Quick Operation keys with operations for this function. Using the key allows you to omit steps **2** and **3**.

- 1** Place the original, and then select the scan settings you require.

Reference

p.15 “Placing Originals”, *Facsimile Reference* <Basic Features>

p.33 “Scan Settings”, *Facsimile Reference* <Basic Features>

Note

- r When you fax an Auto Document, start from step **2**.

- 2** Press **[Sub TX Mode]**.

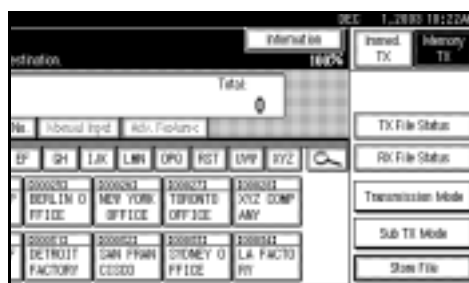

- 3** Press **[Auto Document]**.

- 4** Select an Auto Document file, and then press **[OK]**.

When you fax an Auto Document by itself, press **[TX Stored File(AD) Only]**, and then press **[OK]**.

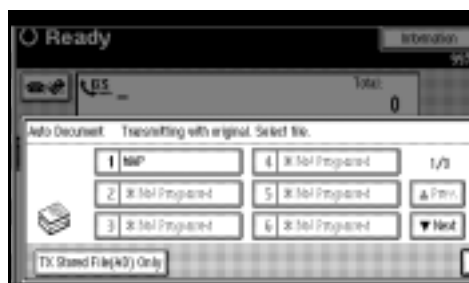

The selected file name is shown above the highlighted **[Auto Document]**.

Note

- r Programmed Auto Documents are shown in the keys.
- r To cancel the Auto Document, press **[Cancel]**. The display returns to that of step **3**.

5 Press **[OK]**.

6 Specify the destination, and then press the **[Start]** key.

Printing documents stored as Auto Documents

This function is used for printing documents stored as Auto Documents. This function is very convenient as it can be used for checking the contents of stored files.

1 Press **[Sub TX Mode]**.

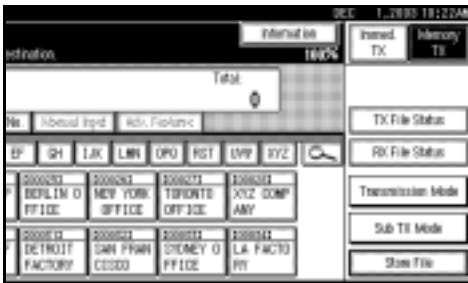

2 Press **[Auto Document]**.

3 Select an Auto Document file to be printed, and then press **[Print File]**.

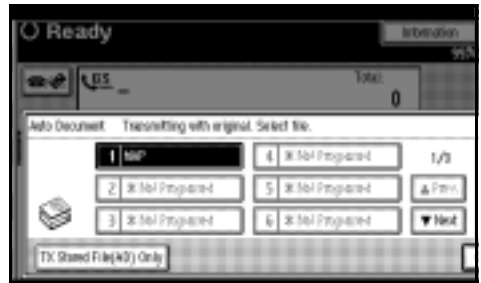

Note

- r To cancel the Auto Document, press **[Cancel]**. The display returns to that of step **2**.

4 Press the **[Start]** key.

Once printing is completed, the display returns to that of step **3**.

Note

- r To cancel printing after pressing the **[Start]** key, press **[Stop Printing]**. The display returns to that of step **3**.

5 Press **[Cancel]**.

Note

- r You can also send Auto Documents. See p.65 "Sending an Auto Document".

6 Press **[OK]**.

The standby display appears.

Sending a Stored File

Use this function to send documents stored in the Document Server. You can specify and send multiple documents, and also send them with scanned originals all at once.

You can also print stored originals with **[Print File]**. See p.70 “Printing stored documents”.

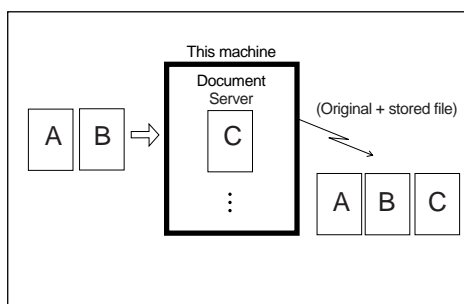

Preparation

Store the documents to be sent in advance. You can program a password for this function. You can change the user names, file names, and passwords of stored documents. See p.129 “Using the Document Server”, and p.132 “Changing Information of Stored Documents”.

Note

- r Received fax documents are stored and categorized as stored reception files. See p.34 “Printing/Deleting Received and Stored Documents (Print Stored RX File)”.
- r You can program one of the Quick Operation keys with operations for this function. Using the key allows you to omit steps **1** and **2**.

Sending stored documents

The machine sends documents stored in the Document Server.

The documents stored in the Document Server can be sent again and again until they are deleted. Once sent, documents are stored in the Document Server. Therefore, you can send them in just one operation without having to set your originals again.

Limitation

- r You cannot use the following transmission methods:
 - Free Polling Transmission
 - Default ID Transmission
 - ID Override Transmission
 - Immediate Transmission
 - Parallel Memory Transmission
 - On Hook Dial
 - Manual Dial

Note

- r You can specify and print multiple documents. You can specify a maximum of 30 documents at once.
- r The machine can send a total of 1,000 pages in one operation.
- r The specified documents are sent with the scan settings made when they were stored.

1 Press **[Sub TX Mode]**.

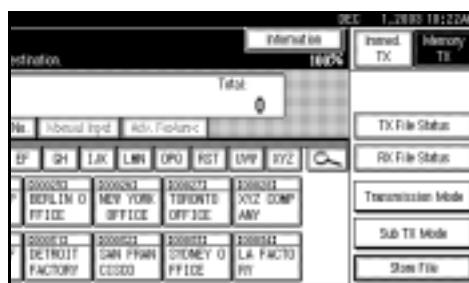

2 Press **[Select Stored File]**.

3 Select the documents to be sent.



Note

- r When multiple documents are selected, they are sent in the order of selection.
- r Press **[TX Order]** to arrange the order of the documents to be sent.
- r Press **[File Name]** to place the documents in alphabetical order.
- r Press **[User Name]** to place the documents in order by programmed user name.
- r Press **[Date]** to place the documents in order of programmed date.

Specifying documents from the file list

- A Press **[▲ Prev.]** or **[▼ Next]** to display the documents to be sent.
- B Select the file name.

Specifying documents from the User Name

A Select **[Search by User Name]**.



B Select the user name of the programmed document, and then press **[OK]**.



Note

- r To search by user name, press **[Non-programmed Name]**, and then enter the user name. Partial matching is used when searching for a user name. See p.163 "Special Senders to Treat Differently".

C Select the file name to be sent.

Specifying documents from the file name

A Select [Search by File Name].



B Enter the name of the document to be sent, and then press [OK].

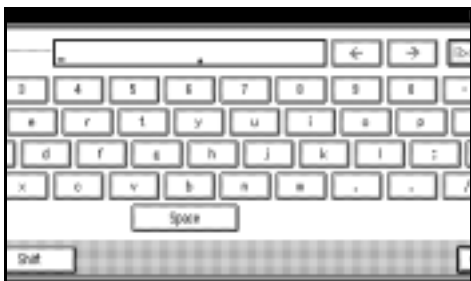

Note

r Partial matching is used when searching for a file name. See p.163 "Special Senders to Treat Differently"

C Select the file name to be sent.

4 If you select a document with a password, enter the password, and then press [OK].



If the document does not have a password, proceed to step **5**.

5 When you want to add your originals to stored documents and send them all at once, press [Orig. + Stored File] or [Stored file + Orig.].



When sending only stored documents, proceed to step **6**.

Note

- r When [Orig. + Stored File] is pressed, the machine sends the originals and then stored files. When [Stored file + Orig.] is pressed, the machine sends the stored files and then originals.
- r The added originals are not stored.

6 Press [OK] twice.

Note

- r To add an original to stored documents, place the original, and then select any scan settings you require.

7 Specify the destination, and then press the [Start] key.

Printing stored documents

Use this function to print documents stored in the Document Server.

Note

- r Only documents stored using the facsimile function can be printed.
- r You can print documents saved from the copy or the printer function with the Document Server. You cannot print documents saved from the scanner function with this mode.
- r You can also print the first page only to check the content of the original.
- r You can specify and print multiple documents. You can specify a maximum of 30 documents at one time.

1 Press [Sub TX Mode].

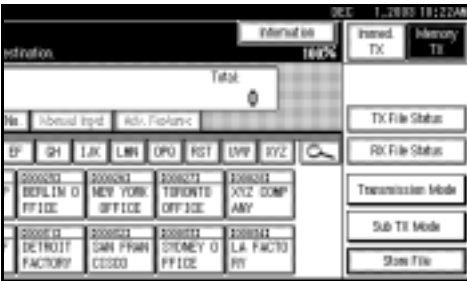

2 Press [Select Stored File].

3 Select the document to be printed.



Note

- r The documents stored using the facsimile function appear on the display.
- r Press [File Name] to place the documents in alphabetical order.
- r Press [User Name] to place documents in order of programmed user name.
- r Press [Date] to place the documents in order by the programmed date.
- r To see details of the selected document, press [Detail]. To return to the standby menu, press [Select File].



Selecting a document from file list

A Press [▲ Prev.] or [▼ Next] to display the document to be sent.

B Select the file name.

Specifying a document from the User Name

A Select [Search by User Name].



B Press the user name of the document to be sent, and then press [OK].



Note

To search by user name, press **[Non-programmed Name]**, and then enter the user name. User name searches using partial matching.

Reference

“Entering Text”, *General Settings Guide*

C Select the file name.

Specifying a document from the file name

A Press [Search by File Name].



B Enter the file name to be printed, and then press [OK].



Note

Partial matching is used to search for the file name.

Reference

“Entering Text”, *General Settings Guide*

C Select the file name.

4 If you select a document with a password, enter the password, and then press [OK].



If the document does not have a password, proceed to step **5**.

5 Press **[Print File]** or **[Print 1st Page]**.

When **[Print File]** is pressed, the machine prints all the pages. When **[Print 1st Page]** is pressed, the machine prints only the first page.

Limitation

- r When **[Print 1st Page]** is selected, originals larger than A4 size are printed after they are reduced to A4 size.
- r The machine can print up to 30 files using the Print 1st Page function.

Note

- r To print both sides, press **[Print 2 Sides]**.
- r To cancel printing, press **[Cancel]**.

6 Press the **[Start]** key.**Note**

- r When only the first page is printed, the file name is printed at the top of the paper.
- r To cancel printing after pressing the **[Start]** key, press **[Stop Printing]**.

7 Press **[OK]** twice.

The standby display appears.

Stamp

The optional ADF is required.

When sending a fax message using the ADF, the machine can stamp a circle mark at the bottom of the original. When sending a two-sided document, the document is marked at the bottom of the front page and top of the rear page. This stamp indicates that the original has been successfully stored in memory for Memory Transmission, or successfully sent by Immediate Transmission.

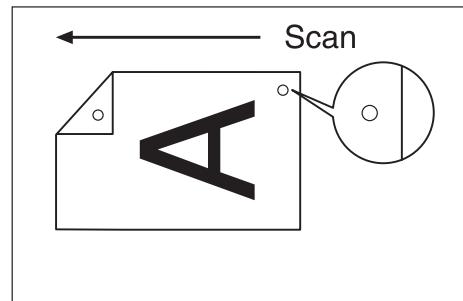
**Note**

- r Stamp only works when scanning from the ADF.
- r When the stamp starts getting lighter, replace the cartridge. See p.191 "Replacing the Stamp Cartridge".
- r If a page was not stamped even though the Stamp function is turned on, you need to resend that page.
- r If you use this function often, you can set the default in General Settings and Adjustment so that this function is always on. In this case, Stamp can easily be turned off for any single transmission by pressing **[Stamp]**. See p.142 "General Settings/Adjustment".

- r A paper jam during Parallel Memory Transmission may cause the transmission to be failed even if stamping is performed.
- r You cannot turn the Stamp function on or off while a document is being scanned.

1 Place the original, and then select the scan settings you require.

Reference

p.15 "Placing Originals", *Facsimile Reference* <Basic Features>

p.33 "Scan Settings", *Facsimile Reference* <Basic Features>

2 Press [Sub TX Mode].

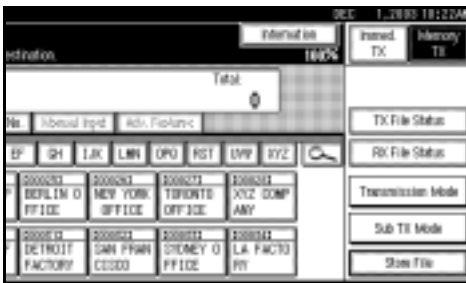

3 Press [Stamp], and then press [OK].

Note

- r To cancel the stamp, press [Stamp] again before pressing [OK].

4 Specify the destination, and then press the [Start] key.

Transmission Options

This section describes various functions that you can switch on and off for any particular transmission, following the procedures given here.

In addition, if you frequently use a certain option configuration, you can change the default home position (on or off) of each option.

Fax Header Print

In some cases, you may want the other party to receive an unmarked copy of your original. To do this, switch Fax Header off.

When the Fax Header is set to "ON", the stored name is printed on the receiver's paper.

You can store two Fax Headers; "First Name" and "Second Name".

For example, if you store your department name in one and your organization name in the other, you could use the first when sending internal faxes and the second for external faxes.

Note

- r If you used the number keys to specify the receiver, the first header name will be printed on the receiver's paper.
- r You can program fax header names using the Program Fax Information function.
- r You can select whether or not dates, fax header names, file numbers, or page numbers are printed by changing their respective User Parameters. (switch 18, bit 3, 2, 1, 0) See p.159 "User Parameters".
- r You can program one of the Quick Operation keys with operations for this function.

Label Insertion

With this function you can have the receiver name printed on the message when it is received at the other end. The name will be printed at the top of the page and will be preceded by "To". You can also cause the text programmed as a standard message to be printed. See p.149 "Programming, Changing, and Deleting Standard Messages".

 **Note**

- r When there is an image around the area where the Label is to be printed, that image is deleted.
- r You can program one of the Quick Operation keys with operations for this function.

Sender Stamp

When there is data, such as the user name and department name, programmed into the user code, you can have the machine print a sender stamp on the right edge of your paper.

 **Note**

- r Enter the user name in System Settings.

Reduced Image Transmission

Using this function, your message is sent at a reduced size (93%) with a blank margin on the left.

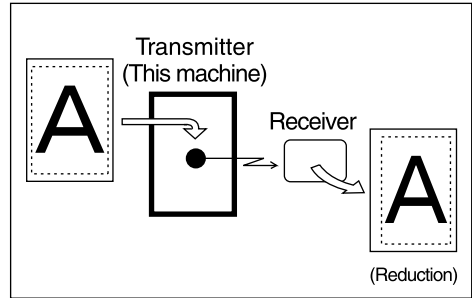

 **Note**

- r This function is unavailable with Immediate Transmission, or specified transmission of a stored document.
- r Image Rotation is unavailable with this function.

Auto Reduce

When this function is turned on, if the receiver's paper is smaller than the paper you are sending on, the message is automatically reduced to fit onto the paper available at the other end.

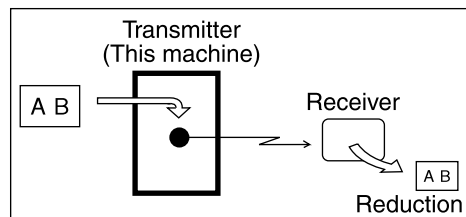

Important

- If you turn this function off, the scale of the original is maintained and some parts of the image may be deleted when printed at the other end.

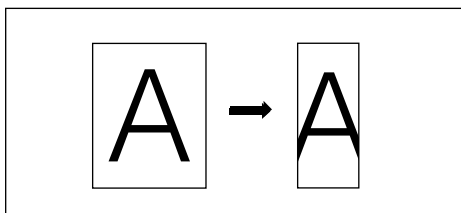

Default ID Transmission

If you turn this function on, transmission will only take place if the destination's Polling ID is the same as yours. This function can stop you accidentally sending information to the wrong place (you need to coordinate Polling ID's with the other party).

Note

- You can program one of the Quick Operation keys with operations for this function.

Selecting transmission options for a single transmission

- Place the original, and then select the scan settings you require.

Reference

p.15 "Placing Originals", *Facsimile Reference* <Basic Features>

p.33 "Scan Settings", *Facsimile Reference* <Basic Features>

- Press [Sub TX Mode].

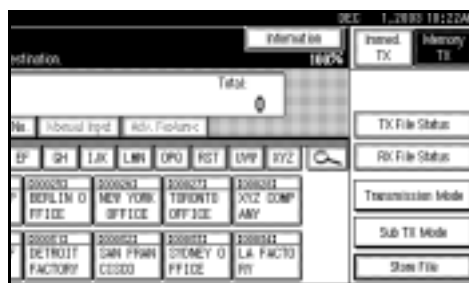

- Select [Options].

- Select options to be set up.

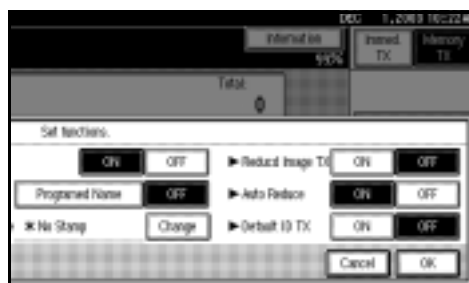
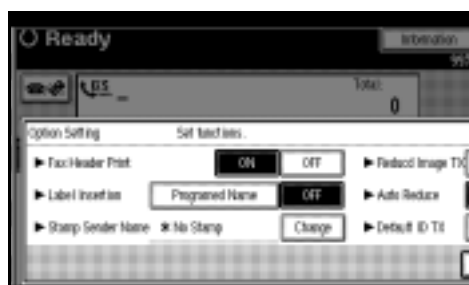

Note

- To close the option settings, proceed to step 5.

Programming the Fax Header Print

- Press [ON] for Fax Header Print.

Note

- Press [OFF] if you do not want to print the sender name.

Programming the Label Insertion

A Press **[Programed Name]** for Label Insertion.

 **Note**

- r Press **[OFF]** if you do not want to insert a destination.

Programming the Stamp Sender Name

A Press **[Change]** for Stamp Sender Name.

B Press the name of the user to be stamped, and then press **[OK]**.



 **Note**

- r The set user name is displayed when the user code has been stored. See *General Settings Guide*.
- r You can switch titles by pressing the title keys.
- r To stamp a non-programmed user name, press **[Non-programmed Name]**, and then enter the user name.
- r If you do not want to stamp the sender's stamp, press **[*Do not Stamp]**.

Programming the Reduced Image Transmission

A Press **[ON]** in for Reduced Image TX.

 **Note**

- r Press **[OFF]** if you do not want to do a reduced transmission.

Programming the Auto Reduce

A Press **[ON]** for Auto Reduce.

 **Note**

- r Press **[OFF]** if you do not want to use the Auto Reduce function.

Programming the Default ID Transmission

A Press **[ON]** for Default ID TX.

 **Note**

- r Press **[OFF]** if you do not want to use ID transmission.

5 Press **[OK]** twice.

6 Specify the destination, and then press the **[Start]** key.

More Transmission Functions

If Memory Runs Out While Storing an Original

If you run out of memory while storing an original (free space reaches 0%), the message "Memory is full. Cannot scan more. Transmission will be stopped." is displayed.

Press **[Exit]** to transmit stored pages only.

Note

- r In default, scanned pages are sent. To change the settings to delete scanned pages, contact your service representative.

Parallel Memory Transmission

This function dials while the original is being scanned. Standard Memory Transmission stores the original in memory, then dials the destination. Parallel Memory Transmission allows you to quickly determine whether a connection was made. In addition, this function scans the original faster than Immediate Transmission. This is useful when you are in a hurry and need to use the original for another purpose.

Limitation

- r Standard Memory Transmission is used instead of Parallel Memory Transmission in the following cases:
 - When the line is busy and could not be connected to
 - With Send Later

- When you store an original for Memory Transmission while another communication is in progress
- When two or more destinations are specified
- When you send only an Auto Document
- When the first page of an original is placed on the exposure glass
- When you send messages stored in the Document Server

Note

- r You can turn this function on or off with the User Parameters. See p.159 "User Parameters" (switch 07, bit 2).
- r Standard Memory Transmission may be used instead of Parallel Memory Transmission depending on the optional equipment installed if there is not enough free memory left.
- r If you use this function, the Memory Storage Report will not be printed.
- r If the **[Clear/Stop]** key is pressed, an original will jam or memory will run out during Parallel Memory Transmission stops. The Transmission Result Report is printed and files are deleted.
- r When Parallel Memory Transmission is used, the total number of originals in "Fax Header Print" is not automatically printed.

Checking the Transmission Result

- Turn the Transmission Result Report on if you want a report to be printed after every successful transmission. See p.82 “Transmission Result Report (Memory Transmission)”.
- If you leave the Transmission Result Report off, the report will not be printed after every transmission. However, if a transmission fails, a Communication Failure Report will be printed instead. See p.83 “Communication Failure Report”.
- You can also check the transmission result by examining the Journal. See p.27 “Printing the Journal”.
- You can either print or scroll through the Journal on the display. See p.31 “Checking the Transmission Result (TX File Status)”.

Automatic Redial

If a fax message could not be transmitted because the line was busy or an error occurred during transmission, redialing is done five times in five minutes intervals (these figures vary according to which country you are in).

If redialing fails after four redials, the machine cancels the transmission and prints a Transmission Result Report or Communication Failure Report. See p.83 “Communication Failure Report”. and p.82 “Transmission Result Report (Memory Transmission)”.

Batch Transmission

If you send a fax message by Memory Transmission and there is another fax message waiting in memory to be sent to the same destination, that message is sent along with your original. Several fax messages can be sent with a single call, thus eliminating the need for several separate calls. This helps save communication costs and reduce transmission time.

Fax messages for which the transmission time has been set in advance are sent by batch transmission when that time is reached.

Note

- r You can turn this function on or off with the User Parameters. See p.159 “User Parameters” (switch 14, bit 2).
- r The originals to be transmitted at a specific time will be sent at that time.
- r If fax memory is overloaded, messages may not be sent in the order they were scanned.

ECM (Error Correction Mode)

This function automatically sends data that was not transmitted successfully using a system that complies with international standards.

ECM requires that the destination machine has the same function.

Note

- r You can turn this function on or off using the Key Operator Settings. See p.158 “ECM”.



Dual Access

The machine can scan other messages into memory even while sending a fax message from memory, receiving a message into memory, or automatically printing a report. Since the machine starts sending the second message immediately after the current transmission ends, the line is used efficiently.

Note

r Note that during Immediate Transmission or when in User Tools mode, the machine cannot scan an original.

Transmission with Image Rotation

Generally, place A4, 8¹/₂"×11" originals in the landscape orientation () . If you place an A4, 8¹/₂"×11" original in the portrait orientation () , the image will be sent rotated by 90°. Providing the receiver has A4, 8¹/₂"×11" landscape paper () , the message will be printed the same size as the original.

Note

- r This function is unavailable with Immediate Transmission.
- r When Image Rotation is used, all messages are sent by normal Memory Transmission.
- r This function is unavailable when using Mixed Original Sizes.

Simultaneous Broadcast

The optional extra G3 interface unit is required.

The Standard Broadcast function sends faxes one at a time to multiple destinations in the order of specified destinations.

The Simultaneous Broadcast function, however, can simultaneously send faxes to three destinations using different lines.

This results in a shorter overall transmission time.

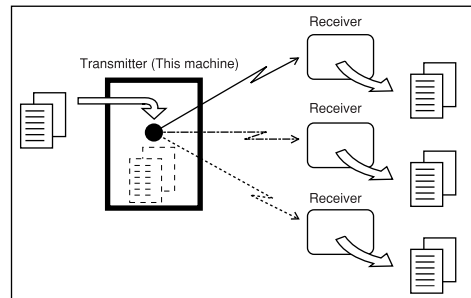

Note

- r This function can use a maximum of three lines simultaneously.
- r When using the optional extra G3 interface unit, if you set the line selection as "G3 Auto" beforehand, the machine will use whichever G3 line is not busy. This increases efficiency.

JBIG Transmission

The optional fax function upgrade unit is required.

If you use JBIG (Joint Bi-level Image Experts Group) compression, you can send photographic originals faster than with other methods of compression. You can only use this function with G3 line type.

Reference

p.34 "Original Type", *Facsimile Reference* <Basic Features>

Limitation

- r This function requires that the other party's fax machine has both the JBIG function and ECM function (G3 communication only).
- r Unavailable when using Internet Fax.

Note

- r When the optional extra G3 interface unit is installed, JBIG receptions of G3-2 and G3-3 lines are standard.
- r If ECM is turned off, JBIG Transmission is unavailable. See p.158 "ECM".

Transmitting Journal by E-mail

Preparation

To transmit the Journal by e-mail, it is necessary to make settings with User Parameters. See p.159 "User Parameters" (switch 21, bit 4).

The Journal is automatically transmitted to an e-mail address of the administrator by every 50 communications. A CSV format Journal is attached to the e-mail. See "Settings You Can Change with User Tools - File Transfer", *Network Guide*.

Important

- r This machine does not store sent CSV files. It is recommended that you double-check the e-mail address of an administrator before the Journal is transmitted. If the e-mail address of the administrator is not correct, your important Journal may be lost and sent CSV file is not left on the fax machine.

Note

- r If the administrator address is wrong, you may not be able to acquire Journal.
- r If the Journal in e-mail format fails to be transmitted, the Journal is printed out.
- r The name of an attached CSV file is "JOURNAL+year, month, hours, minutes". For example, the file name transmitted in 10:40:12 on 30th, September, 2003 is "JOURNAL20030930104012.csv".
- r The subject of Journal by e-mail begins with "Journal".

Journal by E-mail

If the setting is made so that the Journal is transmitted as e-mail, it is transmitted to the e-mail address of an administrator.

This section describes the CSV format of the Journal attached with e-mail.

Note

- r To transmit the Journal, it is necessary to make settings with User Parameters. See p.159 "User Parameters" (switch 21, bit 4).
- r To set the administrator e-mail address, see "Settings You Can Change with User Tools - File Transfer", *Network Guide*.

Printed Report

Memory Storage Report

This report is printed after an original is stored in memory. It helps you review the contents and the destinations of stored originals.

 **Limitation**

- r If you use Parallel Memory Transmission, the Memory Storage Report is not printed.

 **Note**

- r You can turn this report on and off. See p.159 “User Parameters” (switch 03, bit 2).
- r Even if the machine is set up not to print this report, it is still printed if an original could not be stored.
- r You can select whether to include part of the original image on the report. See p.159 “User Parameters” (switch 04, bit 7).

Transmission Result Report (Memory Transmission)

This report is printed when a Memory Transmission is completed, so you can check the result of the transmission. If E-mail TX Results is programmed in a Quick Operation key, you can select whether a report e-mail is sent after transmission.

 **Note**

- r If two or more destinations are specified, this report is printed after the fax message has been sent to all the destinations.
- r If the machine is set up not to print this report and the fax message could not be successfully transmitted, a Communication Failure Report is printed. See p.83 “Communication Failure Report”.
- r You can turn this function on or off with the User Parameters. See p.159 “User Parameters” (switch 03, bit 0).
- r You can select whether to include part of the original image on the report. See p.159 “User Parameters” (switch 04, bit 7).
- r To view the report without text disruption, select a font of even character width in your e-mail application's settings.
- r The Page column gives the total number of pages. The Not Sent column gives the number of pages that could not be sent successfully.
- r -- column indicates the Internet Fax was sent to the mail server programmed in this machine. (However, this does not mean the e-mail was delivered.)

Communication Failure Report

This report is printed when a message could not be successfully transmitted with Memory Transmission.

If the machine is set up to print a Transmission Result Report, this report is not printed. Use it to keep a record of failed transmissions so you can send them again.

Note

- r This report is only printed if the Transmission Result Report is turned off and a message could not be successfully transmitted with Memory Transmission.
- r You can select whether to include part of the original image on the report. See p.159 "User Parameters" (switch 04, bit 7).
- r The Page column gives the total number of pages. The Not Sent column gives the number of pages that could not be sent successfully.
- r Unprogrammed destination column indicates the message could not be sent because the transfer's fax number is incorrect, or not programmed.
- r -- column indicates the Internet Fax was sent to the mail server programmed in this machine. (However, this does not mean the e-mail was delivered.)

Transmission Result Report (Immediate Transmission)

If you turn this report on, a report will be printed after every Immediate Transmission so you have a record of whether the transmission was successful or not. If the machine is set up not to print this report and the fax message could not be successfully transmitted, the Error Report is printed instead. If E-mail TX Results is programmed in a Quick Operation key, you can select whether a report e-mail is sent after transmission.

Note

- r You can switch this report on or off in the User Parameters. See p.159 "User Parameters" (switch 03, bit 5).
- r To view the report without text Disruption, select a font of even character width in your e-mail application's settings.
- r If the page was sent successfully, the Page column gives the total number of pages sent successfully.

5. Reception Features

Reception

Immediate Reception

Each page of a fax message is printed as soon as it is received. This method is used for standard fax messages.

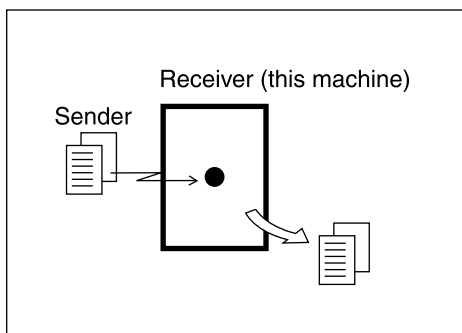

Normally this machine receives messages by Immediate Reception. But Memory Reception is used when "Combine 2 Originals", "Multi-copy Reception", "RX Reverse Printing" or "2 Sided Print" is set to "ON". See p.96 "Printing Options". If the conditions are that Substitute Reception should be used, a fax message is not printed. It will be stored in memory. See p.85 "Memory Reception". See p.86 "Substitute Reception".

Note

- r The machine may not be able to receive fax messages when free memory space is low.
- r If free memory reaches 0% during Immediate Reception, any further reception becomes impossible and the current communication is terminated.

v Reception resolution

This machine supports Standard, Detail, and Super Fine resolutions for reception. If you do not have the optional fax function upgrade unit, faxes sent at Super Fine resolution will be printed on your machine at Detail resolution. This may differ from the sender's intended resolution. See p.33 "Resolution", *Facsimile Reference* <Basic Features>.

Memory Reception

The machine waits until all pages of the message have been received into memory before printing it.

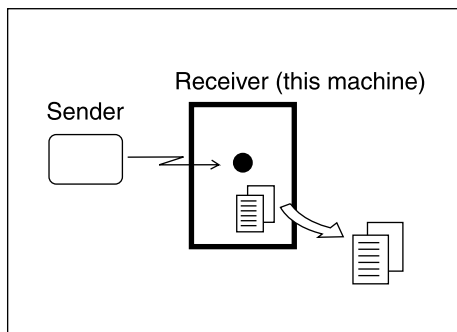

This method is used with the following functions:

- Combine 2 originals
See p.99 "Combine Two Originals".
- Multi-copy when set to multiple copies
See p.98 "Multi-copy Reception".
- Reverse Order Printing
See p.100 "Reverse Order Printing".
- 2-sided Printing
See p.97 "Two-Sided Printing".

Important

- r When about one hour passes after power of the machine is turned off, all fax messages stored in memory will be lost. If any messages have been lost for this reason, a Power Failure Report is automatically printed when the operation switch is turned on. Use this report to identify lost messages.
- r The machine may not be able to receive large numbers of messages or messages with high data content. In such cases, we recommend you switch off the above functions or install the optional expansion memory.

Limitation

- r The machine may not be able to receive fax messages when free memory space is low.

Note

- r If the free memory space reaches 0% during Memory Reception, the machine can no longer receive the current fax message and stops communicating.
- r If you have selected Store for Reception File Setting, received messages will be saved on the hard disk and will not be printed. You can print those messages by operating the machine or a connected computer, as necessary. See p.184 “Storing or Printing Received Documents”.

5

Substitute Reception

In Substitute Reception, a received fax message is stored in memory instead of being printed. Substitute Reception gets used when the machine cannot print any fax messages. Fax messages received using Substitute Reception are automatically printed when the condition which caused the machine to use Substitute Reception is rectified.

Depending on why the machine cannot print, Substitute Reception might be used for all fax messages received, or for only those messages that match a specified condition.

The Receive File indicator lights to let you know when fax messages have been received using Substitute Reception.

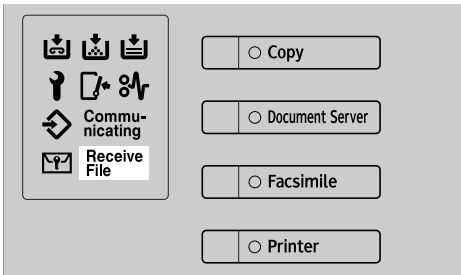



Note

- r Reception may not take place if there is not enough free memory.
- r If free memory reaches 0% during Substitute Reception, any further reception becomes impossible and the current communication is terminated.
- r When a fax message is received after Store has been selected for Reception File Setting in the Facsimile Features menu, the Receive File indicator lights.





Receiving messages unconditionally

If one of the conditions listed below occurs, the machine receives all fax messages using Substitute Reception.

Problems	Causes	Solutions
 is lit.	Paper is jammed.	Remove the jammed paper. See "  Cleaning Misfeeds", <i>General Settings Guide</i> .
The machine is printing with other function.	The machine is busy printing with other function.	The message will be automatically printed after the current job finishes.
The message "Following output tray is full. Remove paper." appears.	The output tray is full.	Remove paper from the output tray.
 is lit.	The cover is open.	Close the cover shown in the display.

Receiving messages according to parameter-specified settings

If one of the conditions listed below occurs, the machine receives only those messages that match the conditions specified in the User Parameters. See p.159 "User Parameters" (switch 05, bit 2,1).

Problems	Causes	Solutions
 is lit.	All trays out of paper.	Add paper. See "  Loading Paper", <i>General Settings Guide</i> .
 is lit.	Toner is empty.	Replace the toner cartridge. See "  Adding Toner", <i>General Settings Guide</i> .
The message "This tray is out of order." appears.	All trays out of action.	Call your service representative.

You can specify the following conditions with the User Parameters. See p.159 "User Parameters" (switch 05, bit 2,1).

v **When Own Name or Own Fax Number is received**

The machine switches to Substitute Reception only when the sender has programmed their Own Name or Own Fax Number. If the power is switched off for more than an hour, all the messages stored in memory are deleted. In that case, the Power Failure Report or the Journal can be used to identify which messages are lost so you can ask the senders to transmit them again.

 **Important**

r If a sender has not programmed their Own Name or Own Fax Number, the machine may fail to receive an important fax message. We recommend that you ask important senders to program an Own Name or Own Fax Number in advance.

v **Free**

The machine switches to Substitute Reception regardless of whether or not the sender has programmed their Own Name or Own Fax Number.

v **Polling ID match**

The machine switches to Substitute Reception only when the programmed Polling ID of the other end matches the ID of this machine.

v **Disable**

The machine does not receive any messages.

Reception Functions

Transfer Station

Transfer Stations allow you to expand the standard functions of your fax machine to set up complex networks.

The diagram below may make the concept clearer.

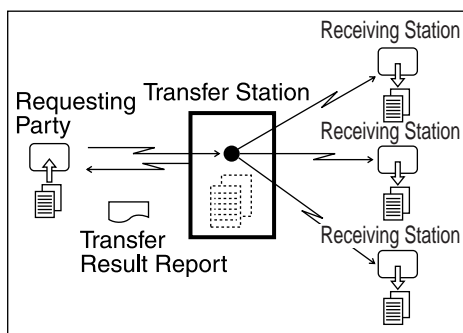

The following terminologies are used in this section:

v Requesting Party

The machine where the message originates.

v Transfer Station (this machine)

The machine that forwards the incoming message to another destination.

v Receiving Station

The facsimile or computer that received the message from the Transfer Station.

The final destination of the message, that is the machine the Transfer Station sends to. Receiving Stations must be programmed into a Quick Dial or Groups in the Transfer Station.

📁 Preparation

This machine can receive forwarding requests by e-mail. Before you can use this function, you must make the following preparations.

- Program each Transfer Station number in this machine (Transfer Station) and in the Requesting Party itself. See p.181 "Transfer Report".
- Program the same Polling ID in both this machine (Transfer Station) and the Requesting Party. See p.183 "Programming a Polling ID".
- The Requesting Party's fax number must be programmed in the destination list of this machine (Transfer Station). The registration number must be between 00001 and 00100.
- The End Receiver's fax number or e-mail address must be programmed in the destination list or Group Dial of this machine (Transfer Station).

📌 Note

- r You cannot receive e-mails unless your machine has the capacity to store two or more destinations specified using the number keys.
- r If the Requesting Party specifies a Group for the Receiving Stations and the total number of Receiving Stations exceeds 500, the Transfer Station cannot transfer the message and sends a Transfer Result Report to the Requesting Party.

- r If the Requesting Party specified a destination with both the fax number and e-mail address programmed in Transfer Station as End Receiver, this machine sends the message to the fax number or e-mail address according to the User Parameter setting. See p.159 "User Parameters" (switch 32, bit 0).

 **Multistep transfer**

The principles of Transfer Stations can be used to build up a multi-step facsimile network where messages are passed through several Transfer Stations. By programming the Receiving Stations in a Transfer Station Group, you can enable this machine to transfer messages onto other Transfer Stations.

For more information, contact your service representative.

This function can only be used if the machines are made by the same manufacturer.

 **Sending the Transfer Result Report**

This machine compares the fax number of the Requesting Party with the Requesting Party's number programmed as a Quick Dial or Speed Dial. If the lower five digits of the two numbers match, it sends the Transfer Result Report to the Requesting Party.

For example:

- Requesting Party's own dial number:
001813-11112222
- Transfer Station's Quick Dial:
03-11112222

Transfer Result Report

 **Preparation**

Program the Requesting Party fax number into a Quick Dial key in the Transfer Station (this machine) in advance.

Program your own fax number. See p.181 "Transfer Report".

Program the Polling ID. See p.183 "Programming a Polling ID".

This reports whether transmission to the Receiving Stations was successful or not.

When the Transfer Station has transferred the message to all Receiving Stations, it sends the Transfer Result Report back to the Requesting Party. The machine prints the report if it cannot be sent back to the Requesting Party.

 **Note**

- r You can set whether a portion of the original image is printed on the report with the User Parameters. See p.159 "User Parameters" (switch 04, bit 7).
- r Unprogrammed destination column indicates the message could not be sent because either the end receiver's fax number or e-mail address is incorrect, or not programmed.
- r -- column indicates the Internet Fax was sent to the mail server programmed in this machine.

Transfer Result Report (transfer request by e-mail)

When this machine receives a transfer request by e-mail, the Transfer Result Report is sent by e-mail to the Requesting Party after completing all transmissions to the specified Transfer Stations. If the Key Operator's e-mail address has been programmed, the Transfer Result Report e-mail is forwarded to that address.

Note

- r Unprogrammed destination column indicates the message could not be sent because either the End Receiver's fax number or e-mail address is incorrect, or not programmed.
- r -- column indicates the Internet Fax was sent to the mail server programmed in this machine.
- r When using multistep transfer, the Transfer Result Report e-mail is sent to the last Transfer Station that sent Transfer Request.

Forwarding Received Documents

This machine can forward received documents to other destinations programmed in memory based on Own Name, Own Fax Number or sender's e-mail address. If a sender's e-mail address is programmed as the destination, documents received are forwarded as e-mail.

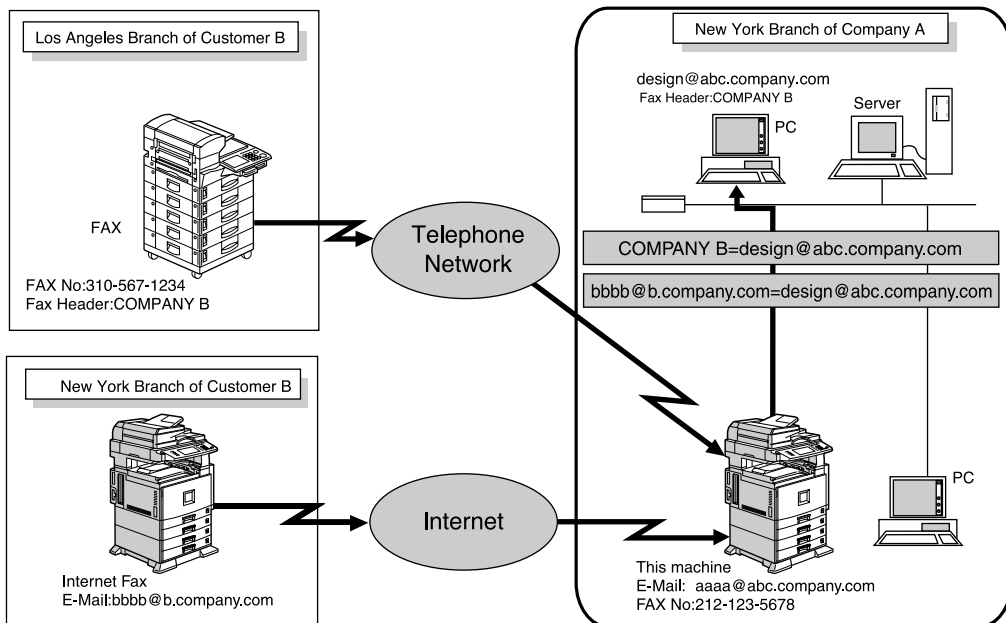

Note

- r You need to specify the Forwarding destination in advance. See p.155 "Forwarding".

- r If you want to forward documents to a different destination depending on the sender, see p.163 “Special Senders to Treat Differently”.
- r You can select whether the machine prints out the messages it forwards with User Parameters (switch 11, bit 6). For details, see p.159 “User Parameters”.

Routing Received Documents with SUB Code

When a document is received, its SUB Code is compared to user codes programmed in Personal Boxes and, if a match is found, the document is routed to the destination whose user code is specified. If the destination specified is an e-mail address, the received document is routed to that destination as e-mail.

In addition to SUB Codes, you can use the forward feature to send all received transmissions to a specific e-mail address. See p.155 “Forwarding”.

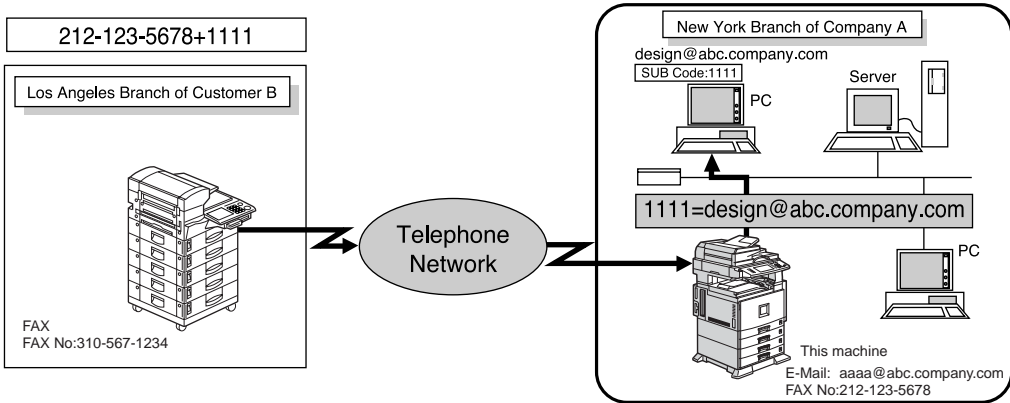

Note

- r You can route documents received from any fax machine, regardless of manufacturer.
- r Before routing received documents, you must set up a Personal Box and routing address. See p.172 “Programming/changing Personal Boxes”.
- r This function is not available when you have set received documents to be delivered to the network delivery server.

Transferring Received Documents

Originals sent with a SUB Code that matches the SUB Code programmed as a Transfer Box are received then relayed to the programmed receiver.

When e-mail addresses are programmed in the Transfer Station as receivers, received messages are sent in an e-mail format to the receivers.

Preparation

Transfer Boxes and Receiving Stations must be set up in order to transfer received documents. See p.178 "Programming/changing Transfer Boxes".

Note

- r Transfer Results are not sent back to Requesting Party.
- r You can transfer data received from any fax machine, regardless of manufacturer.

SMTP Reception Using Internet Fax

This machine ordinarily uses POP e-mail reception, but can be set to use SMTP reception.

With POP reception, e-mail is received using Auto Mail Reception or Manual Reception.

With SMTP reception, e-mail is received as soon as it is sent to the e-mail address set by the machine. You can route received e-mail to other Internet Fax machines also.

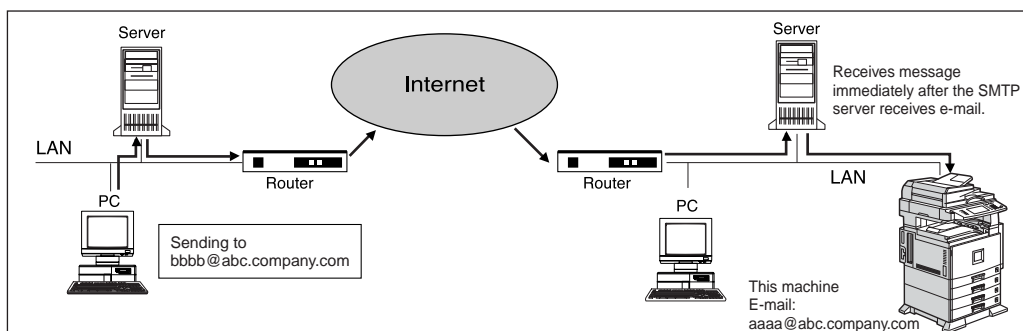

Note

- r DNS server settings must be made before using SMTP reception.
- r To use SMTP reception, set the reception protocol to SMTP. See "Settings You Can Change with User Tools - File Transfer", *Network Guide*.
- r Even if SMTP reception is enabled on the DNS server, e-mail sent from the SMTP server will not be received and the machine reports an error if SMTP reception is not set. Also, the SMTP server sends an error notification to the originator.
- r If an error is encountered during e-mail reception, reception is aborted, the e-mail is discarded, and Error Report is printed. Also, the SMTP server sends an error notification to the originator.

- r When the SMTP server attempts to route received documents to this machine while the machine is transmitting an e-mail, the machine will respond to the SMTP server with a "busy" signal. Then, the SMTP server usually tries resending the documents until the set timeout.

Reference

- p.63 "Auto E-mail Reception", *Facsimile Reference <Basic Features>*
- p.63 "Manual E-mail Reception", *Facsimile Reference <Basic Features>*
- p.94 "Routing E-mail Received via SMTP"

Routing E-mail Received via SMTP

E-mail received via SMTP can be routed to other fax machines. It can also be routed to destinations programmed as Quick Dial entries or Groups.

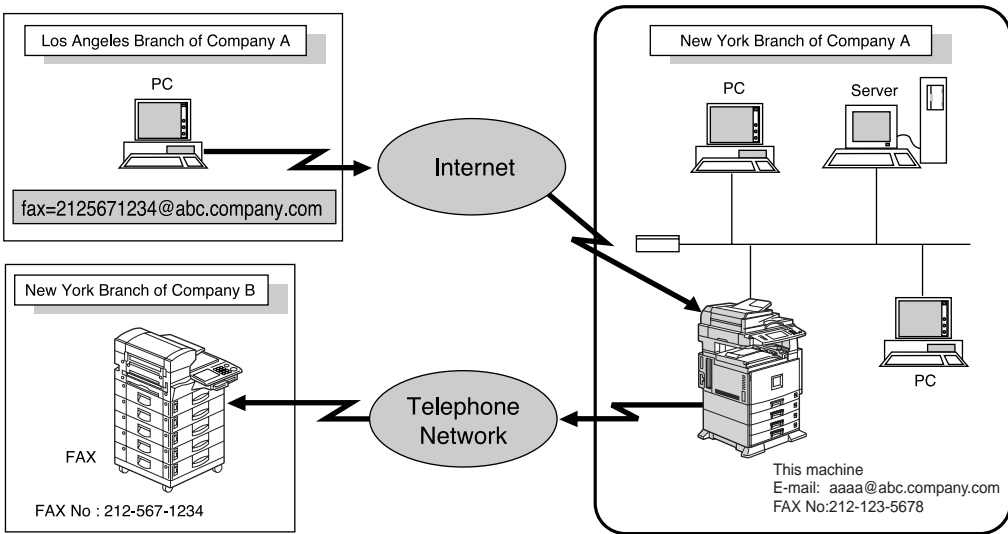

Preparation

Before routing e-mail received via SMTP, you first must set "SMTP RX File Delivery Settings" to "On". See p.145 "E-mail Settings".

Note

- r If an e-mail transfer request is received when the "SMTP RX File Delivery Settings" to "Off", this machine responds with an error message to the SMTP server.
- r You can make settings that limit transfer to specified originators. See p.145 "E-mail Settings".
- r Using this function, you can also send documents from your e-mail software to e-mail addresses and G3 fax machines' destinations through this machine simultaneously. For details about specifying the destinations of fax machines, see the following.

Specifying E-mail Transfer

The originator can request transfer of e-mail sent to another fax machine by specifying the e-mail address as follows:

v Fax Number

fax=destination fax number@host name of this machine. domain name

Example: to transfer to fax number 212-123-4567, specify:

fax=2121234567@abc.company.com

v Quick Dial Destination

fax=#registration number of 5 digits or less@host name of this machine.domain name

Example: to transfer to the destination number 00001:

fax=#00001@abc.company.com

v Group Destination

fax=#**registration number of 5 digits or less@host name of this machine.domain name

Example: to transfer to the destination programmed under Group number 04:

fax=#**04@abc.company.com

JBIG Reception

The optional fax function upgrade unit is required.

If you use JBIG (Joint Bi-level Image Experts Group) compression, you can send photographic originals faster than with other methods of compression. You can only use this function with G3 line type. It allows you to receive messages sent in the JBIG format through JBIG Transmission.

Limitation

r If ECM is turned off, JBIG Reception is unavailable. See p.78 "ECM (Error Correction Mode)".

Note

r When the optional extra G3 interface unit is installed, JBIG receptions of G3-2 and G3-3 lines are as standard.

Auto Fax Reception Power-up

This machine can be set to shut down automatically if no one has used it for a while. In these situations, even though the operation switch is off, the machine can still receive incoming messages as long as the main power switch is on.

Important

r Reception is not possible if both the operation switch and main power switch are turned off.

Note

r You can set whether messages are printed as soon as they are received (Immediate Reception) with the User Parameters. See p.159 "User Parameters" (switch 14, bit 0).

r You can also have fax messages received by Memory Reception (Substitute Reception) printed after the machine is turned on.

Printing Options

Print Completion Beep

When this function is turned on, the machine beeps to let you know when a received message has been printed.

Note

- r You can alter the volume of the beep or turn it off completely (set the volume to the minimum level). See p.75 “Adjusting the Volume”, *Facsimile Reference <Basic Features>*.

5

Checkered Mark

When this function is turned on, a Checkered Mark is printed on the first page of fax messages to help you separate them.

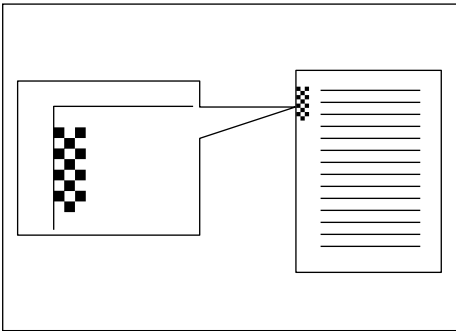

Note

- r You can turn this function on or off using Reception Setting. See p.144 “Reception Settings”.

Center Mark

When this function is turned on, marks are printed halfway down the left side and at the top center of each page received. This makes it easy for you to position a hole puncher correctly when you file received messages.

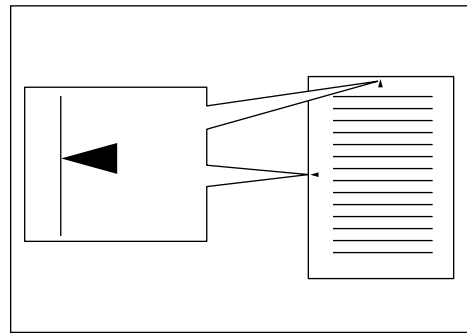

Note

- r The Center Mark may deviate a little from the exact center of the edge.
- r You can turn this function on or off using Reception Settings. See p.144 “Reception Settings”.

Reception Time

You can have the date and time printed at the bottom of the message when it is received. You can turn this function on or off using Reception Settings. See p.144 "Reception Settings".

Note

- r When a received message is printed on two or more sheets, the date and time is printed on the last page.
- r The date and time when the message was printed can also be recorded on the message. If you need this function, contact your service representative.

Two-Sided Printing

You can have a received message printed on both sides of a sheet. You can turn this function on or off using Reception Settings. See p.144 "Reception Settings".

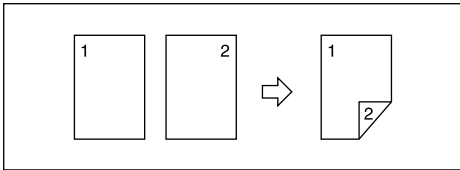

Limitation

- r To use this function, all pages of the received document must be of the same size—inform the sending party of this beforehand if necessary. You must also have paper set in your machine of the same size as that sent by the sending party. In Two-Sided Printing, this machine will correctly receive in A3, B4 JIS (Japanese Industrial Standard), A4, B5 JIS, A5 (11"×17", 8 1/2"×14", 8 1/2"×11", 8 1/2"×5 1/2"). The following table shows the results that can be achieved when receiving with this machine.

	Originals	Top binding	Side binding
A4, B5 JIS, A5, 8 1/2" × 11", 8 1/2" × 5 1/2"			
A3, B4 JIS, 11" × 17", 8 1/2" × 14"			

- r This function works only when all pages are of the same width and received into memory.
- r This function cannot be used with Combine Two Originals.

Note

- r The machine will use Memory Reception for Two-Sided Printing.
- r Printouts may vary depending on how the sender sets the originals.
- r You can select to have messages only from selected senders printed in this way. See p.163 “Special Senders to Treat Differently”.
- r Stored documents of the same size are printed on the same paper. Some stored documents may be unavailable for this printing option.

180-Degree Rotation Printing

When printing on both sides of the paper, this machine rotates images as shown in the diagram.

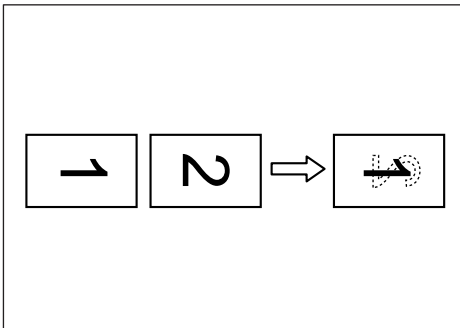

Multi-copy Reception

If you switch this function on, multiple copies of each incoming fax message will be printed. You can also select to have multiple copies made of messages from particular senders. See p.163 “Special Senders to Treat Differently”. See p.144 “Reception Settings”.

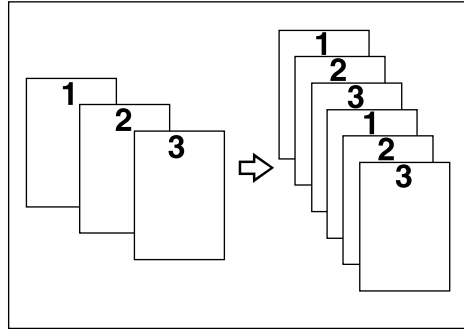

Note

- r The maximum number of copies that can be made for each message is 10.
- r When you are using the Multi-Copy function with specified senders, the maximum number of copies is 10.
- r You can turn this function on or off using Reception Settings. See p.144 “Reception Settings”.
- r The machine will use Memory Reception for Multi-copy Reception.

Image Rotation

If you have set paper in the standard tray , incoming fax messages will be rotated automatically to fit onto the paper.

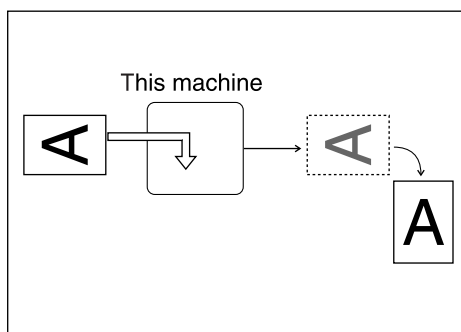

Note

You can choose to have received messages printed from a specified tray. See p.144 "Reception Settings".

Combine Two Originals

When two messages of the same size and orientation are received consecutively, they are printed on a single sheet when you turn this function on. This can help you economize on paper.

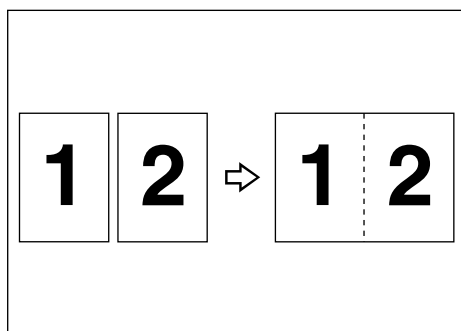

- Two A5 messages are printed side by side on a sheet of A4 .

- Two B5 JIS messages are printed side by side on a sheet of B4 JIS .
- Two A4 messages are printed side by side on a sheet of A3 .
- Two 8¹/₂"×5¹/₂" messages are printed side by side on a sheet of 8¹/₂"×11" .
- Two 8¹/₂"×11" messages are printed side by side on a sheet of 11"×17" .

Limitation

- This function does not work with messages larger than A5 , B5 JIS , A4 , 8¹/₂" × 11" or 8¹/₂" × 5¹/₂" . When A5 , B5 JIS , A4 , 8¹/₂" × 11" or 8¹/₂" × 5¹/₂" size paper is loaded in the machine, each page of the received message is printed on a single sheet.
- If paper matching the size and orientation of a received document is unavailable, Combine Two Originals is not possible.
- When Combine Two Originals and 2-Sided Printing are selected at the same time, Combine Two Originals takes priority and 2-Sided Printing is canceled.

Note

- You can turn this function on or off with the User Parameters. See p.159 "User Parameters" (switch 10, bit 1).
- This function uses Memory Reception.

Page Separation and Length Reduction

When the size of a received message is longer than the paper loaded in the machine, each page of the message can be split and printed on several sheets, or reduced and printed on a single sheet. For example, this function splits the message if the message length is 20 mm (0.79") or longer than the paper used. The message is reduced if it is less than 20 mm (0.79"). When a message is split, an asterisk (*) is inserted at the split position and about 10 mm (0.39") of the split area is duplicated on the top of the second sheet.

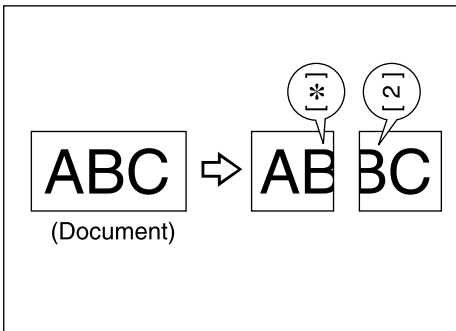

Note

- r Your service representative can customize this function with the following settings:
 - Reduction
 - Print split mark
 - Overprinting
 - Overprinting length
 - Guideline for split
- r You can adjust the overprinting and reduction lengths within the following ranges:
 - Overprinting length: 4 mm (0.16"), 10 mm (0.39"), 15 mm (0.59")
 - Guideline for split: 5-155 mm (5 mm steps)/0.2"-6.1" (0.2" steps)

Reverse Order Printing

Normally, received pages are printed and stacked on the tray in the order they are received. If you turn this function on, the machine will start printing the message from the last page received.

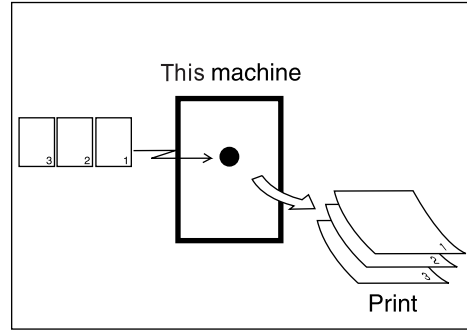

Note

- r You can turn this function on or off using Reception Settings. See p.144 "Reception Settings".
- r When this function is on, the first page will be printed last.
- r This function uses Memory Reception.

Page Reduction

If you receive a message that is longer than the paper in the tray, the machine usually prints it on two pages. If you turn this function on, the machine reduces the width and length of the received image so that it will fit on one page. If A4 paper is loaded and a message of B4 JIS size is received, the machine will reduce the message to a single A4 sheet.

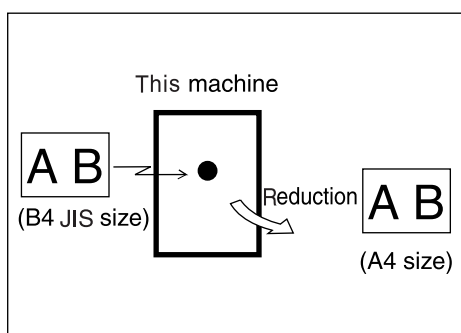

Note

- r You can turn this function on or off with the User Parameters. See p.159 "User Parameters" (switch 10, bit 3).
- r When this function is used, the printing quality may not be as good as usual.

Reference

p.100 "Page Separation and Length Reduction"

TSI Print (Transmitting Subscriber Identification Print)

Usually the sender's Fax Header is printed on received messages. If the sender has not programmed their Fax Header, you will not be able to identify them. However, if you turn this function on, the sender's Own Name or Own Fax Number is printed instead so you can find out where the message came from. When you receive an Internet Fax, the e-mail address of the sender is printed.







Reference



p.67 "Initial Settings and Adjustments", *Facsimile Reference <Basic Features>*

Note

- r You can turn this function on or off in the User Parameters. See p.159 "User Parameters" (switch 02, bit 3).



When There Is No Paper of the Correct Size

If there is no paper in your machine that matches the size of a received message, the machine will choose a paper size based on the paper available. For example, if your machine has 8 1/2"x11"  and A3  loaded and you receive a A4  size message, check the A4  column of the following table. The paper size at the top has highest priority. In this case, since 8 1/2"x11"  is given a higher priority than A3 , the message is printed on 8 1/2"x11" .





If only B5 JIS  is loaded and you receive an A3  message, the received message is stored in memory and not printed.

v Priority Table

		Received Image Size						
		A3,DLT 	B4 JIS 	A4,LT 	A4,LT 	B5 JIS 	LG 	F/F4 
Paper Select Priorities	1	A3 	B4 JIS 	LT 	A4 	B5 JIS 	LG 	F/F4 
	2	DLT 	A3 	LT 	A4 	B5 JIS 	A4 	LG 
	3	A4 	DLT 	A4 	LT 	B4 JIS 	A4 	A4 
	4	A4 	B5 JIS 	A4 	LT 	A4 	LT 	A4 
	5	LT 	B5 JIS 	F/F4 	A3 	A4 	LT 	LT 
	6	LT 	A4 	LG 	F/F4 	LT 	F 	LT 
	7	F/F4 	A4 	A3 	DLT 	LT 	B4 JIS 	B4 JIS 
	8	B4 JIS 	LT 	B4 JIS 	B4 JIS 	F/F4 	A3 	A3 
	9	LG 	LT 	DLT 	LG 	A3 	DLT 	DLT 
	10		F/F4 	HLT 		DLT 	HLT 	HLT 
	11		LG 	A5 		LG 	A5 	A5 

-  Portrait
-  Landscape
-  Image Rotation

Page reduction	Disabled
Reduction in Sub-scan Direction	Enabled
Page Separation Threshold	20 mm (0.79")
Width or Length Priority	Width

-   and   indicate that the message is split over two pages of paper with the orientation and size shown.

Note

- r Paper placed in the bypass tray is not usually selected for printing a received message. However, you can use this tray if you select the bypass tray as the main paper tray using Reception with Specified Senders. See p.163 "Special Senders to Treat Differently".
- r Widths that this machine can receive are A4, B4 JIS, LT (8 1/2"x11"), and A3. Any messages narrower than A4 or LT (8 1/2"x11") are sent as A4 or LT (8 1/2"x11") width with the length unchanged.
- r The paper size used to print a received message may be different from the size of the sent original.
- r If you specify a receiving tray with the setting priority under System Settings, the messages may be received in a different order by setting the priority table. The priority tray may be used only when the document received is the same size as the priority tray.

Reference

- p.100 "Page Separation and Length Reduction"
- p.101 "Page Reduction"
- p.99 "Image Rotation"
- "Tray Paper Settings", *General Settings Guide*

Setting priority trays

With the same size of paper loaded into multiple trays, you can make the machine use one tray for one function and another tray for another function. For example, you may load white A4 paper into tray 1 to use when making copies, and yellow A4 paper into tray 2 to use when printing received faxes. You can then easily identify for which purpose paper has been output. You can perform this setting using System Settings. See *General Settings Guide*.

Note

- r When a different size of document from the priority tray is received, the tray containing the same size of paper as the received document is used.

Just size printing

If you turn this function on and no paper tray is stocked with paper of a suitable size to print a received document, a message will appear on the display prompting you to load paper of the required size. When you have loaded new paper, you can then print the message.

Two messages can appear:

- Paper tray



- Bypass Tray

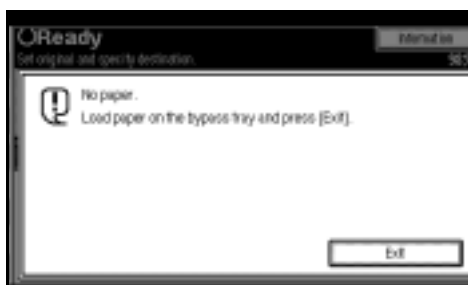

Limitation

- r If the paper tray is pulled out or the machine runs out of the specified size of paper, the message will not be printed. Be sure the paper tray is inserted.
- r The action that follows pressing **[Exit]** varies depending on the status of the machine when the message occurred.
 - If any received documents or reports were being printed automatically, the printer automatically continues printing from where it left off.
 - If any documents or reports were being printed manually, the printer does not resume printing. Perform the operation from the beginning again.

Note





- r You can turn this function on or off with the User Parameters. See p.159 "User Parameters" (switch 05, bit 5).

Having Incoming Messages Printed on Paper from the Bypass Tray

You can have messages sent from Specified Senders printed on paper from the bypass tray. This is useful if you need messages printed on a size of paper not stocked in the paper tray(s).

You can load a maximum of 100 sheets of standard paper in the bypass tray.

Note

- r Before you can use this function, you need to turn on Authorized Reception (Initial Setup Reception Mode settings), program the Specified Senders (Key Operator Settings) along with the paper. See p.144 "Reception Settings". See p.163 "Special Senders to Treat Differently".
- r The print area is determined by the optional expansion memory, resolution, and the vertical length of the originals.
- r If paper longer than 600 mm (23.62") is used, the paper may get wrinkled, it may not be sent, or a paper jam may occur.
- r The machine can detect A4 , A3  (8¹/₂"×11" , 11"×13" ) paper sizes. When you load any other size, specify the paper size. See p.170 "Programming Bypass Tray Paper Size".
- r When using tray 1 of the optional 1000-sheet finisher, paper is output to the tray even with non-standard sizes selected.

- r If the specified paper size and the size of paper set in the bypass tray do not match, paper jams may occur, or the image may be truncated.
- r If messages are printed on paper smaller than A4, the image may be truncated, or split across sheets.
- r If you use this function, Image Rotation and 180-Degree Rotating Printing are not possible.

Where Incoming Message are Delivered - Output Tray

Specifying Tray for Lines

The optional extra G3 interface unit is required.

You can specify the document feeding tray for each port (telephone or LAN). For example, you can specify documents received through the G3 -1 port to be fed to the "Internal Tray 1" and documents received through the G3 -2 port to be fed to the "Internal Tray 2", facilitating separation of files. You can also set the machine to output Internet Faxes and ordinary faxes onto different trays.

Note

r To use this function, specify the port and destination using **[Specify Tray for Lines]**. See p.144 "Reception Settings".

Tray Shift

The optional finisher is required.

When the optional finisher unit is selected for fax output, you can use the Tray Shift function whenever a fax or report is printed.

This is useful for separating faxes stacked in the finisher output tray. For example, if the previous incoming fax was output to the left, the next incoming fax will be output to the right and vice-versa.

Note

r You can turn this function on or off with the User Parameters. See p.159 "User Parameters" (switch 19, bit 0).

6. LAN-Fax Features

Sending Fax Documents from Computers

The optional printer/scanner unit is required.

Using computers connected to the machine through parallel ports, IEEE 1394 (IP Over 1394) ports, LANs, or wireless LANs, you can fax documents, created using Windows applications, to other fax machines over a telephone line.

- To send a fax, simply select **[Print]** from the Windows application, then select LAN-Fax as the printer, and then specify a destination.
- In addition to sending faxes, LAN-Fax Driver allows this machine to be used for printing out documents prepared on a computer for proof checking.
- To use LAN-Fax Driver, connect this machine to a LAN and make the necessary network settings, and then install LAN-Fax Driver and related utilities on your computer.

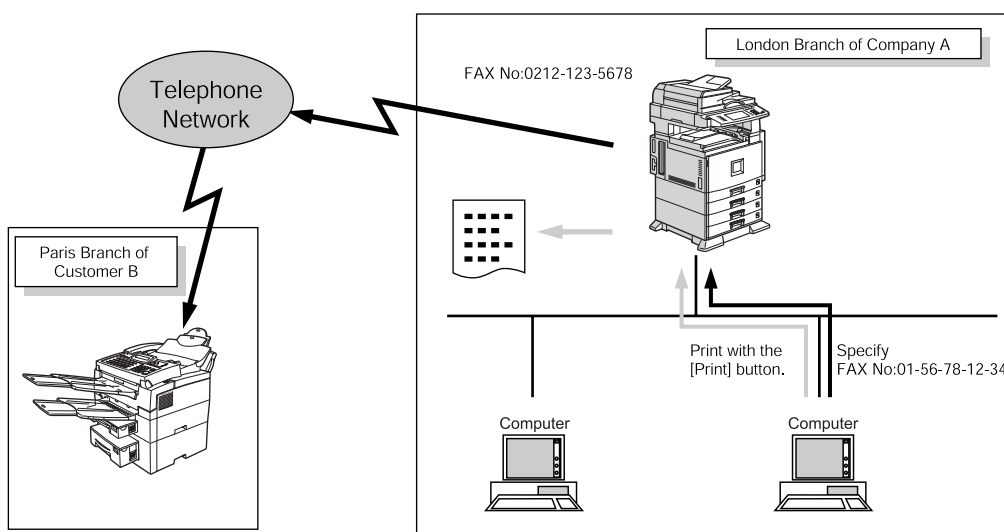

Important

- r Errors occurring when the machine is used as a LAN-Fax will not be displayed on the computer. Check the help menus using a Web browser.

Before Use

To use these features, a LAN-Fax Driver must be installed on your computer. Use the LAN-Fax driver included on the printer CD-ROM. You must also make the required computer to fax network settings on the machine, according to the type of connection.

Reference

When a personal computer and the machine are connected in parallel:

See "System Settings (Parallel Connection)", *Printer Reference 2*.

When using Ethernet, IEEE 1394 (IP over 1394), or IEEE 802.11b (wireless LAN):

See "User Tools (System Settings)", *Network Guide*.

Installing the Software

You need to install LAN-Fax Driver on your computer before using the LAN-Fax functions. LAN-Fax Driver is on the CD-ROM included with the printer.

Address Book and LAN-Fax Cover Sheet Editor are installed with LAN-Fax Driver. Address Book helps you edit LAN-Fax transmission destinations. LAN-Fax Cover Sheet Editor helps you edit LAN-Fax cover sheets.

Note

r The following explanation assumes that you are familiar with general Windows procedures and practices. If you are not, see the documentation that comes with Windows for details.

Auto run program

With Windows 95/98/Me, Windows 2000/XP, and Windows NT 4.0, the installers for various drivers and utilities launch automatically as Auto Run programs when you insert the CD-ROM.

If your operating system is Windows 2000/XP or Windows NT 4.0, installing a printer driver using Auto Run requires Administrator permissions. When you install LAN-Fax Driver using Auto Run, log on using an account that has Administrator permissions.

Note

- r If the plug and play function starts, click **[Cancel]** in the **[New Hardware Found]**, **[Device Driver Wizard]**, or **[Found New Hardware Wizard]** dialog box, and then insert the CD-ROM. The **[New Hardware Found]** or **[Found New Hardware Wizard]** dialog box appears depending on the system version of Windows 95/98/Me, Windows 2000, or Windows XP.
- r Auto Run might not work automatically with certain OS settings. If this is the case, double-click "Setup.exe", located on the CD-ROM root directory.
- r If you want to cancel Auto Run, hold down the **[SHIFT]** key (when your system is Windows 2000/Windows XP, hold down the left **[SHIFT]** key) while inserting the CD-ROM. Keep the **[SHIFT]** key hold down until the computer stops reading the CD-ROM.
- r Clicking **[Cancel]** during installation aborts the installation. If you cancel the installation, restart your computer and install the rest of the software or printer driver.

LAN-Fax Driver, Address Book, and LAN-Fax Cover Sheet Editor can be installed by Auto Run.

Installing individual applications

Preparation

Before installing the above applications, install SmartNetMonitor for Client. See “Installing SmartNetMonitor for Client/Admin”, *Printer Reference 1*.

Use the following procedure to install LAN-Fax Driver, Address Book, and LAN-Fax Cover Sheet Editor at one time.

1 Quit all applications currently running.

2 Insert the CD-ROM included with this machine into the CD-ROM drive of your computer.

The installer launches automatically, and the language selection window appears.

Note

r Depending on your operating system settings, the installer may not launch automatically. If it does not, double-click “SETUP.EXE” in the CD-ROM root directory to launch the installer.

3 Select the interface language of the software, and then click [OK].

4 Click [LAN-Fax Driver].

The software license agreement window appears.

5 Read all of the terms and, if you agree, select [I accept the agreement], and then click [Next].

Note

r If you select [I don't accept the agreement], you cannot complete the installation.

6 Click the [LAN-Fax Driver] check box, and then click [Next].

7 Confirm that the [Printer Name:<LAN-Fax M3>] check box has been selected, and then click [Continue].

Note

r Select the desired port.

8 Click [Finish].

The installation completion dialog box appears.

9 Click [Finish].

10 Click [Exit].

Applications Stored on the CD-ROM

This section provides information about LAN-Fax Driver, Address Book, and LAN-Fax Cover Sheet Editor.

LAN-Fax Driver

This driver allows you to use LAN-Fax functions.

v Location of the File

The following folders are on the CD-ROM:

- LAN-Fax Driver for Windows 95/98/Me
DRIVERSLAN-FAXWIN9X_Me
- LAN-Fax Driver for Windows 2000/XP
DRIVERSLAN-FAXWIN2K_XP
- LAN-Fax Driver for Windows NT 4.0
DRIVERSLAN-FAX T4

v Operating Environment

- Computer
PC/AT Compatible
- Operating Systems
Microsoft Windows 95/98/Me
Microsoft Windows 2000/XP
Microsoft Windows NT 4.0
- Display
VGA 640×480 dots or more

! Limitation

- r All operations cannot be guaranteed depending on the system environment.
- r When you use Windows NT, LAN-Fax Driver will not work in an RISC base processor (MIPS R series, Alpha AXP, PowerPC) environment.

📝 Note

- r Before beginning installation, exit all other applications.

Address Book

Address Book helps you edit LAN-Fax transmission destinations.

v Operating Systems

Microsoft Windows 95/98/Me
Microsoft Windows 2000/XP
Microsoft Windows NT 4.0

LAN-Fax Cover Sheet Editor

LAN-Fax Cover Sheet Editor helps you edit LAN-Fax cover sheets.

v Operating Systems

Microsoft Windows 95/98/Me
Microsoft Windows 2000/XP
Microsoft Windows NT 4.0

Setting LAN-Fax Properties

This section describes how to make settings such as paper size, resolution, and options.

- Paper size
- Orientation
- Tray
- Resolution
- Gray scale
- Printing images of True Type fonts

When this machine is connected to a network, selections for the option configuration are automatically performed.

For details, see Help.

Note

- r If the options on this machine are not configured as instructed, LAN-Fax functions may fail to work as intended.
- r If your operating system is Windows 2000/XP or Windows NT 4.0, log on using an account that has Administrator permissions.

1 On the [Start] menu, point to [Settings], and then click [Printers].

Note

- r With Windows XP Professional, select [Printers and Faxes] on the [Start] menu.
- r With Windows XP Home Edition, select [Control Panel] on the [Start] menu. Next select [Printers and Other Hardware], and then [Printers and Faxes].

2 Double-click [LAN-Fax M3], and then click [Properties] on the [File] menu.

Note

- r With Windows NT, click [Document Default] on the [File] menu.

3 Make settings for the option configuration.

When using Windows 95/98/Me

A Click the [Paper] tab.

B Click [Accessories...].

When using Windows 2000, Windows XP, or Windows NT

A Click the [Advanced] tab.

B Click [Printing Defaults...].

C Click [Accessories...].

4 Confirm the settings for the option configuration.

When using a network

A If the settings do not match the installed optional units, click [Reload from Device].

When not using a network

A Select the check box besides the installed optional units.

5 Click [OK].

The settings for the option configuration are completed.

6 Click [OK].

Basic Transmission

This section describes how to send fax documents created using Windows applications.

To send a fax, simply select **[Print]** from the Windows application, then select **[LAN-Fax]** as the printer, and then specify a destination in the **[LAN-Fax]** dialog box.

Open the application document you want to send or create a new document, and then perform the following procedure.

For details, see Help.

Limitation

- r When using SmartNetMonitor for Client, you cannot send documents to this machine using more than one LAN-Fax at the same time.

Note

- r To send to an Internet Fax destination, the destination must be set in the destination list of this machine beforehand. Use this machine's destination list to specify Internet Fax destinations. E-mail addresses cannot be entered in the LAN-Fax dialog box.

1 On the **[File]** menu, click **[Print]**.

2 Select **[LAN-Fax M3]** in **[Printer Name]**.

3 Click **[OK]**.

The LAN-Fax dialog box appears.

Note

- r The setting method may differ depending on the application you are using. In all cases, select **[LAN-Fax M3]** for the printer.

4 Specify the destination.

Use one of the following procedures to specify a destination. For details, see Help.

Note

- r You can select the appropriate line in the **[Line:]** list.
- r You can specify up to 500 destinations.
- r The machine can hold up to 64 documents sent using LAN-Fax, as those to be transmitted.

Specifying a destination using a destination list

A Enter a destination in the **[Fax Number:]** box.

When using a destination list:

Enter **[#]** and the registration number.

B Click **[Next Number]**.

The entered destination is added and displayed in the **[List of Destinations:]** box.

Note

- r If you do not want the entered destination to be added to the list, skip this step. Also when this step is skipped, the document will be sent to the number entered in the **[Fax Number:]** box.

C To specify more destinations, repeat steps **A** and **B**.

Specifying a destination by directly entering a fax number

A Enter a fax number in the **[Fax Number:]** box.

Note

- r To enter a pause, click **[Pause]**.

B Click [Next Number].

The entered destination is added and displayed in the **[List of Destinations:]** box.

 **Note**

- r If you do not want the entered destination to be added to the list, skip this step. Also when this step is skipped, the document will be sent to the number entered in the **[Fax Number:]** box.

C To specify more destinations, repeat steps A and B.

Specifying a destination using Address Book

In order to use this method, you need to register destinations in the address list using Address Book. See p.110 "Address Book".

A Select a CSV file containing the desired address list, from the drop-down menu. **Note**

- r Up to three files used most lately appear in the drop-down menu. To use an address list that did not appear, click **[Browse...]**, and then select the file.

B In the [Name:] list select [Contact], [Company], or [Group], and then select [ALL] or an initial letter.

The destinations matching the selected parameters appear.

C Click the destination to highlight it, and then click [Set as Destination].

The entered destination is added and displayed in the **[List of Destinations:]** box.

D To specify more destinations, repeat steps B and C.**5 Specify options.** **Reference**

See p.113 "Attaching a cover sheet".

See p.116 "Specifying Two-Sided Printing".

See p.114 "Previewing fax images".

See p.115 "Printing and Saving".

See p.114 "Specifying options".

If you do not want to specify options, proceed to step **6**.

6 Click [Send]. **Note**

- r When you click **[Print & Send]**, a fax will be transmitted to the destination and a copy of the document you send will be printed from your machine.

Attaching a cover sheet

Selecting the **[Attach a Cover Sheet]** check box causes a cover sheet to be attached to the top of the fax document.

The cover sheet includes the following items:

- Company name as destination info.
- Department name as destination info.
- Person name as destination info.
- Title of address as destination info.
- Company name as sender info.
- Department name as sender info.
- Person name as sender info.

- Telephone number as sender info.
- Fax number as sender info.
- Date
- Message

Note

- r To edit the cover sheet, click **[Cover Sheet...]**. See p.118 "Editing Fax Cover Sheets".

Previewing fax images

Selecting the **[Preview]** check box allows you to check how the fax document will be output at the destination.

- 1** Select the **[Preview]** check box, and then click **[Print]** or **[Send]**.

The **[Preview]** window appears.

- 2** Check the image, and then click **[OK]**.

Note

- r To cancel printing or sending, click **[Cancel]**.

Images on the Preview window are not exactly the same as images to be output.

Specifying options

You can specify the following options:

For details, see Help.

- Sending at a Specific Time
- User Code
- User ID
- Print Fax Header
- Document Server

- 1** Click **[Option...]**.

- 2** Specify options you want to use.

- v **To send the fax document at a specific time:**

Select the **[Sending at Specific Time]** check box, and then specify a transmission time.

- v **To send with a user code:**

Enter a user code into the **[User Code]** field.

- v **To distinguish fax documents for each user:**

Enter a user ID into the **[User ID:]** field. Use this option when checking the job history using SmartNetMonitor for Client.

- v **To have the header printed on the fax document:**

Select the **[Print Fax Header]** check box.

- v **To store the fax document on the Document Server:**

Select the **[Send to Document Server]** check box, and then enter a user name, file name, and password.

Note

- r The user code you specified for this machine must be the same as the one entered in this machine. See *General Settings Guide*.
- r If **[Hard Disk Unit]** has not been selected in the **[Accessories]** window, you cannot perform selection for "Document Server". See p.111 "Setting LAN-Fax Properties".

- 3** Click **[OK]**.

Transmission result notification

After you have sent faxes, this function informs you whether the fax was successfully transmitted to its destination or not.

When you store documents in the Document Server or use this machine just as a printer, this function also informs you whether data was successfully transmitted to this machine or not.

Note

- r You cannot receive notification when using SmartNetMonitor for Client version 5.0 or earlier.
- r Transmission results are informed only when connected with a network using SmartNetMonitor for Client.

Managing transmission using LAN-Fax Driver

From “SmartNetMonitor for Admin”, “SmartNetMonitor for Client”, or a Web browser, you can manage transmissions using LAN-Fax Driver. You can view the following information on transmitted files using LAN-Fax Driver.

- User ID
- Status
- Number of pages
- Start time
- File No.

Reference

For details, see Help.

Printing and Saving

You can print documents created using Windows applications.

You can also save documents in TIF format.

Open the application document you want to print or create a new document, and then perform the following procedure.

For details, see Help.

Note

- r You can select whether to cause the machine to automatically restart printing when problems such as paper running-out or paper jams are resolved. The machine may not allow LAN-Fax Driver to send documents until it finishes re-printing. See p.159 “User Parameters” (switch 20, bit 1).
- r You can select the time delay after problems are resolved until the machine restarts printing. See p.159 “User Parameters” (switch 20, bit 2/3/4/5).

1 On the **[File]** menu, click **[Print...]**.

2 Select **[LAN-Fax M3]** in **[Printer Name]**, and then click **[OK]**.

The **[LAN-Fax]** dialog box appears.

Note

- r The setting method may differ depending on the application you are using. In all cases, select **[LAN-Fax M3]** for the printer.

Printing

A Click **[Print]**.

Specifying Two-Sided Printing

- A Selecting the **[Duplex printing]** check box.
- B Click **[Print]**.

Saving as Files

You can save the fax document in TIF format.

- A Select the **[Save as file]** check box.
- B Click **[Save to...]**.
- C Select a folder on the folder tree.
- D Select a file naming method.

 **Note**

- r To manually enter a file name, select the **[Specify file name when saving]** check box. To have the program itself name the file, select the **[Automatically create a new file]** check box.

- E Click **[OK]**.

- F Click **[Save]**.

If you have selected **[Automatically create a new file]**, the image file is assigned a name and saved under the specified folder. The file name will be RicH-HMMSS.tif (HH: hours, MM: minutes, SS: seconds).

- G Enter a file name.

 **Note**

- r You can also change the folder in this step.

- H Click **[Save]**.

The image file is saved in the specified folder.

Editing Address Book

You can program and edit destinations in the address list using the Address Book.

For details, see Help.

- 1** On the **[Start]** menu, point to **[Programs]**, **[LAN-Fax Utilities]**, and then click **[Address Book]**.

The Address Book display appears.

 **Note**

- r If LAN-Fax Driver has already started up, click **[Address Book...]**.

- 2** Click **[New/Browse]**, and then select the CSV file containing the address list to be edited.

- 3** Edit an existing destination or program a new one.

 **Note**

- r You can use files created in CSV format, as Address Book data. For this purpose, create CSV files that conform to a certain format. For more information, see Help.
- r You can register the Address Book data of this machine in the LAN-Fax's Address Book.

Programming new destinations

- A Enter the destination.

 **Note**

- r For **[Line:]**, select the appropriate line type; G3, G3-2, or G3-3, G3 Dir. Auto, G3 PABX Auto. Do not select G4 and I-G3, which is unavailable on this machine.

- B Click **[Add]**.

Editing programmed destinations

- A Select the destination you want to edit in the list.

The company name should appear in gray.

- B Edit the data.
C Click **[Update]**.
-

Deleting programmed destinations

- A Select the destination you want to edit in the list.

The company name should appear in gray.

- B Click **[Delete]**.
C Click **[Yes]**.

- 4** Click **[Close]**.

- 5** If you made changes to a destination, a confirmation message appears. To save the changes, click **[Yes]**.

If you do not want to save the changes and want to quit editing, click **[No]**.

To return to the editing display, click **[Cancel]**.

Note

- r The confirmation dialog box does not appear when you have not made any changes after starting Address Book.

Using the machine's Address Book data as the LAN-Fax's Address Book data

You can retrieve the Address Book data of this machine using SmartNetMonitor for Admin and edit it to register in the LAN-Fax's Address Book.

Reference

For more information, see Help on SmartNetMonitor for Admin.

Managing the facsimile functions using SmartNetMonitor for Admin

Using SmartNetMonitor for Admin, you can check information about the machine's facsimile functions and save the information on the computer.

SmartNetMonitor for Admin provides the following management functions:

Using **[Address Management Tool]**, you can check the information about destinations programmed on the machine and change the fax numbers and names of these destinations. You can also register a new destination.

Using **[Address Management Tool]**, you can retrieve destinations programmed on the machine and save them on the computer as CSV files. You can then export the saved CSV files to the Address Book of LAN-Fax Driver using the Address Book application.

Note

- r For the method of installing SmartNetMonitor for Admin, see the *Printer Reference 1*.
- r For detailed operations, see *Network Guide* and Help on SmartNetMonitor for Admin.

Editing Fax Cover Sheets

LAN-Fax Cover Sheet Editor allows you to edit the format for fax cover sheets. It is necessary to create a cover sheet file before attaching a cover sheet to fax messages using LAN-Fax Driver.

Creating a cover sheet

Use the following procedure to create a fax cover sheet.

You can edit the items below using LAN-Fax Cover Sheet Editor.

- Company name as destination info.
- Department name as destination info.
- Person name as destination info.
- Title of address as destination info.
- Company name as sender info.
- Department name as sender info.
- Person name as sender info.
- Telephone number as sender info.
- Fax number as sender info.
- Date
- Message

Note

r Cover sheet data is stored in its own format (using "fcp" as its extension)

- 1** On the [Start] menu, point to [Programs], [LAN-Fax Utilities], and then click [Cover Sheet Editor].

The dialog box of LAN-Fax Cover Sheet Editor appears.

- 2** Edit the cover sheet.

Note

r For details about operations, see Help.

- 3** Click [Save as...] on the [File] menu.

- 4** Select a folder, and then enter a file name.

- 5** Click [Save].

Attaching a created cover sheet

Use the following procedure to attach a created cover sheet file to a fax message.

- 1** On the [File] menu, click [Print...].

- 2** Select "LAN-Fax M3" in "Printer Name", and then click [OK].

The [LAN-Fax] dialog box appears.

- 3** Click [Cover Sheet...].

The [Cover Sheet...] dialog box appears.

- 4** Select a cover sheet file from the drop-down list or after clicking [Browse...] in [Select Cover Sheet].

Note

r The selection made in [Select Cover Sheet] is not canceled unless you select another file. If you want to change only destination information, skip this step and proceed to step **5**.

- 5** Enter the destination information.

Note

r You can select [(Import from) Address Book], [To Whom It May Concern], [Edit Names], or [None]. Selecting [Edit Names] allows you to enter company, department, and person names.

6 To print the date, select the **[With a Date]** check box.

7 Enter the sender information.

 **Note**

- r You can enter company, department, and person names, and telephone and fax numbers.
- r To add a message, select the **[With a Message]** check box, and then enter a message.

8 Click **[OK]**.

9 Specify a destination.

10 Select the **[Attach a Cover Sheet]** check box.

11 Click **[Send]**.

LAN-Fax Operation Messages

 **Note**

- r You can have the LAN-Fax Error Report printed when options are not properly selected, or there is a communication error with a computer. See p.159 "User Parameters" (switch 20, bit 0).

Message	Causes and Solutions
Cannot access the printer. Click [retry] to send the data again.	Check the network connection. Check that the power is turned on.
The number of entries in Destinations exceed the limits. Up to 500 entries can be entered.	The number of destinations specified exceeds the maximum possible. The maximum number of destinations that can be specified at one time is 500.
"LAN-Fax" has already been launched. Cannot launch it again.	The [LAN-Fax] dialog box is already open. Quit LAN-Fax once, and then start it up again.
Failed to allocate memory.	Available memory on the computer is insufficient. Quit applications currently not in use.

LAN-Fax Error Report

This report is printed when options are not properly selected, or a communication error with a computer occurs. Check the error message of the report.

If you entered a user code in the **[Options]** dialog box, this report can be sent to you by e-mail, provided your e-mail address is programmed in the machine. However, if User Code Management is on for fax, the report is not sent.

 **Note**

- r You can select whether or not a LAN-Fax Error Report is printed. See p.159 "User Parameters" (switch 20, bit 0).

LAN-Fax Result by E-mail

If you entered a user code in the **[Options]** dialog box, the result can be sent to you by e-mail, provided your e-mail address is programmed in the machine.

 **Note**

- r You can select whether or not a LAN-Fax Result is sent to the specified e-mail address. See p.159 "User Parameters" (switch 20, bit 7). If the message failed to be sent to one or more of the specified destinations, the result is sent regardless of this setting.

Viewing Fax Information Using a Web Browser

The optional printer/scanner unit is required.

You can view received fax messages and their lists or print these messages using a Web browser on a network computer.

Note

- r You need to select "Store" as the "Reception File Setting" in the Facsimile Features menu. See p.184 "Storing or Printing Received Documents".
- r You can also check and manage the documents using DeskTop-Binder V2 Lite. See p.135 "Managing Documents Saved in the Document Server from a Computer".

Reference

"Configuring the Network Interface Board using a Web Browser", *Network Guide*

Viewing, Printing, and Deleting Received Fax Messages Using a Web Browser

Use the following procedure to view and/or print received fax messages using a Web browser.

Viewing received fax messages using a Web browser

- 1** Start a Web browser.
- 2** Enter the machine's IP address in the [Address] field.
- 3** Click [Fax Received File].

With a user code programmed

- A** If you have programmed a user code, enter the code, and then press [OK].

A list of the received fax messages appears.

Note

- r If the programmed user code has been deleted using the Address Book Management function under System Settings, a message indicating incorrect user code entry appears. If this is the case, reprogram a user code. See p.186 "Setting a User Code for Viewing Received and Stored Documents".

- 4** Click the **Property** icon of the desired fax message.

Information such as reception dates, senders, line types, number of pages, and file numbers appear in addition to preview images.

 **Note**

r You can select the thumbnail display, details display, or icon display. Click **[Thumbnails]**, **[Details]**, or **[Icons]**.

- 5** View the content of the fax message.

 **Note**

r To enlarge the preview image, click **[Enlarge Image]**. Enlargement cannot be performed without Acrobat Reader installed. For more information, see Help on the Web browser.

- 6** To download the received fax message, click **[PDF]** or **[Multi-page TIFF]**.

Clicking **[PDF]** causes Acrobat Reader to be started and the message to be displayed.

Clicking **[Multi-page TIFF]** causes a downloading confirmation window to appear.

 **Note**

r The method for downloading differs depending on the selected format. For more information, see Help on the Web browser.

Printing fax information using a Web browser

- 1** Start a Web browser.

- 2** Enter the machine's IP address in the **[Address]** field.

- 3** Click **[Fax Received File]**.

The list of received fax messages appears.

- 4** Click and select the check box beside the fax message to be printed.

 **Note**

r You can select the thumbnail display, details display, or icon display. Click **[Thumbnails]**, **[Details]**, or **[Icons]**.

- 5** Click **[Print]**.

- 6** Click **[Start Print]**.

 **Note**

r To cancel printing, press **[Cancel]** before clicking **[Start Print]**.

r You can change the printing order of selected multiple messages. You can also have messages printed on both sides of paper. For more information, see Help on the Web browser.

- 7** Click **[OK]**.

The display returns to that of step **4**.

Deleting fax information using a Web browser

- 1** Start a Web browser.
- 2** Enter the machine's IP address in the [Address] field.
- 3** Click [Fax Received File].

The list of received fax messages appears.

- 4** Click and check the check box beside the fax message to be deleted.

 **Note**

r You can select the thumbnail display, details display, or icon display. Click [Thumbnails], [Details], or [Icons].

- 5** Click [Delete].

- 6** Click [Delete File].

 **Note**

r To cancel deletion, press [Cancel] before clicking [Delete File].

r After selecting multiple messages, you can also cancel deletion of some of the selected messages. For more information, see Help on the Web browser.

- 7** Click [OK].

The display returns to that of step **4**.

Viewing Received Messages on a Computer

ScanRouter V2 Professional (sold separately) is also required as a delivery server. DesktopBinder V2 Professional Lite or DesktopBinder V2 Professional software (both sold separately) must be installed on your computer.

Delivering Received Messages

Messages received by the machine can be viewed on or downloaded to a computer with the network delivery server, ScanRouter V2 Professional. This is a useful function, enabling you to view and store messages on your computer without printing them.

Using the delivery server, you can eliminate the task of retrieving and delivering messages.

6

v Functions

Delivery server provides the following functions:

- Use the delivery server to associate incoming messages (Confidential ID, SUB Code, Own Name, and Own Fax Number) with receivers, so messages are delivered to the intended receivers.
- You can select the delivery method for incoming messages: "Save in the delivery server inbox," "Send as an e-mail attachment," or "Save in the designated PC folder." Incoming messages with no Confidential ID, SUB Code, Own Name, or Own Fax Number are saved in the delivery server inbox. You can also set so that the received messages are stored in the specified delivery server inbox according to the used line for reception.

- You can check or download received messages stored in the delivery server inbox using DesktopBinder V2 Professional Lite or DesktopBinder V2 Professional.

🚫 Limitation

- r Confidential messages are also forwarded to the delivery server.

📝 Note

- r To view or download messages stored in the delivery server inbox, you need to install the separately sold DesktopBinder V2 Professional Lite or DesktopBinder V2 Professional on your computer.
- r To send received messages to your computer as e-mail attachments, you need to have a ScanRouter V2 Professional-compatible e-mail program on your computer.
- r To create a network using the delivery server, settings must be specified in the User Tools of the machine. Settings must also be specified on the delivery server. See "Settings You Can Change with User Tools - File Transfer", *Network Guide*.
- r See ScanRouter V2 Professional Help or instructions for more information on the delivery server (ScanRouter V2 Professional).
- r For information about DesktopBinder V2 Lite/Professional, see DesktopBinder V2 Lite/Professional Help or instructions.

7. Simplifying the Operation

Programs

If you regularly send messages to a particular destination or transmit using the same functions, you can save repetitive keypad operations by registering this information in a Keystroke Program.

Registering and Changing Keystroke Programs

Keystroke Programs can be recalled by just pressing a Quick Dial key. The following procedure can be used to program a new Keystroke Program or overwrite an old one.

You can register the following items in Keystroke Programs:

- Memory Transmission, Internet Fax transmission, Difference size originals, Immediate Transmission, destinations (up to 500 numbers), resolution, original type, G3 communication mode, Stamp, Send Later, Default ID, Auto Image Density, Manual Image Density, Scan Area, Auto Document, Book Fax, Polling Transmission, Polling Reception, Transfer Request, two-sided transmission, entering text, reception confirmation settings, and BCC transmission settings, optional functions
- Program name (up to 20 characters)

 **Note**

r The maximum number of programs you can register is 100 (200 with the optional fax function upgrade unit).

- r Use the same procedure to register and change programs. Follow the procedure for the items you want to change.
- r The method of registering or changing programs for the copy function is different from that of the fax function.
- r You cannot register the following using program No.1:
 - Any destination
 - Polling Transmission
 - User Transmission
 - Store File
 - Specifying a stored file
 - Enter Subject of Mail Options

1 Make sure that the machine is in facsimile mode and the standby display is shown.

 **Note**

r If the standby display is not shown, press the **[Facsimile]** key.

2 Prepare for registering the program.

 **Note**

- r The procedure for programming differs depending on the items you want to register.
- r Press the **[Clear Modes]** key to cancel programming.

Example of registering a program using Send Later with the fax number "0123456789"

- A Press [0], [1], [2], [3], [4], [5], [6], [7], [8], [9] using the number keys.
- B Perform the Send Later setting till the procedure of pressing [OK] key to return to the standby mode.

Reference

p.3 "Sending at a Specific Time (Send Later)"

3 Press the [Program] key.

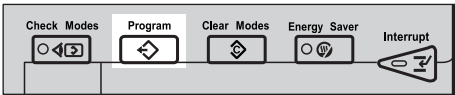

4 Make sure that [Register] is selected.



5 Select a program number in which "Not Programmed" is shown.



Note

- r If you make a mistake, press [Cancel] and select a program number again.

- r When you change a Keystroke Program, press [Register] after pressing the program number you want to change. If you make a mistake, press [Do not Register] and return to step 3.

6 Enter the program name, and then press [OK].

The standby display appears.

Note

- r If you make a mistake, press [Backspace] or [Delete All], and then try again.
- r You should register the program name.
- r To cancel a programmed program, press [Cancel]. The display returns to that of step 3.

Reference

"Entering Text", *General Settings Guide*

Registering a priority function using a program

You can select whether or not the function registered in program No. 1 will be set after the power is turned on or the [Clear Modes] key is pressed.

After registering a function in program No. 1, select [Program No.1] for [Change Initial Mode] on the Facsimile Features menu. See p.142 "General Settings/Adjustment".

Note

- r For this purpose, program No.1 does not allow you to program destinations, Polling Transmission, User Transmission, Store File, Scan Area, resolution, Image Density and Send Stored-file functions.

Changing a program name

- 1 Make sure that the machine is in facsimile mode and the standby display is shown.

Note

If the standby display is not shown, press the **[Facsimile]** key.

- 2 Press the **[Program]** key.

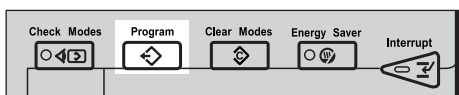

- 3 Press **[Change Name]**.



- 4 Select the program number of the name you want to change.



- 5 Enter a new program name, and then press **[OK]**.

Note

Press **[Cancel]** to cancel the change, and proceed to step 6.

- 6 Press **[Exit]**.

The standby display appears.

Deleting a Program

- 1 Make sure that the machine is in facsimile mode and the standby display is shown.

Note

If the standby display is not shown, press the **[Facsimile]** key.

- 2 Press the **[Program]** key.

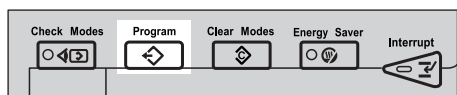

- 3 Press **[Delete]**.

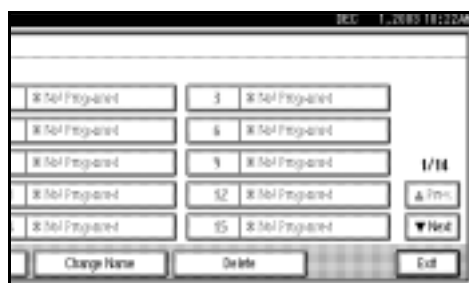

- 4 Select the program number you want to delete.



- 5 Press **[Yes]**.

Note

Press **[No]** not to delete the program. The display returns to that of step 3.

- 6 Press **[Exit]**.

The standby display appears.

Using a Program

Note

r Using the program causes the previous settings to be cleared.

Example of executing a program using Send Later with the fax number "0123456789"

1 Make sure that the machine is in facsimile mode and the standby display is shown.

Note

r If the standby display is not shown, press the **[Facsimile]** key.

2 Place the original.

Note

r If you have no programmed destinations or scan settings as programs, enter the fax number of the destination and select the scan settings you require.

3 Press the **[Program]** key.

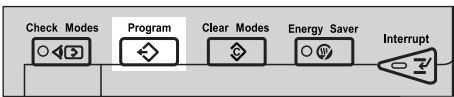

4 Select the program number you registered.



The standby display appears.

Then, the programmed fax number is shown. Transmission Mode is selected.

5 Press the **[Start]** key.

The fax number and specified time are shown on the display, and the machine starts to scan the original.

Transmission will start at the specified time.

Using the Document Server

Use this function to store documents in the Document Server on this machine.

The Document Server can store documents from various applications.

The documents that are stored using the facsimile function are available to transmit by facsimile.

Storing in the Document Server enables the following:

- Once stored, a document can be sent out as many times as you want, just by selecting it.
- Storing a document does not use facsimile memory.

You can send and print multiple stored documents as a single document, and also send them with scanned originals at the same time. Follow the instructions under **[Select Stored File]** in **[Sub TX Mode]** when sending or printing stored documents. See p.67 "Sending a Stored File".

Reference

"What You Can Do with This Machine", *General Settings Guide*

Important

- r Data stored in the machine might be lost if some kind of failure occurs. The manufacturer shall not be responsible for any damage that might result from the loss of data.

Note

- r Stored documents are not deleted even when there is a power failure, or the main power switch is turned off.

- r You can specify whether or not the machine automatically deletes documents from the Document Server after a certain number of days. The delete function is pre-configured with the software and automatically deletes any stored document that is more than three days (72 hours) old. You can change the setting with "Auto Delete File" under "Key Operator Tools". See "Key Operator Tools — Auto Delete File", *General Settings Guide*.
- r You can store approximately 9,000 pages (ITU-T No.4 chart) in the Document Server, using the copy, facsimile, printer, and scanner functions.
- r The fax feature has a memory capacity of approximately 3,000 documents.
- r You can store up to 1,000 pages per document.
- r You cannot check received and stored documents through the Document Server. See p.34 "Printing Received and Stored Documents".

Storing a Document

You can store and send a document at the same time. You can also just store a document.

v File names

Scanned documents are automatically assigned names like "FAX0001" or "FAX0002". See p.131 "Setting a file name".

v User Names

You can set this function if necessary to know who and what departments stored documents in the machine. See p.131 "Programming a user name".

v Password

You can set this function so as not to send to unspecified people. See p.131 "Setting a password".

Note

r You can change file names and user names. See p.132 "Changing Information of Stored Documents".

1 Make sure that the machine is in facsimile mode and the standby display is shown.

If the standby display is not shown, press the **[Facsimile]** key.

2 Place the original, and then select the scan settings you require.

Reference

p.15 "Placing Originals", *Facsimile Reference* <Basic Features>

p.33 "Scan Settings", *Facsimile Reference* <Basic Features>

3 Press **[Store File]**.

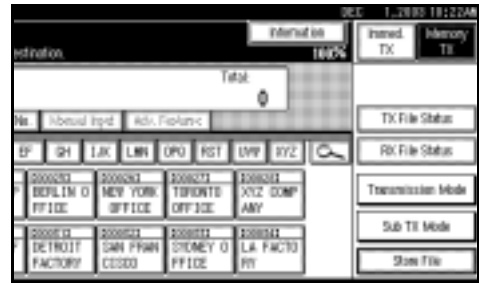

4 Select **[Store & Transmit]** or **[Store only]**.

Select **[Store & Transmit]** to send documents after they are stored.

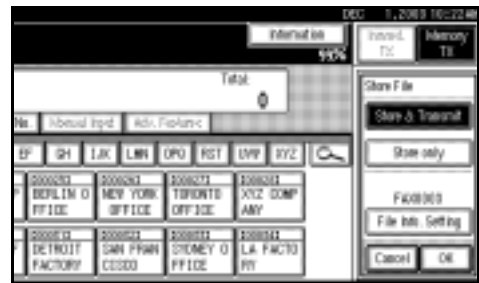

Select **[Store only]** to store documents.

When **[Store only]** is selected, "XXXXXXXXXXXX" is shown.

5 Press **[File Info. Setting]**, and then set the user name, file name, and password as necessary.

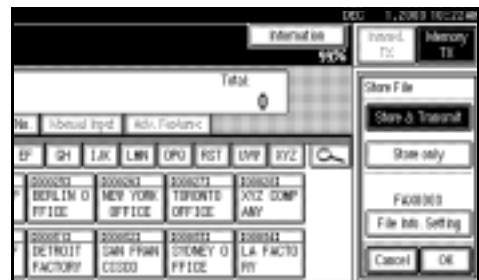

Note

r If you are not setting a user name, file name, or password, proceed to step 6.

r You cannot change multiple documents at once.

Programming a user name

Note

- Set a user name from those programmed in the user code. User code is programmed in System Settings. See *General Settings Guide*.

A Press [User Name].

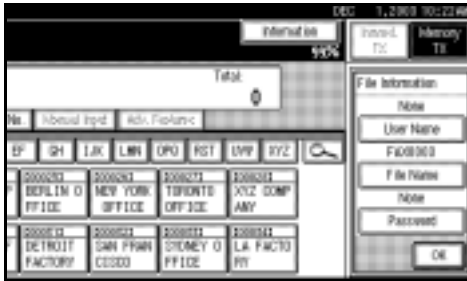

- Press the user name to be programmed, and then press [OK].

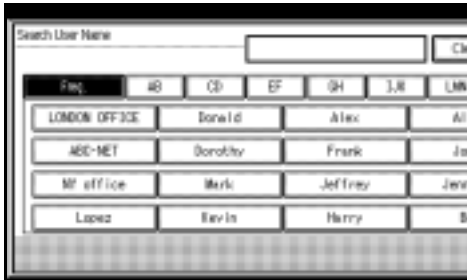

Note

- Press the title key to switch between titles.
- To set a non-programmed user name, press [Non-programmed Name], and then enter the name. User names entered by pressing [Non-programmed Name] are not programmed into the user code.

Reference

“Entering Text”, *General Settings Guide*

- Press [OK].

Setting a file name

A Press [File Name].

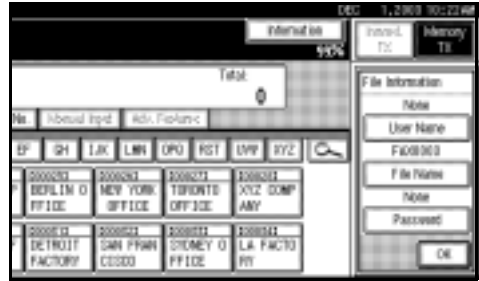

- Enter the file name, and then press [OK].

Reference

“Entering Text”, *General Settings Guide*

- Press [OK].

Setting a password

A Press [Password].

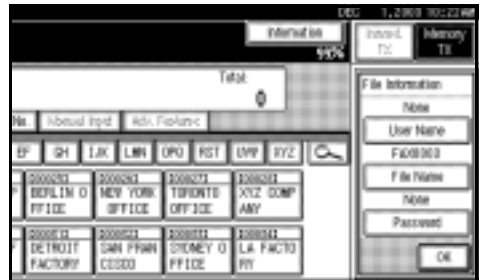

- Enter a password using the number keys, and then press [#].



Note

- r If you make a mistake, press **[Clear]** or the **[Clear/Stop]** key before pressing **[OK]**, and then reenter your password.
- r You can enter up to four digits.

C Enter the password again, and then press [#].

D Press [OK].

Note

- r Press **[Change]** to enter a different password.

E Press [OK].

6 Press **[OK]**.

7 If you have selected **[Store & Transmit]**, specify the receiver.

Note

- r If you have selected **[Store only]**, proceed to step **8**.

8 Press the **[Start]** key.

Changing Information of Stored Documents

You can change the file name, user name, and password of stored documents.

To change a stored document, delete the document you no longer need, and then reprogram the new document. See p.134 "Deleting a Stored Document".

Note

- r You can program one of the Quick Operation keys with operations for this function. Using the key allows you to omit steps **1** and **2**.

1 Press **[Sub TX Mode]**.

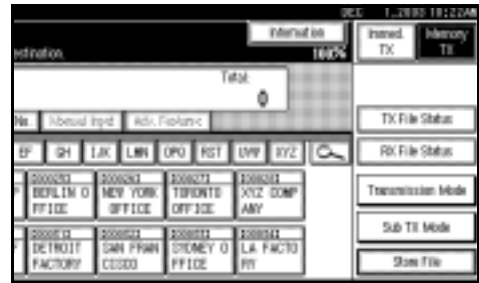

2 Select **[Select Stored File]**.

3 Select **[Manage/Delete File]**, and then press the document to be changed.



- 4** If you select a document for which a password is set, enter the password, and then press **[OK]**.

When a selected file does not have a password, proceed to step **5**.

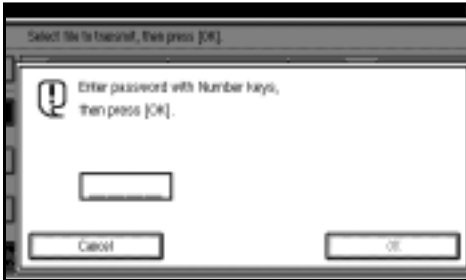

- 5** Change the desired information of the stored document.

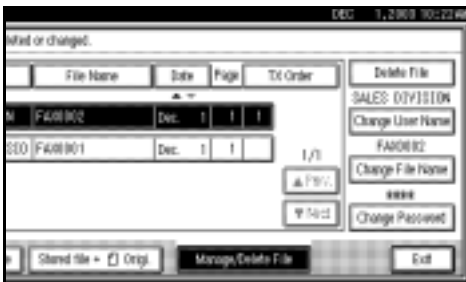

Changing a user name

- A Press **[Change User Name]**.
B Press **[Clear]**.

The user name is deleted.



- C Enter the new user name, and then press **[OK]**.

Note

- r Press the title keys to switch between titles.
- r To set a non-programmed user name, press **[Non-programmed Name]**, and then enter the name.
- r User names entered by pressing **[Non-programmed Name]** are not programmed into the user code.

Reference

"Entering Text", *General Settings Guide*

Changing the file name

- A Press **[Change File Name]**.
B Press **[Backspace]** or **[Delete All]**, and then re-enter the file name.



Reference

"Entering Text" *General Settings Guide*

- C Press **[OK]**.

Changing the password

- A Press **[Change Password]**.
B Press upper **[Change]**.

- C Enter a new password using the number keys, and then press [#].



- D Press lower [Change].
- E Enter the password again, and then press [#].
- F Press [OK].

- 6 Press [Exit].

- 7 Press [OK].

The standby display appears.

Deleting a Stored Document

Use this function to delete stored documents.

Note

- r You can program one of the Quick Operation keys with operations for this function. Using the key allows you to omit steps 1 and 2.

- 1 Press [Sub TX Mode].

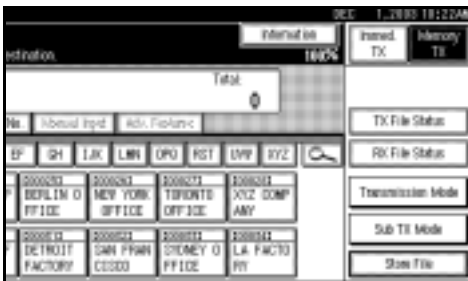

- 2 Press [Select Stored File].

- 3 Press [Manage/Delete File].



- 4 Select the document you want to delete.



Note

- r You can also delete multiple documents at once.

With a programmed password

- A Enter a password using the number keys, and then press [OK].

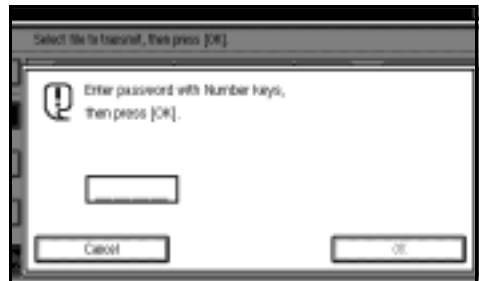

- 5 Press [Delete File].

- 6 Press [Delete].

Note

- r If you do not want to delete the document, press [Do not Delete].

7 Press [Exit].

8 Press [OK].

The standby display appears.

Managing Documents Saved in the Document Server from a Computer

Using DesktopBinder

Fax documents saved in the Document Server can be viewed and controlled from a network computer with DesktopBinder V2 Lite or DesktopBinder V2 Professional installed.

The following operations are available using the computer:

- Displaying documents (Easy Viewer)
- Displaying document properties (Properties)
- Deleting documents (Delete)
- Copying documents to a computer (Copy)
- Printing documents (Print from Document Server)
- Exporting documents as files (Export Document)

For more information, see DesktopBinder V2 operating instructions and Help.

 **Note**

r Settings made in System Settings enable you to send documents to the delivery server. See “Setting up the Machine on a Network”, *Network Guide*.

Using a Web browser

Fax documents saved in the Document Server can be viewed using a Web browser on a network computer. These fax documents can also be downloaded to the computer's hard disk. See p.121 “Viewing Fax Information Using a Web Browser”.

8. Facsimile Features

Function List

The User Tools allow you to program your identification, store frequently used numbers and settings, and customize default settings to meet your needs.

The User Tools are grouped by functions so that you can quickly and easily find the desired User Tool.

v General Settings /Adjustment

Description	Reference
<p>Default Transmission Mode and scan settings. When the power is turned on, settings specified here are selected:</p> <ul style="list-style-type: none">• Memory/Immediate Transmission Switch• Text Size Priority• Original Type Priority• Auto Image Density• Adjust Scan Density• Select Title• Change Initial Mode• Adjust Sound Volume• Program Fax Information• Scan End Reset• Transmission Stamp Priority• Line Priority Setting• Program Economy Time• On Hook Mode Release Time• Quick Operation key	p.142 "General Settings/ Adjustment"

v Reception Settings

Description	Reference
<p>Allows you to switch the following reception functions on or off:</p> <ul style="list-style-type: none"> • Switch Reception Mode • Authorized Reception See p.167 "Authorized RX (Authorized Reception)". • Forwarding See p.167 "Forwarding". • Reception File Print Quantity See p.167 "Reception File Print Qty". • Two-Sided Print See p.97 "Two-Sided Printing". • Reception Reverse Printing See p.100 "Reverse Order Printing". • Paper Tray See p.168 "Paper Tray". • Specify Tray for Lines See p.105 "Specifying Tray for Lines". • Checkered Mark See p.96 "Checkered Mark". • Center Mark See p.96 "Center Mark". • Print Reception Time See p.97 "Reception Time". 	p.144 "Reception Settings"

v E-mail Settings

Description	Reference
<ul style="list-style-type: none"> • Internet Fax Settings • Maximum E-mail Size • SMTP Reception File Settings 	p.145 "E-mail Settings"

v Key Operator Tools

Description	Reference
<ul style="list-style-type: none"> • Program/Change/Delete Standard Message • Store/Change/Delete Auto Document • Program/Change/Delete Scan Size • Print Journal • Transmission Page Count • Forwarding • Memory Lock Reception • ECM • Parameter Setting • Program Special Sender • Box Setting • Transfer Report • Program Confidential ID • Program Polling ID • Program Memory Lock ID • Select Dial/Push Phone • Reception File Setting • Stored Reception File User Code Setting 	p.147 "Key Operator Setting"

Displays

- Each menu appears in each tab.
- You can switch the display by pressing [**▲ Prev.**] or [**▼ Next**].
- The selected item is highlighted.
- When you have made all required settings, press [**OK**]. If [**OK**] is not pressed, the new settings might be canceled.
- Press [**Cancel**] to cancel the new settings. The previous display appears.

 **Key Operator Code**

When Key Operator Code is programmed and turned on, users have to enter a programmed Key Operator Code (eight digits maximum) to operate the User Tools. This prevents unauthorized people from changing settings.

 **Note**

- r You can turn the Key Operator Code on or off in “User Tools Menu (System Settings)”, *General Settings Guide*.
 - r When you set the Key Operator Code to active, enter a code (eight digits maximum) using the number keys and select **[Partial]** or **[All Initial Settings]** to limit access.
 - When **[Partial]** is selected:
Only Key Operator Tools are protected with a Key Operator Code.
 - When **[All Initial Settings]** is selected:
Key Operator Tools and User Tools are protected with a Key Operator Code.
- ① Press the **[User Tools/Counter]** key.
 - ② Press **[Facsimile Features]**.
If you have selected **[All Initial Settings]**, proceed to step ④.
 - ③ Press **[Key Operator Tools]**.
 - ④ Enter a Key Operator Code (eight digits maximum) using the number keys.

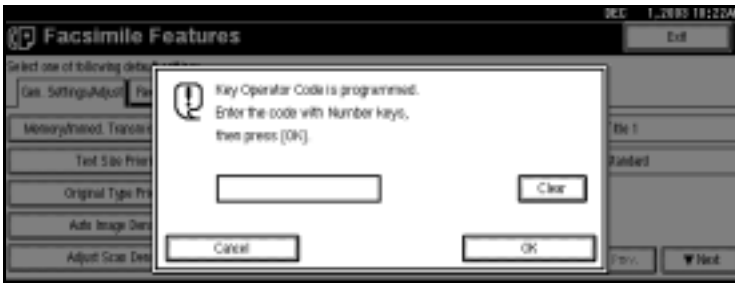

- ⑤ Press **[OK]**.

 **Note**

- r If you enter a Key Operator Code not programmed, the display will return to that of step ④.

Accessing User Tools (Facsimile Features)

Customize the facsimile settings according to the operations to be frequently performed.

Note

The machine allows you to change the facsimile defaults in a mode that is not the facsimile mode. After changing the defaults, select facsimile mode again. This section describes the facsimile defaults that the machine allows you to customize.

Customized facsimile defaults are kept until the defaults are changed again. The new settings are not cancelled by turning off the main power switch or the Operation switch or pressing the **[Clear Modes]** key.

Reference

For the items that can be changed using System Settings, see "User Tools (System Settings)", *General Settings Guide*.

1 Press the **[User Tools/Counter]** key.

The main menu display for default settings appears.

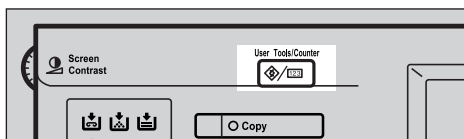

Note

With a Key Operator Code programmed, changing the default causes the Key Operator Code entry display to appear. If this happens, enter the programmed code first. For the Key Operator Code, see the *General Settings Guide*.

2 Press **[Facsimile Features]**.

The menu display for facsimile default settings appears.

3 Select the item that you want to change.

The corresponding setting display appears.

Reference

p.137 "Function List"

4 Follow the displayed instructions to change the default, and then press **[OK]**.

Note

If you make a mistake, press **[Cancel]**.

Quitting Default Settings

1 After changing the defaults, press **[Exit]** on the main menu display for default settings.

The standby display appears.

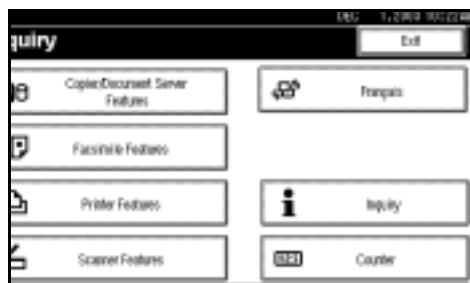

Note

You can also press the **[User Tools/Counter]** key to quit the main menu display for default settings.

General Settings/Adjustment

v **Memory/Immed. Transmission Switch**

Use this function to specify the Transmission Mode for document transmission.

- Memory Transmission
- Immediate Transmission

v **Text Size Priority**

Use this function to specify the character size of your originals for scanning.

- Standard
- Detail
- Super Fine (expansion memory required)

v **Original Type Priority**

Use this function to specify the type of originals for scanning.

- Text
- Text/Photo
- Photo

v **Auto Image Density**

Use this function to prioritize automatic Image Density for scanning your originals.

- ON
- OFF

v **Adjust Scan Density**

Use this function to specify the scan density of your originals.

v **Select Title**

Use this function for selecting the title to be shown on the destination list.

- Title 1
- Title 2
- Title 3

v **Change Initial Mode**

Use this function to select whether contents registered in program No.1 are to be used as the initial settings after the power is turned on or the **[Clear Modes]** key is pressed:

- Standard
- Program No.1

Note

r You cannot select Program No.1 if program No.1 has not been programmed with priority functions.

v **Adjust Sound Volume**

See p.75 "Adjusting the Volume", *Facsimile Reference <Basic Features>*.

- On Hook Mode
- At Transmission
- At Reception
- At Dialing
- At Printing

v **Program Fax Information**

See p.67 "Initial Settings and Adjustments", *Facsimile Reference <Basic Features>*.

- Fax Header
- Own Name
- Own Fax Number

v **Scan End Reset**

Use this function to return to the initial settings each time an original is scanned.

- ON
- OFF

v **TX Stamp Priority**

Use this function to press a TX stamp.

- ON
- OFF

v **Line Priority Setting**

Use this function to specify the line of usage.

 **Note**

r The display may differ depending on the line type you have.

v **Program Economy Time**

Use this function for specifying a time for transmission when call charges are low. See p.3 “Sending at a Specific Time (Send Later)”.

 **Limitation**

r You can program only one Economy Time.

 **Note**

r If you make a mistake, press **[Clear]** or the **[Clear/Stop]** key before pressing **[OK]**, and then try again.

v **On Hook Mode Release Time**

Use this function to specify a time to cancel On Hook mode after you transmit using On Hook dialing.

- 1 minute
- 3 minutes
- 5 minutes
- 10 minutes

v **Quick Operation Key**

Frequently used functions programmed as Quick Operation keys are shown on the menu immediately after the power is turned on. The Quick Operation keys can be programmed with the following functions:

- Journal
- TX File Status (Transmission File Status)
- Print Conf. RX (Print Confidential Reception)
- Print Memory Lock

- Stored File
- Send Later
- Auto Document
- 2 Sided Original
- Closed Network
- Polling TX (Polling Transmission)
- Polling RX (Polling Reception)
- Fax Header Print
- Label Insertion
- RX File Status (Reception File Status)
- Forwarding
- Transfer Request
- Switch RX Mode (Reception Mode Switch)
- Manual E-mail RX (Manual E-mail Reception)
- TX Status Report (Transmission Status Report)
- User TX (User Transmission)
- E-mail TX Results (E-mail Transmission Results)

Up to three functions can be programmed into a Quick Operation keys.

A Select Quick Operation key you want to program.

B Select the function you want to program in the Quick Operation key

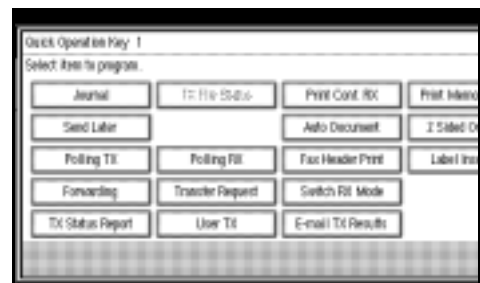

 **Note**

r Functions that appear dimmed have already been set.

Reception Settings

- ▼ **Switch Reception Mode**
Specify the method for receiving fax messages.

 - Manual Reception
 - Auto Reception
- ▼ **Authorized RX (Authorized Reception)**
Specify whether or not unwanted fax messages are to be screened out.

 - ON
 - OFF
- ▼ **Forwarding**
Specify whether or not received fax messages are to be forwarded to a programmed receiver.

 - ON
 - OFF
- ▼ **RX File Print Qty (Reception File Print Quantity)**
Specify the number of copies to be printed for each fax message received.

 - 1 to 10 set(s)
- ▼ **2 Sided Print (Available only with the optional duplex unit)**
Specify whether or not received fax messages are to be printed on both sides of paper.

 - ON
 - OFF
- ▼ **RX Reverse Printing (Reception Reverse Printing)**
Specify whether or not received fax messages are to be printed from the last page received.

 - ON
 - OFF

- ▼ **Paper Tray**
Use this function to print fax messages received from programmed senders and fax messages from other senders, using different paper trays.
Display of tray names may differ depending on the options installed.

 - Tray 1
 - Tray 2
 - Tray 3 (option)
 - Tray 4 (option)
 - Auto Select
 - LCT (option)
- ▼ **Specify Tray for Lines**
Specify a paper tray for each line (telephone/LAN).

 - OFF
 - ON

① Select **[ON]** to select a paper tray.

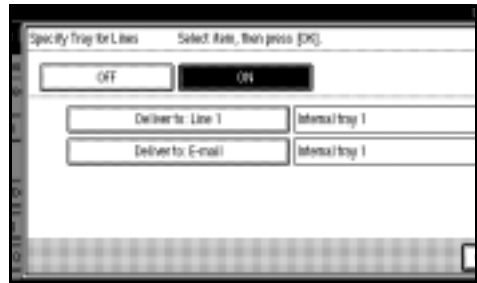

Note

r If you select **[OFF]**, the received fax is delivered to a default tray.

- ② Select the line type.

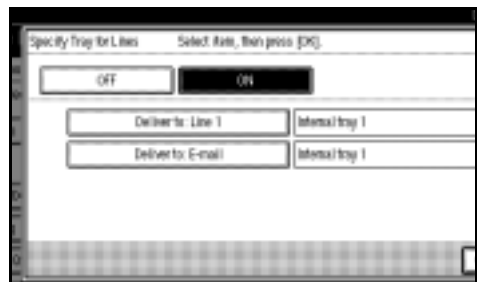

- ③ Select a tray to deliver the received paper onto, and then press **[OK]**.



Note

- r If you want to specify another line type, repeat from step ②.

v Checkered Mark

Specify whether or not a checkered mark is to be printed on the first page of received fax messages.

- ON
- OFF

v Center Mark

Specify whether or not a center mark is to be printed halfway down the left side and at the top center of each page received.

- ON
- OFF

v Print Reception Time

Specify whether or not received date and time are to be printed at the bottom of received fax messages.

- ON
- OFF

E-mail Settings

v Internet Fax Setting

You can select to display  or not. When you want to send an Internet Fax, set ON to display the icon.

- ON
- OFF

v Max. E-mail Size

Make this setting when you want to limit the size of e-mail messages that are transmitted, if receivers limit e-mail size, or you cannot send large size e-mail for some reason. When this function is set to on, transmission of e-mail that exceeds the set size is aborted.

- ON
- OFF

Note

- r When e-mail exceeds the maximum file size, an Error Report is output, and the e-mail is deleted.
- r Even when e-mail does not exceed the size limit, it may be rejected if it does not meet the requirements of the server settings.

- ① Press **[ON]**

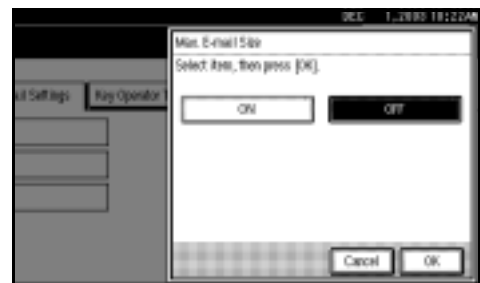

- ② Enter the maximum e-mail size using the number keys.

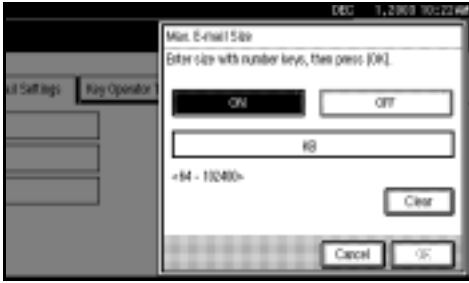

Note

r Maximum e-mail size can be between 64 and 102400 KB.

- ③ Press [OK]

v **SMTP RX File Delivery Settings (SMTP Reception File Delivery Settings)**

This function is available on systems that allow routing of e-mail received via SMTP. See p.94 "Routing E-mail Received via SMTP".

- On
- Off

When an authorized e-mail address is set, e-mail received from addresses that do not match the authorized address is discarded, and an error message is returned to the SMTP server.

The authorized e-mail address is compared with the addresses of e-mail originators, as illustrated by the following examples.

When the authorized e-mail address is set to "@aaa.abcd.com":
 abc@aaa.abcd.com - accepted
 def@aaa.xyz.com - not accepted
 abc@abcd.com - not accepted

Note

r No Error Report is output even when e-mail is discarded.

- ① Press [On].



- ② Press [Change], and then enter the sending e-mail address with transmission permission.

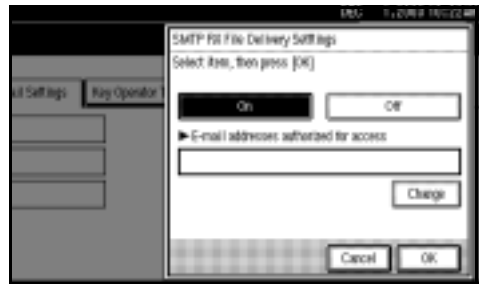

Note

r If you make a mistake, press [Backspace] or [Delete All], and then enter again.

- ③ Press [OK] twice.

9. Key Operator Setting

Key Operator Tools List

You can program, change, or delete standard messages and auto documents. You can also set the line type for the machine connection, program various IDs (including a Polling ID), fax destinations, and many other items. In addition, you can check the number of documents transmitted and received.

Function name	Description	Reference
Program/Change/Delete Standard Message	You can program, change, or delete standard messages printed at the top of the first page of each incoming message.	p.149 "Programming, Changing, and Deleting Standard Messages"
Store/Change/Delete Auto Document	You can program, change, or delete pages stored as auto documents.	p.149 "Programming, Changing, and Deleting Standard Messages"
Program/Change/Delete Scan Size	You can program, change, or cancel frequently used scan sizes.	p.152 "Programming, Changing and Deleting a Scan Size"
Print Journal	Prints a Journal.	p.154 "Printing the Journal"
Transmission Page Count	Checks the transmission and reception, and totals on the display.	p.154 "Counters"
Forwarding	Transfers received messages to a programmed receiver (forwarding destination).	p.155 "Forwarding"
Memory Lock RX	Switches the Memory Lock to on or off. To use it, program an ID for printing a message received in Memory Lock mode.	p.157 "Memory Lock"
ECM	If part of the transmission fails due to a telephone line fault, this function resends the failed part automatically.	p.158 "ECM"
Parameter Setting	Allows you to change and print the function settings to meet your needs.	p.159 "User Parameters"
Program Special Sender	By programming particular receivers as Special Sender in advance, you can have Special Senders treated differently.	p.166 "Programming/ Changing Special Senders"

Function name	Description	Reference
Box Setting	By using SUB and SEP Codes with these functions, you can send messages to another party's box, and retrieve messages stored in boxes.	p.172 "Box Settings"
Transfer Report	Before using Transfer Request, you need this Transfer Report setting.	p.181 "Transfer Report"
Program Confidential ID	Registers an ID required for Confidential communication.	p.182 "Programming a Confidential ID"
Program Polling ID	Registers an ID required for Polling communication.	p.183 "Programming a Polling ID"
Program Memory Lock ID	Registers an ID required for Memory Lock reception.	p.183 "Programming a Memory Lock ID"
Select Dial/Push Phone	Selects a line type when you connect the machine to a G3 analog line.  Note r This function is not available in some areas.	p.184 "Selecting Dial/Push Phone"
Reception File Setting	Selects whether received documents are saved on the hard disk to be printed later or printed immediately without being saved.	p.184 "Storing or Printing Received Documents"
Stored RX File User Code Setting	Set the password to view received and stored documents using a Web browser or DesktopBinder V2 Lite.	p.186 "Setting a User Code for Viewing Received and Stored Documents"

Using Key Operator Settings

Programming, Changing, and Deleting Standard Messages

Use this function to program standard messages to be printed at the top of the first page of the original. It is useful for personalizing messages such as sending greetings.

Note

- r You can program three standard messages. You cannot change the “Confidential”, “Urgent”, “Please phone”, or “Copy to corres. section” messages.
- r Use the same procedure to program and change your messages.

1 Press the **[User Tools/Counter]** key.

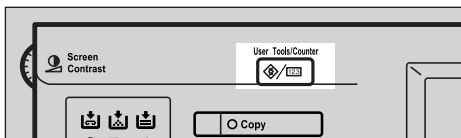

2 Press **[Facsimile Features]**.

3 Press **[Key Operator Tools]**.

4 Press **[Program/Change/Delete Standard Message]**.

Programming or changing standard messages

A Select the message number key you want to program or change.



B Enter a new message.

Reference

“Entering Text”, *General Settings Guide*

C Press **[OK]**.

Note

- r To program another message, repeat the procedure from step A.
- r To cancel a registration, press **[Cancel]**.

Deleting Standard Messages

A Press **[Delete]**, and then select the message you want to delete.



B Press [Delete].**Note**

- r To delete another message, repeat from step A.
- r To cancel a deletion, press **[Do not Delete]**. The display returns to that of step A.

5 Press [Exit].**6 Press the [User Tools/Counter] key.**
The standby display appears.

Storing, Changing, and Deleting an Auto Document

If you often have to send a particular page to people (for example, a map, a standard attachment, or a set of instructions), you can store that page in memory as an Auto Document. This saves rescanning the original every time you want to send it.

Use the following procedure to program a new Auto Document or overwrite an existing one.

You can store the following items in an Auto Document:

- Originals (6 documents maximum; when the optional fax function upgrade unit is installed, 18 documents maximum, only one page per file).
- Scan settings (resolution, original type, and image density)
- Irregular scan area
- Document name (16 characters maximum)

Important

- r When about one hour passes after power of the machine is turned off, all fax messages stored in memory are lost. If any messages have been lost for this reason, a Power Failure Report is automatically printed when the operation switch is turned on. Use this report to identify lost messages.

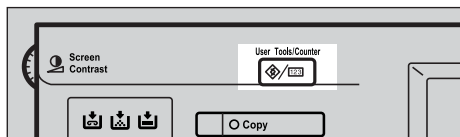
1 Press the [User Tools/Counter] key.**2 Press [Facsimile Features].****3 Press [Key Operator Tools].****4 Press [Store/Change/Delete Auto Document].****5 Select and follow the appropriate procedure depending on what you want to perform.****Note**

- r If there are stored files, the file names are shown.

Storing a file

- A Select [***Not Programed**].
- B Enter a file name, and then press [**OK**].

 **Reference**

“Entering Text”, *General Settings Guide*

Changing a file

- A Select the file you want to change.

The “A file is already stored. If another file is stored, previous one will be deleted. Is it OK?” message is shown.

- B Press [**Store**].

If you want to cancel storing, press [**Do not Store**].

Changing only a file name

- A Press [**Change Name**].
- B Select the file whose name you want to change.
- C Enter a file name, and then press [**OK**].

 **Reference**

“Entering Text”, *General Settings Guide*

Proceed to step **3**.

- 6** Place the original, and then select any scan settings you require.



 **Note**

- r You can also specify a scan size. See p.18 “Setting a Scan Area”, *Facsimile Reference <Basic Features>*.

- 7** Press the [**Start**] key.

The machine starts to scan and completes scanning.

 **Note**

- r To cancel scanning, press [**Stop Scanning**].

- 8** Press [**Exit**].

- 9** Press the [**User Tools/Counter**] key. The standby display appears.

Deleting an Auto Document

 **Note**

- r You cannot delete an Auto Document waiting to be transmitted. Delete it after the transmission or cancel the transmission, and then delete the Auto Document.

- 1** Press the [**User Tools/Counter**] key.

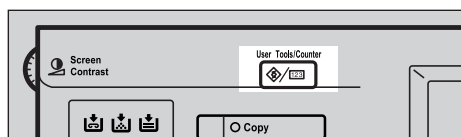

- 2 Press [Facsimile Features].
- 3 Press [Key Operator Tools].
- 4 Press [Store/Change/Delete Auto Document].
- 5 Press [Delete], and then select the file you want to delete.

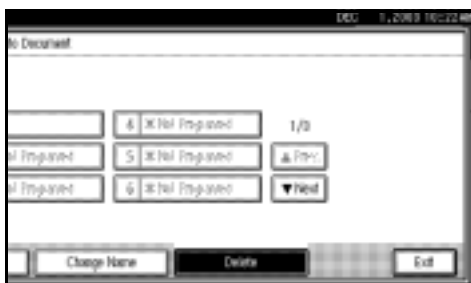

- 6 Press [Delete].

 **Note**

- r To cancel deleting, press [Do not Delete]. The display returns to that of step 5.

- 7 Press [Exit].

- 8 Press the [User Tools/Counter] key.

The standby display appears.

Programming, Changing and Deleting a Scan Size

When you select a scan size to scan a non-standard size original, two custom sizes are available (Program Size 1 and Program Size 2). Use these functions to program a custom size in advance.

To change an existing scan size, just use the same procedure.

Important

- r When programming or changing a scan size, we recommend you make a record of the new size.

Note

- r You can program up to two sizes.
- r You can specify a horizontal length from 128 to 1,200 mm, or from 5.5 to 47 inches.

- 1 Press the [User Tools/Counter] key.

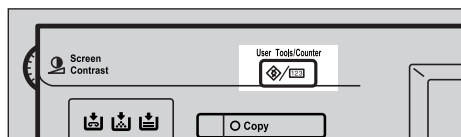

- 2 Press [Facsimile Features].

- 3 Press [Key Operator Tools].

- 4 Press [Program/Change/Delete Scan Size].

- 5** Select **[Program Size 1]** or **[Program Size 2]**.

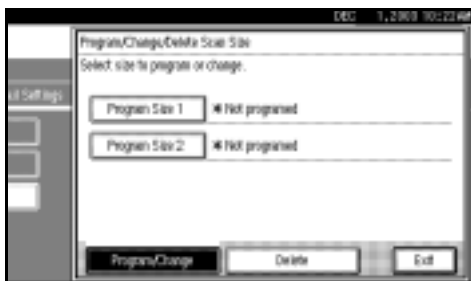

- 6** Enter a horizontal size using the number keys.

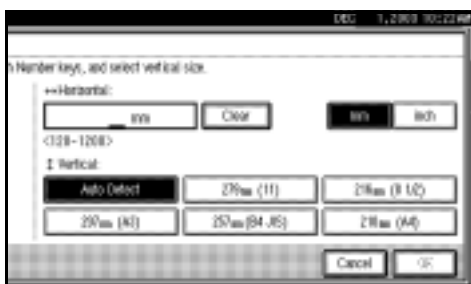

Note

- r Each time you press **[mm]** or **[inch]**, the units switch between “mm” and “inch”. If you enter a length and change the units by pressing **[mm]** or **[inch]**, the length is converted automatically according to the unit (fractions are rounded off). For example, when you enter **[2]**, **[2]**, and **[0]** in millimeters and change to “inch”, the length “8.7 inch” is shown on the display. If you press **[mm]** or **[inch]** again, “221 mm” is displayed.
- r If you make a mistake, press **[Clear]** or the **[Clear/Stop]** key, and then try again.
- r To cancel a scan size, press **[Cancel]**.

- 7** Select a vertical size, and then press **[OK]**.



Note

- r A displayed vertical size differs depending on the selected unit. When **[mm]** is selected, **[Auto Detect]**, **[210mm (A4)]**, **[257mm (B4 JIS)]**, **[297mm (A3)]**, **[216mm (8 1/2)]**, and **[279mm (11)]** are shown. When **[inch]** is selected, **[Auto Detect]**, **[8.3inch (A4)]**, **[10.1inch (B4 JIS)]**, **[11.7inch (A3)]**, **[8.5inch]**, and **[11.0inch]** are shown.
- r To cancel a scan size, press **[Cancel]**.

- 8** Press **[Exit]**.

- 9** Press the **[User Tools/Counter]** key.
The standby display appears.

Deleting a scan size

- 1** Press the **[User Tools/Counter]** key.

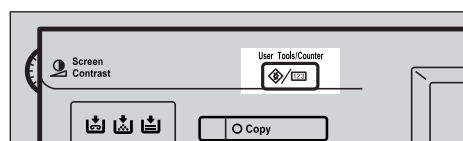

- 2** Press **[Facsimile Features]**.

- 3** Press **[Key Operator Tools]**.

- 4** Press **[Program/Change/Delete Scan Size]**.

- 5** Press **[Delete]**, and then select **[Program Size 1]** or **[Program Size 2]**.

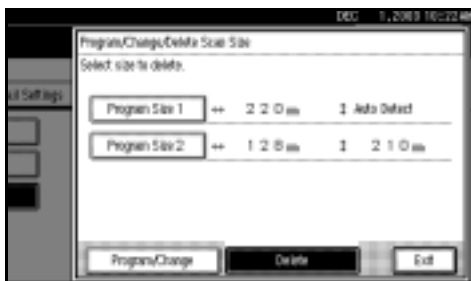

- 6** Press **[Yes]**.

Note

- To cancel deleting, press **[No]**. The display returns to that of step **5**.

- 7** Press **[Exit]**.

- 8** Press the **[User Tools/Counter]** key. The standby display appears.

Printing the Journal

The Journal allows you to check a maximum of the last 50 communications (receptions & transmissions) performed by the machine. You can print the Journal using the Information menu. See p.27 “Printing the Journal”.

Counters

This function allows you to check the total number of pages transmitted and received on the display.

- **Transmissions:**
Total number of transmitted pages
- **Receptions:**
Total number of received pages

- 1** Press the **[User Tools/Counter]** key.

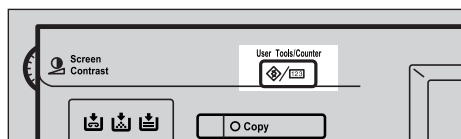

- 2** Press **[Facsimile Features]**.

- 3** Press **[Key Operator Tools]**.

- 4** Press **[Transmission Page Count]**.

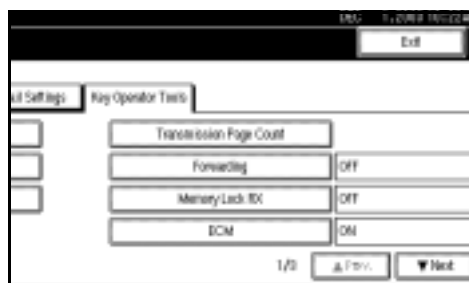

- 5** After checking the display, press **[Exit]**.

- 6** Press the **[User Tools/Counter]** key. The standby display appears.

Forwarding

This function allows you to have messages printed on the machine, and sent to a specified End Receiver.

This is useful if, for example, you are visiting another office and would like a copy of your messages to be sent to that office.

Preparation

To use this function, set Forwarding under Reception Settings to ON (enable). See p.144 “Reception Settings”

Limitation

- r The Forwarding function does not forward messages received with Confidential Reception, Memory Lock, Polling Reception mode, or messages received by Transfer Request.
- r You can select end receivers only from among destinations programmed in the Address Book. You cannot specify programmed transfer stations as end receivers.

Note

- r An e-mail address can be set as the forwarding destination.
- r If you do not program an End Receiver, the machine performs printing but not forwarding even with the Forwarding function On.
- r You can program one of the Quick Operation keys with operations for this function. You can then switch the function on or off merely by pressing the Quick Operation key. The function is on when the Quick Operation key has been highlighted.

- r If you want to change End Receivers separately according to senders, specify End Receivers for each special sender in “Special Senders to Treat Differently”. You can program one receiver per Special Sender. Received messages from unspecified senders will be forwarded to the End Receiver specified here. See p.163 “Special Senders to Treat Differently”.
- r One receiver only can be specified using this function. For multiple receivers, use Group Dial.
- r You can specify whether or not to print forwarded messages. See p.159 “User Parameters” (switch 11, bit 6).
- r Deleting a destination specified as an end receiver from the Address Book causes the settings for the end receiver to be deleted. If this is the case, reprogram the end receiver. If the destination has been changed, a message is transmitted to the new destination.
- r You can program one of the Quick Operation keys with operations for this function.

Programming an End Receiver

- 1** Press the [User Tools/Counter] key.

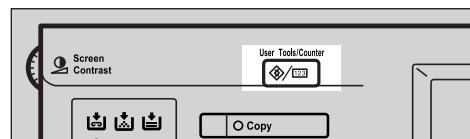

- 2** Press [Facsimile Features].
- 3** Press [Key Operator Tools].
- 4** Press [Forwarding].

5 Press [ON].**Note**

- r If there is an End Receiver already programmed, a receiver name is shown. If you want to change the receiver, press [Receiver] and proceed to step 6.
- r To cancel Forwarding, press [Cancel] and proceed to step 8.

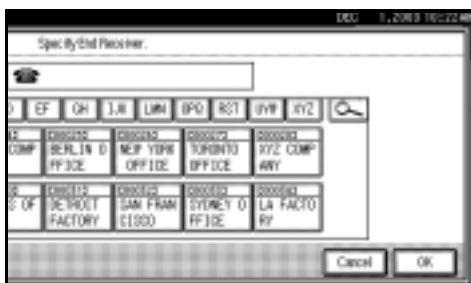
6 Specify an End Receiver using the destination list, and then press [OK].

The receiver name is shown to the right of [Receiver].

Note

- r Pressing  to switch the destination between fax number and e-mail address.

7 Press [OK].**8** Press the [User Tools/Counter] key.

The standby display appears.

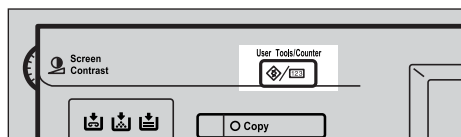
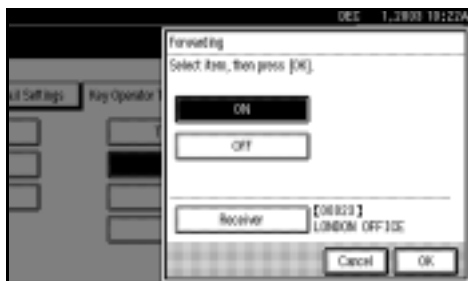
Quitting the forwarding function**1** Press the [User Tools/Counter] key.**2** Press [Facsimile Features].**3** Press [Key Operator Tools].**4** Press [Forwarding].**5** Press [OFF], and then press [OK].**6** Press the [User Tools/Counter] key.

The standby display appears.

Forwarding Mark

You can print a Forwarding Mark on the receiver's messages that have been forwarded.

The receiver can distinguish between forwarded messages and usual receptions.

Note

- You can specify whether or not to print a Forwarding Mark in the User Parameters. See p.159 "User Parameters" (switch 02, bit 0).

GfMten0e.eps

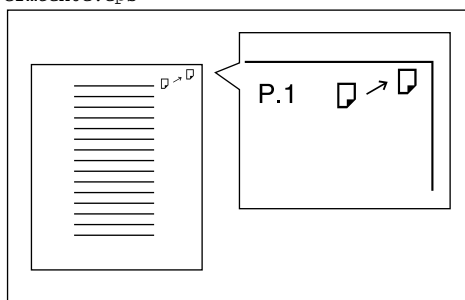

Memory Lock

When you switch Memory Lock on, received messages are stored in memory and not printed automatically. When a message is received in the Memory Lock mode, the Confidential File (🔒) indicator blinks. To print this message, enter the Memory Lock ID. A user without the ID cannot print the message. This prevents unauthorized users from seeing the message.

Preparation

To use Memory Lock, program the Memory Lock ID, and then switch Memory Lock on. See p.183 "Programming a Memory Lock ID".

Note

- To store incoming documents from Special Senders only in Memory Lock, program each sender with "Special Senders to Treat Differently". See p.163 "Special Senders to Treat Differently".

1 Press the [User Tools/Counter] key.

ZHPS180E.eps

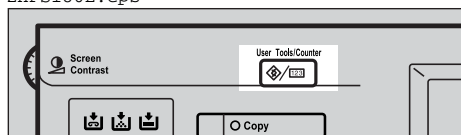

2 Press [Facsimile Features].

3 Press [Key Operator Tools].

4 Press [Memory Lock RX].

5 Select [ON] or [OFF], and then press [OK].



Note

- To cancel this setting, press [Cancel]. The display returns to that of step 4.

6 Press the [User Tools/Counter] key.

The standby display appears.

ECM

If part of a transmission fails because of a line problem, the lost data is automatically resent. For this function to work, the other machine must have ECM. You can turn this function on or off through the following procedure.

Note

- r If you turn ECM off, you cannot use the following functions:
- JBIG Transmission
 - Super G3 Communication

1 Press the **[User Tools/Counter]** key.

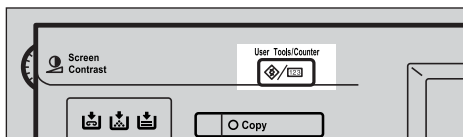

2 Press **[Facsimile Features]**.

3 Press **[Key Operator Tools]**.

4 Press **[ECM]**.

5 Select **[ON]** or **[OFF]**, and then press **[OK]**.



Note

- r To cancel this setting, press **[Cancel]**. The display returns to that of step **4**.

6 Press the **[User Tools/Counter]** key.

The standby display appears.

User Parameters

User Parameters allow you to customize various settings to suit your needs. To change function settings, set the User Parameter Switches.

Preparation

Access to some User Parameter Settings requires installation of optional equipment, or that other settings be made beforehand.

v Switches and Bits

Each User Parameter has a set of switches, and each of the switches consist of eight bits, whose values are "0" or "1". The right most bit is bit 0 and the left most is bit 7. You can adjust the settings to match your needs by switching the value of bits between "0" and "1".

Switch 02	0	0	1	1	1	0	1	1
	↓	↓	↓	↓	↓	↓	↓	↓
	7	6	5	4	3	2	1	0

v User Parameter List

User Parameter Switches are outlined below.

Switch	Bit	Item	0	1
02	0	Forwarding Mark	Off	On
	3	TSI Print	Off	On
03	0	Automatic printing of the Memory Transmission Result Report	Off	On
	2	Automatic printing of the Memory Storage Report	Off	On
	3	Automatic printing of the Polling Reception Reserve Report	Off	On
	4	Automatic printing of the Polling Reception Result Report	Off	On
	5	Automatic printing of the Immediate Transmission Result Report	Off	On
	6	Automatic printing of the Polling Transmission Clear Report	Off	On
	7	Automatic printing of the Journal	Off	On
04	0	Automatic printing of the Confidential File Report	Off	On
	7	Include a portion of the image on reports	Off	On

Switch	Bit	Item	0	1
05	0	Receive Service Call (SC) Condition (Substitute Reception during service call)	Possible (Substitute RX)	Not possible (Reception off)
	2, 1	Substitute the reception when the machine cannot print (because all paper trays have run out of paper, toner is empty, or all paper trays are out of order) 00: Enabled unconditionally (Free) 01: Enabled when Own Name/Own Fax Number is received 10: Enabled for Polling ID match 11: Disabled (Reception off)		
	5	Just Size Printing	Off	On
	7	Empty tray alert (Paper Empty Warning) even when one paper tray is empty	Off	On
06	6	First page scanned for book originals	From the left page	From the right page
07	2	Parallel Memory Transmission	Off	On
08	2	Authorized Reception Type	Receiving from only specified senders	Receiving all messages except those from specified senders
10	1	Combine two originals	Off	On
	3	Page reduction when printing	Off	On
11	6	Local print when forwarding	Off	On
	7	Polling file after sending (Polling transmission standby time)	Delete (Use Once)	Standby (Save)
14	0	Print documents received with Auto Power-On Reception (Night Printing mode)	Immediate printing (On)	When turning on the operation switch (Off)
	1	Long Document Transmission (Well Log)	Off	On
	2	Batch Transmission	Off	On
	3	Reset when function changed	Off	On
	7	System Parameter List Transmission	Off	On
17	2	Whether you need to press [Add] after entering a Quick Dial/Group Dial when broadcasting	Not necessary	Necessary
	7	Receive messages by pressing the [Start] key when originals are not set.	Off (The machine does not receive messages by pressing the [Start] key.)	On (The machine receives messages by pressing the [Start] key.)

Switch	Bit	Item	0	1
18	0	Print date with Fax Header	Off	On
	1	Print transmitter origin with Fax Header	Off	On
	2	Print file number with Fax Header	Off	On
	3	Print page number with Fax Header	Off	On
19	0	Use paper delivery shift function (Offset Print)	Off	On
	1	Sort Journal by line type	Off	On
20	0	Automatic printing of the LAN-Fax Error Report	Off	On
	1	Reprint documents that could not be printed using LAN-Fax Driver	Off	On
	5, 4, 3, 2	Reprinting time of stored documents in memory that could not be printed using LAN-Fax Driver 0000: 0 minute / 0001: 1 minute / 0010: 2 minutes / 0011: 3 minutes / 0100: 4 minutes / 0101: 5 minutes / 0110: 6 minutes / 0111: 7 minutes / 1000: 8 minutes / 1001: 9 minutes / 1010: 10 minutes / 1011: 11 minutes / 1100: 12 minutes / 1101: 13 minutes / 1110: 14 minutes / 1111: 15 minutes		
	7	Notify LAN-Fax Result by E-mail	Off	On
21	0	Print results of sending Reception Notice Request message	Off (print only when an error occurs)	On
	1	Respond to e-mail reception acknowledgment request	Off	On
	4	Transmit Journal by E-mail	Off	On
	6	Not display Network error	Display (Off)	Not display (On)
	7	Transmit Error Mail Notification	On	Off
24	1, 0	Store a message in memory that could not be transmitted 00: Off, 01: Store for 24 hours, 11: Store for 72 hours		
25	4	RDS	Off	On
32	0	Priority destination for Forwarding	Fax Destination	E-mail Address

Changing the User Parameters

Important

- r We recommend you print and keep a User Parameter list when you program or change a User Parameter. See p.162 "Printing the User Parameter List".
- r Do not change any bit switches other than those shown on the previous pages.

1 Press the [User Tools/Counter] key.

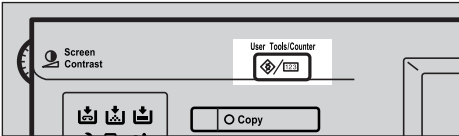

2 Press [Facsimile Features].

3 Press [Key Operator Tools].

4 Press [Parameter Setting].

5 Select the switch number you want to change.

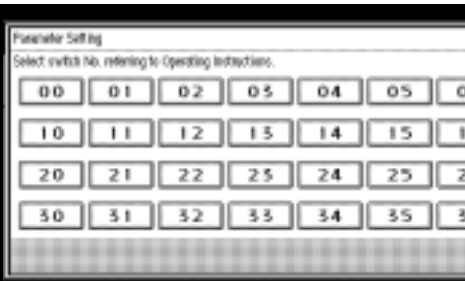

6 Select the bit number you want to change.

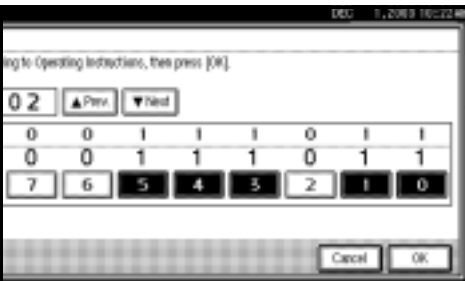

When the bit number is pressed, the current value switches between 1 and 0.

Note

- r Repeat from step **6** to change another bit number for the same switch.

7 Press [OK].

Note

- r To cancel these settings, press [Cancel]. The display returns to that of step **5**.

8 Repeat steps **5** and **6** to change the switch settings.

9 After all the settings are finished, press [Exit].

10 Press the [User Tools/Counter] key. The standby display appears.

Printing the User Parameter List

Print this list to see the current User Parameter settings. However, only items of importance or often-used items are included in the list.

1 Press the [User Tools/Counter] key.

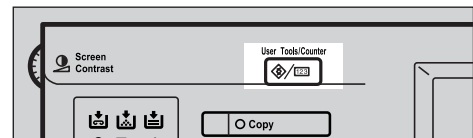

2 Press [Facsimile Features].

3 Press [Key Operator Tools].

4 Press [Print List] next to [Parameter Setting].

Note

- r To cancel printing a list, press [Cancel]. The display returns to that of step **4**.

5 Press the **[Start]** key. **Note**

- r To cancel printing a list after pressing the **[Start]** key, press **[Stop Printing]**. The display returns to that of step **4**.

6 Press the **[User Tools/Counter]** key.

The standby display appears.

Special Senders to Treat Differently

By programming particular receivers in advance, you can set the following function for each receiver:

- Authorized Reception
- Forwarding
- Reception File Print Quantity
- Print 2 Sided
- Memory Lock
- Reception Reverse Printing
- Paper Tray

Use the Own Name or Own Fax Number to program your receivers. If the receiver has a machine of the same manufacturer, program an Own Name that has already been programmed as a receiver. If the machine is not of the same manufacturer, use Own Fax Number. You can apply the same settings to all programmed numbers. You can then customize the settings for individual numbers as necessary using the Special Sender Registration function.

The following items can be programmed.

- Special Senders (Up to 30. A maximum of 50 when the optional fax function upgrade unit is installed. A maximum of 20 characters for each name when using G3.)
- Full/ Partial agreement
When you program own names and facsimile names for multiple destinations, you can program a common sequence of characters to identify destinations using Partial agreement.

v Using a Full agreement

Destination to be programmed (Own Name)	Number of programmed identifications
NEW YORK BRANCH	3
HONG KONG BRANCH	
SYDNEY BRANCH	

v Using a Partial agreement

Destination to be programmed (Own Name)	Number of programmed identifications
BRANCH	1

 **Note**

- r You can program up to 30 wild cards (50 with the optional fax function upgrade unit).
- r Spaces are ignored when identifications are compared.
- r You can use wild cards for the following functions:
 - See p.166 "Programming/ Changing Special Senders".
 - See p.167 "Authorized RX (Authorized Reception)".
 - See p.167 "Forwarding".

- r You cannot use the following functions with Internet Fax receptions.
 - Authorized Reception
 - Reception File Print Quantity
 - Memory Lock
 - Reception Reverse Printing
- r To use the Forwarding, Print 2 Sided, or Paper Tray with Internet Fax receptions, program the e-mail address of the sender.

Limitation

- r You cannot program senders as Special Senders if they do not have Own Name or Own Fax Number programmed.
- r The machine cannot differentiate between Polling Reception and Free Polling documents from Special Senders.

Note

- r You can program up to 24 characters for the sender.
- r You can check Own Name and Own Fax Number using the Journal. You can check programmed Special Senders using the specified sender list. See p.27 "Printing the Journal". See p.171 "Printing the Special Sender List".
- r If you select "OFF" for the Special Sender function in "Initial Set Up", the settings will be the same as the Reception Settings. See p.144 "Reception Settings".

Authorized Reception

Use this function to limit incoming senders. The machine only receives faxes from programmed Special Senders, and therefore, it helps you screen out unwanted messages, such as junk mail, and saves wasting fax paper.

Note

- r To use this function, program the Special Senders function, and then select "ON" in "Authorized RX" with "Reception Settings". See p.144 "Reception Settings". See p.159 "User Parameters" (switch 08, bit 2).
- r Without programming Special Senders, the Authorized RX function will not work, even if you select "ON".
- r You can select to receive only from programmed senders or receive only from senders other than those programmed in User Parameters. See p.159 "User Parameters" (switch 08, bit 2).
- r If you select "OFF" for "Authorized RX" in "Initial Set Up", the settings will be the same as the Reception Mode settings. See p.144 "Reception Settings".
- r You can change Special Senders in the same way as you program them.

Forwarding

Use this function to print received messages, and then transfer them to those receivers programmed beforehand.

It is also possible to forward faxes sent only by senders programmed as Special Senders.

Note

- r To use this function, program your Special Senders, and then select "ON" for "Forwarding" in "Reception Settings". See p.144 "Reception Settings".
- r If you specify "ON" in "Forwarding" and select [**Same as basic settings**], the fax message will be forwarded to the other ends programmed in "Specify End Receiver". See p.155 "Forwarding".
- r If you do not program any Special Senders, the machine transfers all incoming documents to the other end specified in "Specify End Receiver".
- r You can program e-mail address as the receiver.

Reception File Print Quantity

Use this function to print the specified number of copies of documents received from programmed senders (Special Senders). If you do not program any Special Senders, the machine prints the specified number of copies for all received documents.

Limitation

- r You cannot use multi-copy printing with Polling Reception, Free Polling, Confidential Reception, or Memory Lock.

Note

- r You can specify up to 10 copies.

Print 2 Sided

Use this function to print on both sides of paper.

Limitation

- r If you select the bypass tray for "Paper Tray", duplex printing is disabled.

Memory Lock

Use this function to store incoming documents from programmed senders (Special Senders) in memory without printing them. People without the Memory Lock ID cannot print the documents, and therefore this function is useful for receiving confidential documents. If you do not program any senders, the machine receives fax message from all senders using Memory Lock reception.

Reference

p.183 "Programming a Memory Lock ID"

Limitation

- r If you program the same sender in Memory Lock and Forwarding, Forwarding is disabled.

Reception Reverse Printing

Use this function to print the pages in reverse order. See p.100 "Reverse Order Printing".

Paper Tray

Use this function to print documents received from programmed senders (Special Senders) and the documents from other senders on different types of paper.

For example, if blue paper is in Tray 1 and white paper is in Tray 2, the machine prints the documents from Special Senders on the blue paper and prints the documents from other senders on the white paper, making it easy for you to separate the two.

If you do not program any Special Senders, the machine outputs documents received from all senders using the default paper tray.

Limitation

For Polling Reception and Free Polling, you cannot select the paper tray.

Note

If the machine receives a message that has a different size from the paper in the specified tray, the machine prints it after splitting it or minimizing its size. See p.100 "Page Separation and Length Reduction".

Selection of the bypass tray enables you to specify the paper size in "Scan Area".

Programming/ Changing Special Senders

1 Press the [User Tools/Counter] key.

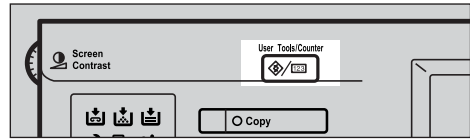

2 Press [Facsimile Features].

3 Press [Key Operator Tools].

4 Press [Program Special Sender].

5 Select the destination to program or change.



When programming a new Special Sender, press [*Not Programmed].

6 Enter a destination name, and then press [OK].

Enter a destination name using Own Name or Own Fax Number.

Reference

"Entering Text", *General Settings Guide*

7 Press [Full agreement] or [Partial agreement].



- 8** Select the item you want to program.



Note

- r You must select only the item you want to program.
- r To cancel these settings, press **[Cancel]**. The display returns to that of step **5**.

Authorized RX (Authorized Reception)

- A Select **[Authorized RX]**.
- B Press **[ON]** or **[OFF]**, and then press **[OK]**.

Note

- r After you perform step **9**, set "Authorized RX" of "Reception Settings" to "ON". See p.144 "Reception Settings".

Forwarding

- A Select **[Forwarding]**.
- B Select **[ON]** or **[OFF]**.



If you select **[OFF]**, proceed to step D.

Note

- r Selecting **[Same as basic settings]** will result in the same setting made for "Forwarding" under "Key Operator Tools". See p.155 "Forwarding".

C Specify an End Receiver.



D Press **[OK]**.

If you select **[ON]**, the name of the End Receiver appears to the right of "Receiver".

E Press **[OK]**.

Note

- r After you perform step **9**, set "Forwarding" of "Reception Settings" to "ON". See p.144 "Reception Settings".

Reception File Print Qty

- A Select **[Reception File Print Qty]**.
- B Press **[Number of Sets]**.



Note

- r Selecting **[Same as basic settings]** will result in the same setting made for “RX File Print Qty” of “Reception Settings”. See p.144 “Reception Settings”.
- C Enter the print quantity using the number keys, and then press **[OK]**.

**Note**

- r If you make a mistake, press **[Clear]** or the **[Clear/Stop]** key before pressing **[OK]**, and then try again.

Print 2 Sided

- A Select **[Print 2 Sided]**.
- B Select **[ON]** or **[OFF]**, and then press **[OK]**.

Note

- r Selecting **[Same as basic settings]** will result in the same setting made for “2 Sided Print” of “Reception Settings”. See p.144 “Reception Settings”.

Memory Lock

- A Select **[Memory Lock]**.
- B Select **[ON]** or **[OFF]**, and then press **[OK]**.

Note

- r Selecting **[Same as basic settings]** will result in the same setting made for “Program Memory Lock ID” under “Key Operator Tools”. See p.157 “Memory Lock”.

RX Reverse Printing (Reception Reverse Printing)

- A Select **[RX Reverse Printing]**.
- B Select **[ON]** or **[OFF]**, and then press **[OK]**.

Note

- r Selecting **[Same as basic settings]** will result in the same setting made for “RX Reverse Printing” of “Reception Settings”. See p.144 “Reception Settings”.

Paper Tray

- A Select **[Paper Tray]**.
- B Select the tray you want to use, and then press **[OK]**.

Note

- r Selecting **[Same as basic settings]** will result in the same setting made for “Paper Tray” of “Reception Settings”. See p.144 “Reception Settings”.

9 Press [OK].

A Special Sender has been programmed.

Note

To program another sender, repeat the procedure from step **5**.

10 Press [Exit].**11** Press the [User Tools/Counter] key.

The standby display appears.

Programming Initial Set Up of a Special Sender

Use this function to program “Initial Set Up” of a Special Sender. You can also specify the Bypass Tray Paper Size.

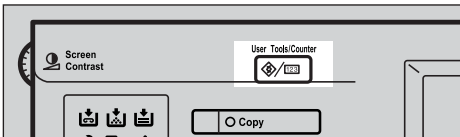
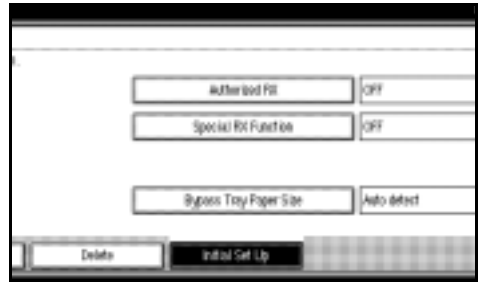
1 Press the [User Tools/Counter] key.**2** Press [Facsimile Features].**3** Press [Key Operator Tools].**4** Press [Program Special Sender].**5** Press [Initial Set Up].**6** Select the function you want to program.**Note**

In this feature, “Authorized RX” has the same settings as “Reception Settings”. See p.144 “Reception Settings”.

Programming Authorized RX and Special RX Function

A Select [Authorized RX] or [Special RX Function].

B Select [ON] or [OFF], and then press [OK].

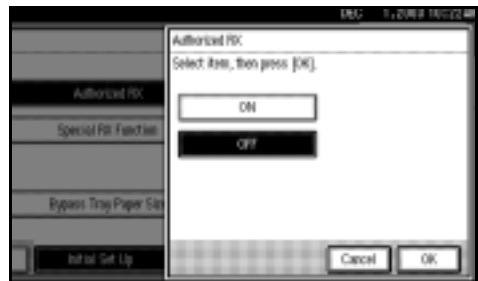

The illustration shows the “Authorized RX” display as an example.

Programming Bypass Tray Paper Size

A Press [Bypass Tray Paper Size].

You can select a size from [Auto Detect], [Standard Size], or [Custom Size].

If you select [Auto Detect], proceed to steps B and G.

If you select [Standard Size], proceed to steps B, C, and G.

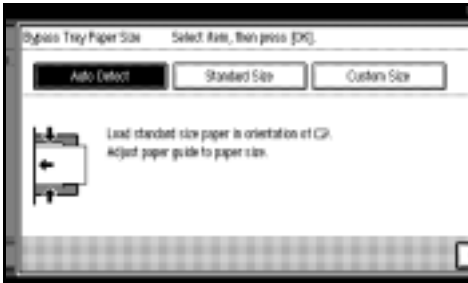

If you select [Custom Size], proceed to steps B, and D to G.

B Select the size you want to program.



Note

r If you select [Auto Detect], the machine recognizes the paper size automatically.

- The machine will detect the paper size for the bypass tray as the short edge of the paper is inserted into the machine. Even if you placed an A4 size sheet in the  orientation, the machine will detect it as A3 .

r If you select [Standard Size], select a paper size displayed, and then proceed to step G.

r If you select [Custom Size], proceed to step D.

C Select the size you want to program from the sizes shown.

D Make sure that [Vertical] is selected.

Note

r If [Vertical] has not been selected, press [Vertical].

E Enter the vertical size of the paper using the number keys, and then press [#].

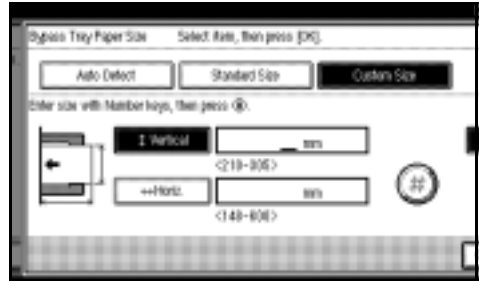

Note

r You can specify a vertical size from 210 mm (8.3 inch) to 305 mm (12.0 inch). You cannot enter a size smaller than 210 mm or larger than 305 mm.

r Each time you press [mm] or [inch], the units switch between "mm" and "inch". If you enter a length and change the units by pressing [mm] or [inch], it is converted automatically (fractions are rounded off).

F Enter the horizontal size of the paper using the number keys, and then press [#].

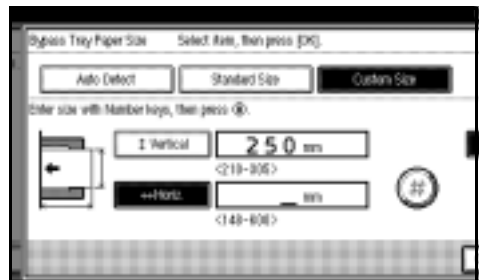

Note

- r You can specify a horizontal size from 148 mm (5.9 inch) to 600 mm (23.7 inch). You cannot enter a size smaller than 148 mm or larger than 600 mm.
- r Each time you press **[mm]** or **[inch]**, the units switch between “mm” and “inch”. If you enter a length and change the units by pressing **[mm]** or **[inch]**, it is converted automatically (fractions are rounded off).

G Press **[OK]**.

7 Press **[Exit]**.

8 Press the **[User Tools/Counter]** key.

The standby display appears.

Deleting a Special Sender

Use this function to program “Initial Set Up” of a Special Sender. The Bypass Tray Paper Size can also be specified.

1 Press the **[User Tools/Counter]** key.

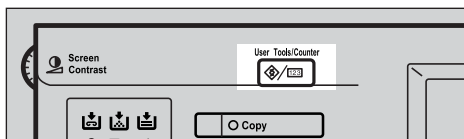

2 Press **[Facsimile Features]**.

3 Press **[Key Operator Tools]**.

4 Press **[Program Special Sender]**.

5 Press **[Delete]**, and then select the Special Sender you want to delete.

6 Press **[Delete]**.

Note

- r To cancel deleting a special sender, press **[Do not Delete]**. The display returns to that of step **5**.

7 Press **[Exit]**.

8 Press the **[User Tools/Counter]** key.

The standby display appears.

Printing the Special Sender List

1 Press the **[User Tools/Counter]** key.

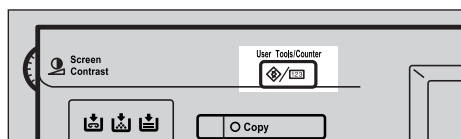

2 Press **[Facsimile Features]**.

3 Press **[Key Operator Tools]**.

4 Press **[Print List]** next to “Program Special Sender”.

Note

- r To cancel printing, press **[Cancel]**. The display returns to that of step **4**.

5 Press the **[Start]** key.

Note

- r To cancel printing after pressing the **[Start]** key, press **[Stop Printing]**. The display returns to that of step **4**.

6 Press the **[User Tools/Counter]** key.

The standby display appears.

Box Settings

The following functions are for delivery and transfer of messages:

- Personal Box
- Information Box
- Transfer Box

Reference

For details about how to set up these functions:

- p.172 “Programming/changing Personal Boxes”
- p.175 “Programming/changing Information Boxes”
- p.178 “Programming/changing Transfer Boxes”

For details about how to print out and delete messages stored in boxes:

- p.40 “Personal Boxes”
- p.42 “Information Boxes”

Limitation

- r You cannot set the same Box code on two different boxes.
- r Transmission or programming may not be allowed if there is not enough free memory left. The amount of free memory left differs depending on the optional equipment installed.

Note

- r The combined total of items that can be stored using the Personal Box, Information Box, and Transfer Box functions is 150. Installing the optional fax function upgrade unit increases this capacity to 400.

Programming/changing Personal Boxes

This section describes how to program Personal Boxes.

You can store the following items:

- Box name (required)
Up to 20 characters long
- SUB Code (required)
Up to 20 characters long and can be composed of digits 0-9, “#”, “*”, and spaces (the first character cannot be a space).
- Password (optional)
Up to 20 characters long and can be composed of digits 0-9, “#”, “*”, and spaces (the first character cannot be a space).

Note

- r When programming a password, a mark is displayed before the Box name.
- Receiver (optional)
You can program one delivery destination for each Personal Box. Specify a delivery destination programmed in Quick Dial.

Note

- r An e-mail address can be set as the transmission destination.
- r The contents of the Personal Box will be saved until printing is completed.
- r The Fax Header is not printed on delivered messages.
- r If a message cannot be delivered, a Communication Failure Report is printed and the message is saved as a Confidential Reception document.
- r You can edit boxes in the same way you program them. However, to change the SUB Code itself, you must delete the box, and then program a new SUB Code.

- r If the fax number or e-mail address of a programmed receiver is deleted using System Settings, the setting for the receiver is cancelled and a message is not delivered. If the fax number or e-mail address of a programmed receiver is changed, a message is delivered to the new fax number.

Reference

p.40 "Personal Boxes"

- 1** Press the **[User Tools/Counter]** key.

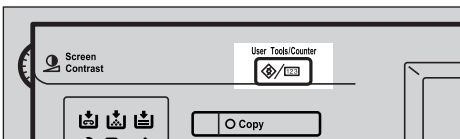

- 2** Press **[Facsimile Features]**.

- 3** Press **[Key Operator Tools]**.

- 4** Press **[Box Setting]**.

- 5** Select a box to program.

When programming a new box, press **[*Not Programed]**.

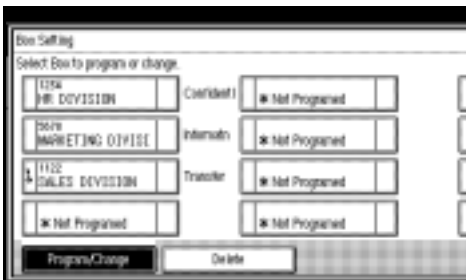

Note

- r To change a box already programmed, press it and proceed to step **3**.

- 6** Press **[Personal Box]**.

- 7** Enter a box name, and then press **[OK]**.

Reference

"Entering Text", *General Settings Guide*

- 8** Enter a SUB Code.

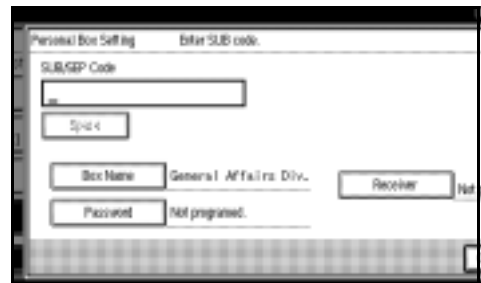

Note

- r To change the SUB Code, press **[Clear]** or the **[Clear/Stop]** key, and then try again. To change a Box name, press **[Box Name]**, and then repeat the procedure from step **7**.

- 9** Specify the settings you require.

If you do not want to program a password or receiver, proceed to step **10**.

Programming a password

- A** Press **[Password]**.

- B** Enter a password, and then press **[OK]**.



Note

- r If you make a mistake, press **[Clear]** or the **[Clear/Stop]** key before pressing **[OK]**, and then try again.

- C Re-enter the password, and then press [OK].

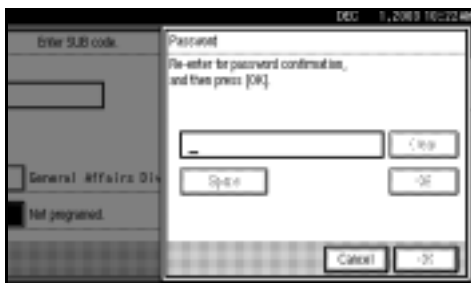

Note

- r If you make a mistake, press [Clear] or the [Clear/Stop] key before pressing [OK], and then try again.
- r If you want to change the password after pressing [OK], press [Change], and then perform from step B.

- D Press [OK].

Programming an End Receiver

- A Press [Receiver].

- B Select a destination using the Quick Dial Table, and then press [OK].

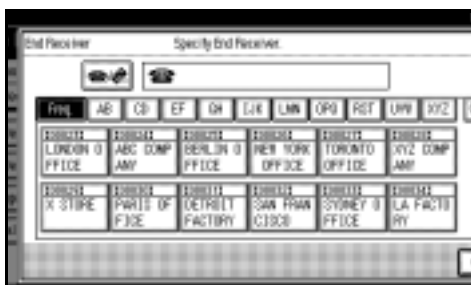

- 10 Press [OK] twice.
- 11 Press [Exit].
- 12 Press the [User Tools/Counter] key.

The standby display appears.

Deleting Personal Boxes

This section describes how to delete Personal Boxes.

Limitation

- r If messages have been programmed in the box, you cannot delete the box.

- 1 Press the [User Tools/Counter] key.

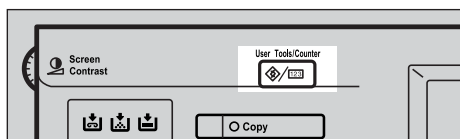

- 2 Press [Facsimile Features].

- 3 Press [Key Operator Tools].

- 4 Press [Box Setting].

- 5 Press [Delete], and then select the box you want to delete.

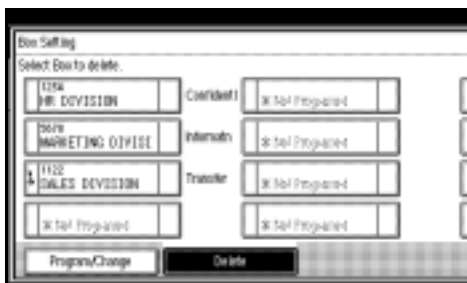

With a programmed password

- A Enter a password using the number keys, and then press [OK].



Note

- r If you make a mistake, press [Clear] or the [Clear/Stop] key.

- 6** Press [Delete].

Note

- r To cancel deleting a box, press [Do not Delete]. The display returns to that of step 5.

- 7** Press [Exit].

- 8** Press the [User Tools/Counter] key.
The standby display appears.

Programming/changing Information Boxes

This section describes how to set up an Information Box.

You can store the following items:

- Box name (required)
Up to 20 characters long
- SEP Code (required)
Up to 20 characters long and can be composed of digits 0-9, "#", "*", and spaces (the first character cannot be a space).

- Password (optional)
Up to 20 characters long and can be composed of digits 0-9, "#", "*", and spaces (the first character cannot be a space).

Note

- r When programming a password, a mark is displayed before the Box name.

Note

- r You can edit boxes in the same way you program them. However, to change the SEP Code itself, you must delete the box, and then program a new SEP Code.

Reference

p.42 "Information Boxes"

- 1** Press the [User Tools/Counter] key.

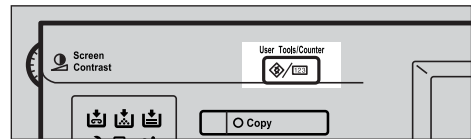

- 2** Press [Facsimile Features].

- 3** Press [Key Operator Tools].

- 4** Press [Box Setting].

- 5** Select the box to program.

When programming a new box, press [*Not Programed].

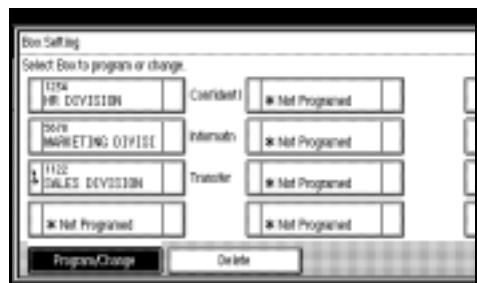

Note

r To change a box already programmed, press it, and then proceed to step 6. If a password has been programmed, enter the password, press [OK], and then proceed to step 8.

6 Press [Information Box].

7 Enter a box name, and then press [OK].

Reference

“Entering Text”, *General Settings Guide*

8 Enter the SEP Code.

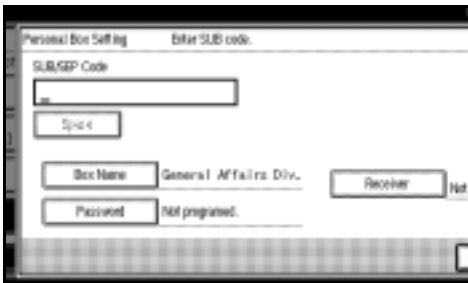

Note

r To change the SEP Code, press [Clear] or the [Clear/Stop] key, and then try again. To change the box name, press [Box Name], and then repeat the procedure from step 7.

9 Press [Password].

Note

r If you do not want to program a password, proceed to step 10.

10 Enter a password, and then press [OK].



Note

r If you make a mistake, press [Clear] or the [Clear/Stop] key before pressing [OK], and then try again.

11 Re-enter the password, and then press [OK].

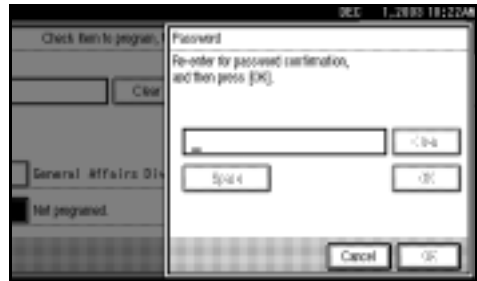

Note

r If you make a mistake, press [Clear] or the [Clear/Stop] key before pressing [OK], and then try again.

r If you want to change the password after pressing [OK], press [Change], and then perform from step 10.

12 Press [OK].

13 Press [OK].

14 Press [Exit].

15 Press the [User Tools/Counter] key.

The standby display appears.

Deleting Information Boxes

This section describes how to delete Information Boxes.

! Limitation

r If messages have been programmed in the box, you cannot delete the box.

1 Press the **[User Tools/Counter]** key.

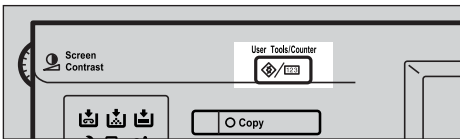

2 Press **[Facsimile Features]**.

3 Press **[Key Operator Tools]**.

4 Press **[Box Setting]**.

5 Press **[Delete]**, and then select the box you want to delete.

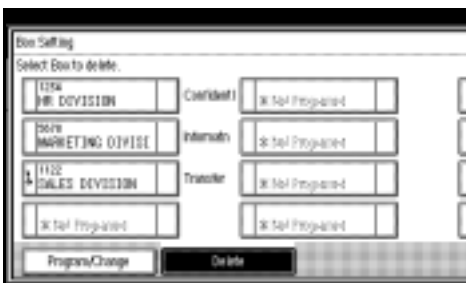

With a programmed password

A Enter a password using the number keys, and then press **[OK]**.



Note

r If you make a mistake, press **[Clear]** or the **[Clear/Stop]** key.

6 Press **[Delete]**.

Note

r To cancel deleting a box, press **[Do not Delete]**. The display returns to that of step **5**.

7 Press **[Exit]**.

8 Press the **[User Tools/Counter]** key.
The standby display appears.

Programming/changing Transfer Boxes

This function turns your machine into a fax relay station. Documents sent with a SUB Code that matches the SUB Code programmed as a Transfer Box are received, and then relayed to a programmed receiver.

Since documents can be sent to multiple destinations in a single transfer request, you can economize on call charges when sending to remote destinations.

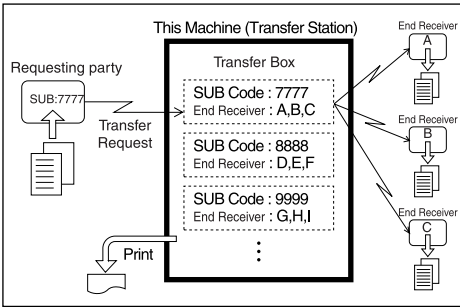

Note

Inform the Requesting Party of the SUB Code assigned to the Transfer Box. When they want to have a message transferred by your machine, ask them to send the message using SUB Code Transmission and specifying this SUB Code. If a password has also been programmed, inform them of this too, and ask them to enter it as the SID code.

You can store the following items:

- Box name (required)
Up to 20 characters
- SUB (required)
Up to 20 characters long and can be composed of digits 0-9, "#", "*", and spaces (the first character cannot be a space).

- Password (optional)
Up to 20 characters long and can be composed of digits 0-9, "#", "*", and spaces (the first character cannot be a space).

Note

When programming a password, a mark is displayed in front of the Box name.

- End Receiver (required)
You can store five End Receivers (destinations to which messages will be forwarded) for each box. Specify End Receivers with Quick Dials or Groups assigned to Quick Dials that have been programmed beforehand.

Limitation

After messages are transferred, Transfer Result Reports are not sent back to the sender.

Note

- An e-mail address can be set as the End Receiver.
- After messages are transferred, they are deleted.
- When this function is turned on, the machine prints out the received messages it transfers and a Transfer Result Report after the transfer has finished. If you want to turn this function off, please contact your service representative.
- When the programmed receiver is a Multi-step Transfer Group Dial, Multi-step Transfer takes place. For more information, contact your service representative.
- You can edit boxes in the same way you program them.

- r Deleting a destination specified as an end receiver from the Address Book causes the settings for the end receiver to be deleted. If this is the case, reprogram the end receiver. If the destination has been changed, a message is transmitted to the new destination.

1 Press the **[User Tools/Counter]** key.

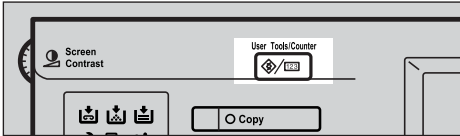

2 Press **[Facsimile Features]**.

3 Press **[Key Operator Tools]**.

4 Press **[Box Setting]**.

5 Select a box to program.

When programming a new box, press **[*Not Programed]**.

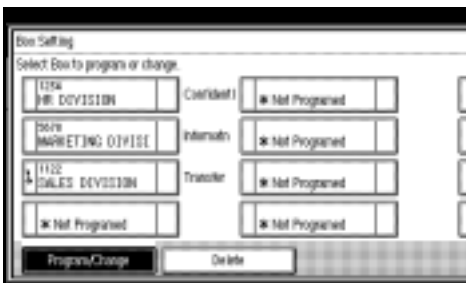

Note

- r To change a box already programmed, press it, and then proceed to step .

6 Press **[Transfer Box]**.

7 Enter a Box name, and then press **[OK]**.

Reference

“Entering Text”, *General Settings Guide*

8 Enter a SUB Code.

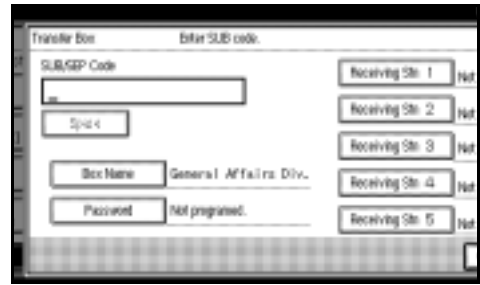

Note

- r To change the SUB Code, press **[Clear]** or the **[Clear/Stop]** key, and then try again. To change Box name, press **[Box Name]**, and then repeat from step .

9 Specify the condition of registration.

Programming End Receivers

A Select an End Receiver.

Note

- r You can store five End Receivers.

B Specify End Receivers with Quick Dials, and then press **[OK]**.



Note

- r You can also specify End Receivers with Group Dials.

Note

- r Repeat from step A to specify another End Receiver.

Programming a password

If you do not want to program a password, proceed to step 10.

A Press **[Password]**.

B Enter a password, and then press **[OK]**.



Note

r If you make a mistake, press **[Clear]** or the **[Clear/Stop]** key before pressing **[OK]**, and then try again.

C Re-enter the password, and then press **[OK]**.

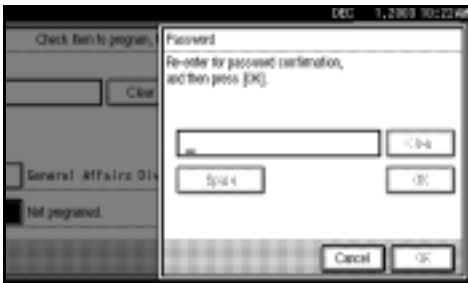

Note

r If you make a mistake, press **[Clear]** or the **[Clear/Stop]** key before pressing **[OK]**, and then try again.

r If you want to change the password after pressing **[OK]**, press **[Change]**, and then perform from step B.

D Press **[OK]**.

10 Press **[OK]**.

11 Press **[Exit]**.

12 Press the **[User Tools/Counter]** key.
The standby display appears.

Deleting Transfer Boxes

1 Press the **[User Tools/Counter]** key.

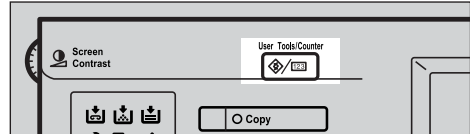

2 Press **[Facsimile Features]**.

3 Press **[Key Operator Tools]**.

4 Press **[Box Setting]**.

5 Press **[Delete]**, and then select the box you want to delete.



With a programmed password

A Enter a password using the number keys, and then press **[OK]**.



Note

- r If you make a mistake, press **[Clear]** or the **[Clear/Stop]** key.

6 Press **[Delete]**.**Note**

- r To cancel deleting a special sender, press **[Do not Delete]**. The display returns to that of step **6**.

7 Press **[Exit]**.**8** Press the **[User Tools/Counter]** key.

The standby display appears.

Printing the Box List

Follow the procedure below to print a list showing the currently programmed Personal Boxes, Information Boxes, and Transfer Boxes.

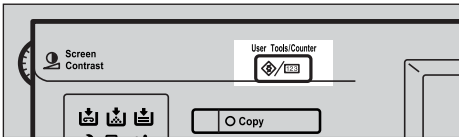
1 Press the **[User Tools/Counter]** key.**2** Press **[Facsimile Features]**.**3** Press **[Key Operator Tools]**.**4** Press **[Print List]** next to "Box Setting".**5** Press the **[Start]** key.

After printing the list, you can then start from step **4**.

Note

- r To cancel printing a list before pressing the **[Start]** key, press **[Cancel]** or the **[Clear/Stop]** key. The display returns to that of step **4**.

- r To cancel printing a list after pressing the **[Start]** key, press **[Stop Printing]**. The display returns to that of step **4**.

6 Press the **[User Tools/Counter]** key.

The standby display appears.

Transfer Report

For the Requesting Party to be able to receive Transfer Result Reports from the Transfer Station, the Requesting Party must program the number of the telephone line in connection on their own machine. See p.52 "Transfer Request".

Be sure to insert a pause after the area code.

For example, if you are in the United States and your fax number is 212-1234567, program the following:

- 1212-1234567

You can program the fax number for the G3 line.

Limitation

- r You cannot program or edit a Transfer Report when using a line (during communication). Program or edit after communication.

Note

- r You cannot use Transfer Request if the telephone number of their machine is not programmed into that machine.
- r Up to 16 digits are available for G3.

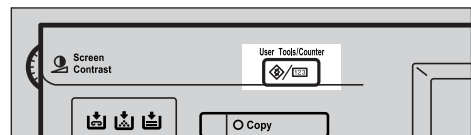
1 Press the **[User Tools/Counter]** key.

- 2** Press [**Facsimile Features**].
- 3** Press [**Key Operator Tools**].
- 4** Press [**Transfer Report**].
- 5** Specify the fax number.



Programming a G3 Fax Number

- A** Press [**G3 Fax No.(Dir.)**].
- B** Enter your facsimile number using the number keys, and then press [**OK**].



- Note**
- r If you make a mistake, press [**Clear**] or the [**Clear/Stop**] key.

- 6** Press [**Exit**].
- 7** Press the [**User Tools/Counter**] key.
The standby display appears.

Programming a Confidential ID

Program a Confidential ID to print a Confidential Reception. See p.36 "Printing a Confidential Message".

- Note**
- r If you do not program a Confidential ID, you cannot receive a Confidential Transmission.

- 1** Press the [**User Tools/Counter**] key.

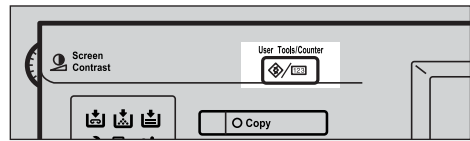

- 2** Press [**Facsimile Features**].
- 3** Press [**Key Operator Tools**].
- 4** Press [**Program Confidential ID**].
- 5** Enter an ID using the number keys, and then press [**OK**].



- Note**
- r A Confidential ID can be any four-digit number, except 0000.
- r If you make a mistake, press [**Clear**] or the [**Clear/Stop**] key before pressing [**OK**], and then try again.

To cancel programming an ID, press [**Cancel**]. The display returns to that of step **4**.

- 6** Press the [**User Tools/Counter**] key.
The standby display appears.

Programming a Polling ID

Program a Polling ID to use the Transfer Request, Transfer Station, Default ID Polling Transmission, and Default ID Polling Reception functions. When you use ID Transmission, program the same ID as the one programmed on the sender's machine.

Reference

p.10 "Polling Transmission"

p.13 "Polling Reception"

p.52 "Transfer Request"

p.75 "Selecting transmission options for a single transmission"

1 Press the [User Tools/Counter] key.

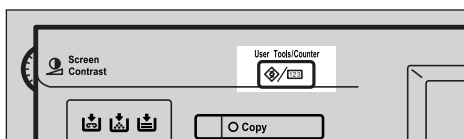

2 Press [Facsimile Features].

3 Press [Key Operator Tools].

4 Press [Program Polling ID].

5 Enter an ID using the number keys and [A] to [F], and then press [OK].

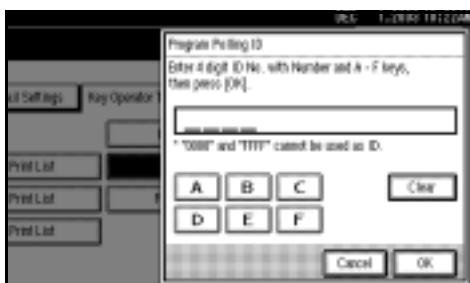

Note

r A Polling ID can be any combination of digits (0-9) and letters (A-F), except 0000 and FFFF.

r If you make a mistake, press [Clear] or the [Clear/Stop] key before pressing [OK], and then try again.

To cancel programming an ID, press [Cancel]. The display returns to that of step 4.

6 Press the [User Tools/Counter] key.

The standby display appears.

Programming a Memory Lock ID

Program a Memory Lock ID to be entered before printing documents when the Memory Lock function is activated.

Note

r A Memory Lock ID can be any four-digit number, except 0000.

1 Press the [User Tools/Counter] key.

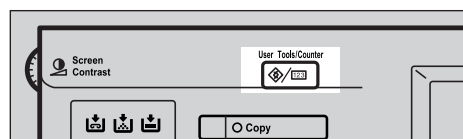

2 Press [Facsimile Features].

3 Press [Key Operator Tools].

4 Press [Program Memory Lock ID].

5 Enter an ID using the number keys, and then press [OK].



Note

If you make a mistake, press **[Clear]** or the **[Clear/Stop]** key before pressing **[OK]**, and then try again.

To cancel programming an ID, press **[Cancel]**. The display returns to that of step 4.

6 Press the **[User Tools/Counter]** key.

The standby display appears.

Selecting Dial/Push Phone

Use this function to select a line type when the machine is connected to a G3 analog line.

Dial and Push lines are available for selection.

Note

When the optional G3 expansion unit is installed, "G3-2" and "G3-3" appear.

This function is not available in some areas.

1 Press the **[User Tools/Counter]** key.

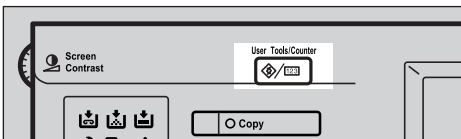

2 Press **[Facsimile Features]**.

3 Press **[Key Operator Tools]**.

4 Press **[Select Dial/Push Phone]**.

5 Press **[Push Button Phone]** or **[Dial Phone (10PPS)]** to select the line, and then press **[OK]**.



Reference

p.193 "Selecting the Line Type"

6 Press the **[User Tools/Counter]** key.

The standby display appears.

Storing or Printing Received Documents

The optional printer/scanner unit is required.

Specify whether received documents are to be saved on the hard disk or printed immediately without being saved. You can print stored documents repeatedly or download them as images to a computer using a Web browser or DeskTopBinder V2 Lite. If you select printing without saving, documents are printed each time they are received.

Limitation

If using System Settings you have set the machine to distribute received faxes to the delivery server, the documents cannot be saved on the hard disk.

 **Note**

- r If the facsimile is set to store received documents, document reception can be notified to a specified e-mail address.
- r Documents saved on the hard disk are categorized as received and stored documents. For details about printing saved documents, see p.34 “Printing/Deleting Received and Stored Documents (Print Stored RX File)”.
- r You cannot switch the setting if received documents have been stored on the hard disk. To switch the setting, print documents stored on the hard disk if necessary, and delete them.
- r Received confidential messages are stored in memory. Use the Print Confidential RX File function to print them.
- r With **[Store]** selected, more memory space will be used as the number of saved documents increase. After memory space becomes insufficient, no more documents are saved on the hard disk. If this happens, the machine will start printing and deleting saved documents with the oldest one.
- r You can store received documents up to a total of approximately 320 pages or 2,240 (when the optional expansion memory is installed) of A4 size Standard <ITU-T#4Chart>.
- r You cannot send received documents.
- r You cannot manage documents stored on the Document Server display.

1 Press the **[User Tools/Counter]** key.

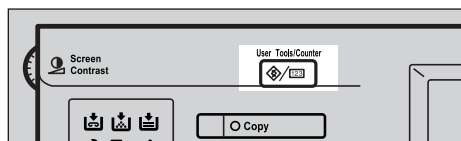

2 Press **[Facsimile Features]**.

3 Press **[Key Operator Tools]**.

4 Press **[Reception File Setting]**.

5 Select **[Print]** or **[Store]**, and then press **[OK]**.



 **Note**

- r To cancel your selection, press **[Cancel]**. The display returns to that of step **4**.
- r When "Store" is selected, you can select whether or not to notify a specific e-mail address of reception. If you want to notify the reception, press **[Notify Dest.]** and select an e-mail address from the Internet Fax destinations programmed in the address book.

6 Press the **[User Tools/Counter]** key.

The standby display appears.

Reception Report e-mail

When a received document is stored, this report is sent to the e-mail address set as the destination for notification.

Setting a User Code for Viewing Received and Stored Documents

You can view and print documents received and saved on the hard disk using a Web browser or DeskTop-Binder V2 Lite. Specify whether or not a user code is entered to view saved documents. If you want to use a user code, set one using a maximum of eight digits.

Note

- r This function is only available when received documents are saved on the hard disk. See p.184 "Storing or Printing Received Documents".
- r You can set a user code with the System Settings. See the *General Settings Guide*.
- r If the programmed user code has been deleted using the Address Book Management function under System Settings, you cannot view received and saved documents using a Web browser. Select **[OFF]** in step 5 or reprogram a user code.

1 Press the **[User Tools/Counter]** key.

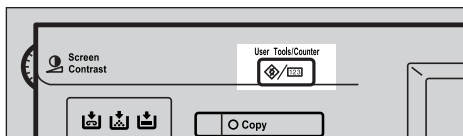

2 Press **[Facsimile Features]**.

3 Press **[Key Operator Tools]**.

4 Press **[Stored RX File User Code Setting]**.

5 If you want to use a user code, press **[ON]**.



Note

- r If you do not want to use a user code, press **[OFF]** and proceed to step 7.
- r To cancel the selection, press **[Cancel]**. The display returns to that of step 4.

6 Enter a user code (eight digits maximum) using the number keys, and then press **[#]**.

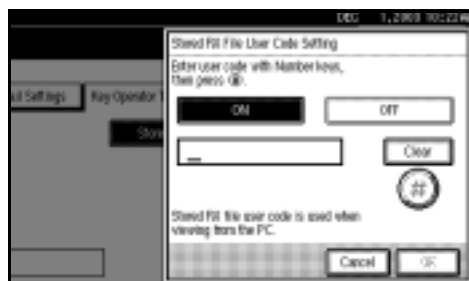

Note

- r If you enter a wrong user code, press **[Clear]** or the **[Clear/Stop]** key, and then try again.

7 Press **[OK]**.

8 Press the **[User Tools/Counter]** key. The standby display appears.

10. Solving Operation Problems

Reading Reports

Error Report

An Error Report is printed if a message cannot be successfully sent or received.

Possible causes include a problem with your machine or noise on the telephone line. If an error occurs during transmission, resend the original. If an error occurs during reception, ask the sender to resend the message.

Note

- r If an error happens frequently, contact your service representative.
- r The “Page” column gives the total number of pages. The “Page Not Sent” column gives the number of pages not sent or received successfully.

Power Failure Report

CAUTION:

- *When you disconnect the power plug from the wall outlet, always pull the plug (not the cable).*

Even if the main power switch is turned off, the contents of the machine memory (for example, programmed numbers) will not be lost. However, if power is lost for about one hour because the main power switch is turned off, there is a power cut, or the power cable is removed, contents of the Fax memory will be lost. Lost items will include any fax messages stored in memory using Memory Transmission/Reception, Auto Document, Confidential Reception, Memory Lock, or Substitute Reception.

If a file has been deleted from memory, a Power Failure Report is automatically printed as soon as the power is restored. This report can be used to identify lost files. If a memory stored for Memory Transmission was lost, resend it. If a message received by Memory Reception or Substitute Reception was lost, ask the sender to resend it.

 **Important**

- r Do not turn off the main power switch while the power indicator is lit or blinking. If you do, the hard disk and memory may be damaged and failure could result.
- r Turn off the main power switch before pulling out the plug. If you pull out the plug with the switch on, the hard disk and memory may be damaged and failure could result.
- r Make sure that 100% is shown on the display before you unplug the machine. If a lower value is shown, some data is currently present in memory.
- r Right after a power failure, the internal battery needs to be sufficiently recharged to guard against future data loss. Keep the machine plugged in and the main power switch on for about one week after the power loss.



 **RDS (Remote Diagnostic System)**

If your machine has a problem, a service representative can perform various settings over the telephone line from the service station.

If you want to use this function, change the User Parameter. See p.159 "User Parameters" (switch 25, bit 4).



When an Error Occurs Using Internet Fax

Error Mail Notification

The machine sends the Error Mail Notification to the sender when it is unable to successfully receive a particular e-mail message. A "cc" of this notification is also sent to the administrator's e-mail address when one is specified.

Note

- r You can select to send Error Mail Notification with User Parameters. See p.159 "User Parameters" (switch 21, bit 7).
- r If Error Mail Notification cannot be sent, the Error Report (Mail) is printed by the machine.
- r If an error occurs when an e-mail is received via SMTP, the SMTP server sends an error e-mail to the originator of the message.

Reference

- p.189 "Error Report (Mail)"
- p.159 "User Parameters"

Error Report (Mail)

The Error Report (Mail) is printed by the machine when it is unable to send an Error Mail Notification.

Server-Generated Error E-mail

The transmitting server sends this error e-mail to the originator of e-mail that cannot be transmitted successfully (due to reasons such as specifying an incorrect e-mail address).

Note

- r After a server-generated error e-mail is printed, the first page of the sent document is printed.

10

Replacing the Stamp Cartridge

The optional ADF is required.

When the stamp becomes lighter, replace the cartridge.

Note

- r Use the cartridge specified for this machine.
- r Do not add ink to the cartridge by yourself. Neglecting this can cause ink leakage.
- r Be sure not to dirty your fingers with ink from the cartridge.

1 Lift the ADF, and then open the stamp cover.

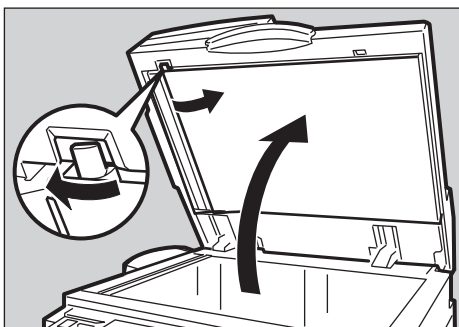

2 Pull out the cartridge.

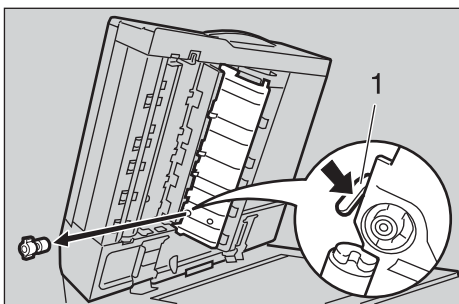

1. Cartridge Lock Lever

3 Set a new cartridge.

Insert the cartridge until the metal parts are no longer visible.

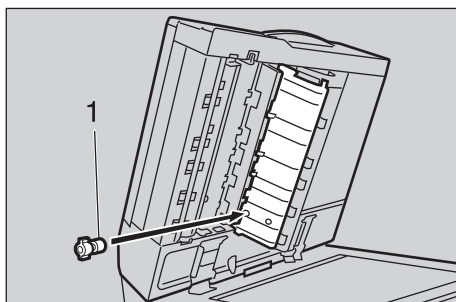

1. New cartridge

4 Replace the stamp cover until it clicks.

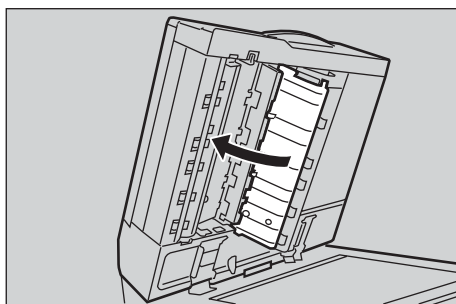

5 Lower the ADF.

Connecting the Machine to a Telephone Line and Telephone

Connecting the Telephone Line

To connect the machine to a telephone line, use a snap-in modular type connector.

⚠ CAUTION:

- To reduce the risk of fire, use only No. 26 AWG or larger telecommunication line cord.

⚠ ATTENTION:

- Pour réduire le risque d'incendie, utiliser uniquement des conducteurs de télécommunications 26 AWG ou de section supérieure.

⚡ Important

- r By law in the United States, you must program your phone number identification (your fax number) into your machine before you can connect the public phone system. See p.67 "Initial Settings and Adjustments", *Facsimile Reference* <Basic Features>.
- r Make sure the connector is the correct type before you start.
- v **Where to connect the machine**

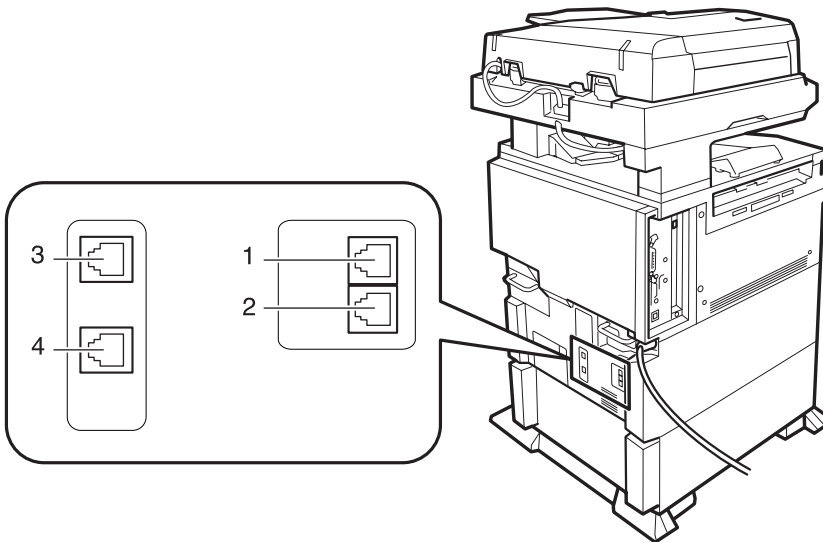

1. G3 interface unit connector
2. External telephone connector

3. Extra G3 interface unit connector
4. Extra G3 interface unit connector

🔧 Note

- r A maximum of two optional G3 lines can be connected.

Selecting the Line Type

Select the line type to which the machine is connected. There are two types: tone and pulse dial.

Note

r This function is not available in some areas.

Select the line type using “Key Operator Settings”. See p.184 “Selecting Dial/ Push Phone”.

Connecting the Optional Handset or an External Telephone

You can connect the optional handset or an external telephone to the machine. You can use it for telephone calls.

Note

r Some external telephones may not be connected or may suffer reduced functionality.

Limitation

r When you use the optional handset or an external telephone with the **[On Hook Dial]** key for telephone calls, you can not talk with the other party without pressing the **[On Hook Dial]** key after taking off the receiver.

v Specifying the handset line type

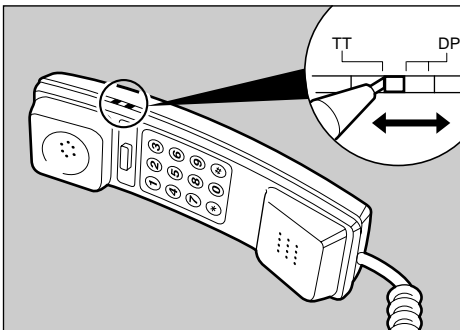

The switch on the handset should be in the appropriate position-TT (Tone Dialing) or DP (Pulse Dialing).

✓ **Adjusting the handset bell volume**

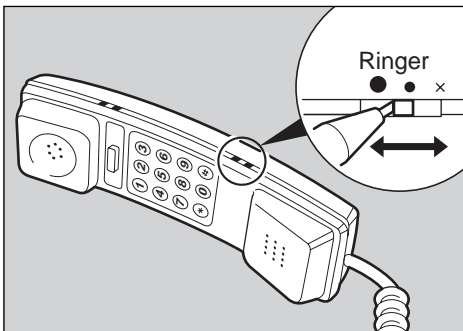

Adjust the handset ringer volume using the volume switch.

Optional Equipment

Fax Function Upgrade Unit

JBIG compression for transmission/reception becomes possible.

You can increase the maximum programmable numbers of the following functions. See p.201 “Maximum Values”.

- Quick Dial
- Memory Transmission file
- Auto Document
- Specific Sender
- Program
- Transmission Result
- Box

Expansion Memory (32MB: DIMM)

This allows you to send fax messages at high resolution (Super Fine). This also allows you to receive fax messages at high resolution (Fine or Super Fine). See p.201 “Maximum Values”.

Handset

You can make or receive calls by installing the optional handset and dialing manually.

 **Reference**

p.58 “Manual Dial”

Extra G3 Interface Unit

This option provides one extra G3 line connection.

A maximum of two G3 interface units can be installed.

Specifications

v Fax Transmission and Reception

Standard	G3
Resolution	G3: 8×3.85/mm•200×100 dpi (Standard), 8×7.7/mm•200×200 dpi (Detail), 8×15.4/mm•200×400 dpi (Fine), 16×15.4/mm•400×400 dpi (Super Fine: optional expansion memory required)
Transmission time	G3: 3 seconds at 28,800 bps, Standard resolution
Data compression method	MH, MR, MMR, JBIG (optional fax function upgrade unit required)
Maximum original size	Standard size: A3, 11"×17" Irregular size: 304×432 mm/12"×17"
Maximum scanning size	297×1,200 mm/11"×47"
Print process	Printing on standard paper using a laser
Transmission speed	G3: 33,600/31,200/28,800/26,400/24,000/21,600/19,200/16,800/14,400/12,000/9,600/7,200/4,800/2,400 bps (auto shift down system)

v Power Consumption

Standby mode	230 W
Transmission	230 W
Reception	230 W
Maximum power consumption	1,440 W
Low power mode/sleep mode	20 W or less

v Internet Fax Transmission and Reception

Network	LAN : Local Area Network Ethernet/10Base-T, 100Base-TX, IEEE1394 (IP over 1394), IEEE802.11b (wireless LAN)
Transmit function	E-mail
Scan line density	Standard (200 × 100 dpi), Detail (200 × 200 dpi)
Original size : Scanning width	A4 : 210 mm (8.3 in.) (Originals larger than A4 size is reduced in size when transmitted.)

Communication Protocols	<ul style="list-style-type: none"> • Transmission SMTP, TCP/IP • Reception POP3, SMTP, IMAP4, TCP/IP
E-mail format	Single/Multi-part, MIME Conversion Attached file forms: TIFF-F (MH compression)
Authentication method	SMTP-AUTH, POP before SMTP, A-POP
Internet communication	Send and receive e-mail with a computer that has an e-mail address
E-mail send functions	Automatic conversion of sent documents to e-mail format and e-mail transmission. Memory transmission only.
E-mail receive functions	Automatic detection and printing of appended TIFF-F (MH) files and ASCII text. Memory reception only.

Compatible Machines









This machine is compatible to machines having the following specifications.

Communication protocols	<ul style="list-style-type: none"> • Transmission SMTP • Reception POP3, SMTP
E-mail format	<ul style="list-style-type: none"> • Format MIME, Base64 • Content-Type Image/tiff Multipart/mixed [text/plain, Image/tiff] (attached file forms)
Data format	<ul style="list-style-type: none"> • Profile TIFF Profile S • Coding MH • Original size A4 • Resolution (dpi) 200×100/200×200 or 204×98/204×196

Acceptable Types of Originals

Make sure your originals are completely dry before setting them in the machine. Wet ink or correcting fluid from originals will mark the exposure glass and affect the resulting image.

Acceptable original sizes

Where original is set	Acceptable original size	Maximum number of sheets	Paper thickness
Exposure glass	Up to A3 (297×420 mm), 11"×17" (279×432 mm)	1	----
ADF, one-sided document	Fax transmission: A5  to A3  (up to 1,200 mm long) 8"×5 ¹ / ₂ "  to 11"×17" 	80 sheets (80 g/m ² , 20 lb)	40-128 g/m ² (11-34 lb)
ADF, two-sided document	Fax transmission: A5  to A3  (up to 432 mm long) 8"×5 ¹ / ₂ "  to 11"×17" 	80 sheets (80 g/m ² , 20 lb)	52-105 g/m ² (14-28 lb)

Paper size and scanned area

v Exposure Glass

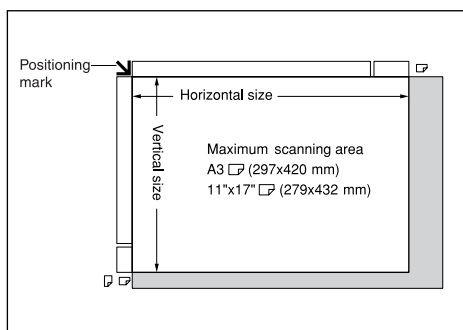

v ADF

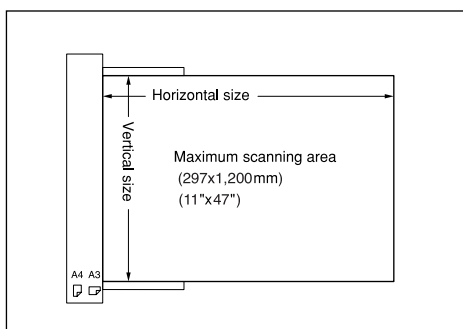

Limitation

- r There may be a difference in the size of the image when it is printed at the destination.
- r If you place an original larger than A3, 11"×17" on the exposure glass, only an A3, 11"×17" area is scanned.

Note

- r Even if an original is correctly placed on the exposure glass or in the ADF, a margin of 3 mm (0.1") around each edge of the original may not be sent.
- r If the receiver uses paper of a smaller width than the original, the image will be reduced to fit that paper. See p.74 "Auto Reduce".
- r The machine detects paper sizes in the following ways:
 - When you place an original in the ADF, an original wider than about 264 mm (10.4") is scanned as A3, 11"×17" size.
An original narrower than about 230 mm (9.1") will be sent as 8¹/₂"×11" or 8¹/₂"×14" size, and an original narrower than about 264 mm (10.4") is scanned as B4 JIS.
Originals up to 1,200 mm (47.2") in length can be scanned.
 - Refer to the table below for sizes the machine can detect when you place an original on the exposure glass. Because the machine scans non-standard size documents in a standard size, part of the image may be truncated depending on the length of the document. For details about how to set non-standard size documents, see p.18 "Setting a Scan Area", *Facsimile Reference* <Basic Features>.

v Metric Version

		Length *1			
		-249 mm	249 mm-274 mm	274 mm-316 mm	316 mm-
Width	-243 mm	×	B5 JIS	A4	F
	243 mm-268 mm	B5 JIS	B4 JIS	B4 JIS	B4 JIS
	268 mm-	A4	A3	A3	A3

v Inch Version

		Length *1			
		-9.8"	9.8"-10.8"	10.8"-12.4"	12.4"-
Width	-9.6"	×	×	8 ¹ / ₂ "×11"	F
	9.6"-10.6"	11"×8 ¹ / ₂ "	11"×17"	11"×17"	11"×17"
	10.6"-	11"×8 ¹ / ₂ "	11"×17"	11"×17"	11"×17"

× - Unable to auto detect

*1 Normally a length of about 420 mm (16.5") can be scanned; however, it is only possible to specify a scanning size up to 432 mm (17").



Maximum scan area

The maximum scan area is shown below:

- Memory Transmission: 297×1,200 mm/11"×47" (W×L) from the ADF
- Immediate Transmission: 297×1,200mm/11"×47" (W×L) from the ADF



Note

- r During Immediate Transmission, the length of the scanning range can become narrower than 1,200 mm (47"), depending on the character size as well as the settings on the destination machine.
- 297×432 mm/11"×17" (W×L) (from the exposure glass)

Maximum Values

The following list contains the maximum value for each item.

Note

- r The maximum number of pages that can be stored or transmitted may decrease depending on the contents of documents.

Item	Standard	With optional unit		
		Fax function upgrade unit	Expansion memory	Expansion memory + fax function upgrade unit
Memory	4 MB	4 MB	28 MB	28 MB
The number of pages that you can store in memory (Using A4 size Standard <ITU-T #4Chart>)	Approx. 320	Approx. 320	Approx. 2,240	Approx. 2,240
Total number of all documents	400	800	400	800
The number of pages per file	1,000	1,000	1,000	1,000
The number of pages for all files	1,000	1,000	3,000	3,000
The number of destinations you can specify for one file	500	500	500	500
The number of destinations you can specify for all files	500	2,000	500	2,000
The number of Quick Dials you can program *1	500	1,200	500	1,200
The number of Group Dials you can program	100	100	100	100
The number of destinations you can program in a group	500	500	500	500
The number of digits for Dials	128	128	128	128
The number of Programs you can register	100	200	100	200
The number of Auto Documents you can program	6	18	6	18

Item	Standard	With optional unit		
		Fax function upgrade unit	Expansion memory	Expansion memory + fax function upgrade unit
The number of Standard Message Stamps you can program	3	3	3	3
The number of transmission records the machine can store	200	1,000 * ²	200	1,000 * ²
The number of stored documents you can specify at one time	1,000	1,000	1,000	1,000
The number of stored documents you can send at one time	30	30	30	30
The number of pages that you can store in the Document Server (Using ITU-T #4Chart)	Approx. 9000	Approx. 9,000	Approx. 9,000	Approx. 9,000
The number of pages you can store in the Document Server for one document	1,000	1,000	1,000	1,000

*¹ With the optional printer/scanner unit or network board, a maximum of 2000 destinations can be programmed.

*² This indicates the number of transmission records that you can check using SmartNetMonitor for Admin. From the machine you can check up to 400 communication records (transmission plus reception).

INDEX

- 180-Degree Rotation Printing, 98
- 2-Sided Printing, 85

A

- Address Book, 116
- Authorized Reception, 164
- Auto Document, 65, 150
 - Changing*, 150
 - Deleting*, 151
 - Sending*, 65
 - Storing*, 150
- Auto Fax Reception Power-up, 95
- Automatic Redial, 78
- Auto Reduce, 74

B

- Basic Transmission, 112
- Batch Transmission, 78
- Book Fax, 61
- Box Setting, 148, 172

C

- Canceling
 - Transmission*, 19
- Center Mark, 96
- Chain Dial, 47
- Checkered Mark, 96
- Checking
 - Transmission Result (TX File Status)*, 31
- Combine 2 originals, 85
- Combine Two originals, 99
- Communication Failure Report, 83
- Communication Information, 27
- Confidential File Report, 37
- Confidential ID, 182
- Confidential Message, 36
- Confidential Transmission, 8
- Counters, 147, 154
- Cover sheet, 113

D

- Default ID/Free Polling Reception, 13
- Default ID Transmission, 10, 11, 75
- Deleting
 - Information Box Messages*, 45
 - programmed destinations*, 117
- Destination
 - Adding*, 21
 - Checking*, 18
 - Deleting*, 20
- Displaying the Memory Status, 33
- Document Server, 129
 - Delete File*, 134
 - Manage File*, 132
 - Storing a Document*, 130
- Dual Access, 79

E

- ECM (Error Correction Mode), 78, 147, 158
- Economy Transmission Time, 3
- E-mail transfer, 95
- End Receiver, 155
- Error Mail Notification, 189
- Error Report, 187
- Error Report (Mail), 189
- Expansion Memory, 195
- Extra G3 Interface Unit, 195

F

- Fax Function Upgrade Unit, 195
- Fax Header Print, 73
- File
 - Printing*, 23
 - Printing a List of Files in Memory (Print TX File List)*, 25
 - Re-sending*, 24
- Forwarding, 91, 147, 155, 165
- Free Polling Transmission, 10, 11
- Full/Partial agreement, 163

G

- General Settings/Adjustment, 142

H

- Handy Dialing Functions, 47

I

ID Override Polling Reception, 13
ID Override Transmission, 10
Image Rotation, 79, 99
Immediate Reception, 85
Information Boxes, 42
 Changing, 175
 Deleting, 177
 Printing, 181
 Programming, 175
 Storing Messages, 42

J

JBIG, 80, 95
 Reception, 95
 Transmission, 80
Journal, 27
Journal by E-mail, 81
Journal by E-mail, Transmitting, 80
Just size printing, 103

K

Key Operator Code, 140
Key Operator Settings, 147
Key Operator Tools List, 147
Keystroke Program, 125

L

Label Insertion, 74
LAN-Fax Features, 107
LAN-Fax Operation Messages, 119
LAN-Fax Properties, Setting, 111
Line Type
 Changing, 59
 Selecting, 193

M

Manual Dial, 58
Maximum Value, 201
Memory Lock, 38, 157, 165
Memory Lock ID, 183
Memory Reception, 85
Memory Status, 33
Memory Storage Report, 82
More Transmission Functions, 77
Multi-copy, 85
Multi-copy Reception, 98
Multi-port, 59
Multistep Transfer, 90

O

On Hook Dial, 56
Optional Equipment, 195
Originals, 198
Output Tray, 105

P

Page Reduction, 101
Page Separation and Length Reduction, 100
Paper Tray, 144
Parallel Memory Transmission, 77
Parameter Setting, 147
Personal Boxes, 40, 172, 174
 Changing, 172
 Deleting, 174
 Printing, 181
 Programming, 172
Polling ID, 183
Polling Reception, 13
Polling Reserve Report, 15
Polling Result Report, 15
Polling Transmission, 10
Polling Transmission Clear Report, 12
Power Failure Report, 187
Print 2 Sided, 165
Print Completion Beep, 96
Printed Report, 82
Printing
 Box List, 181
 Confidential Message, 36
 File Received with Memory Lock, 38
 Information Box Messages, 44
 Journal, 27
 Options, 96
 Personal Box Messages, 41
 Special Sender List, 171
Printing and Saving, 115
Priority trays, 103
Programs, 125
 Changing, 125
 Deleting, 127
 Registering, 125
PWD Code, 51

Q

Quick Operation key, 143

R

RDS (Remote Diagnostic System), 188
Receiving Station, 52, 89
Reception, 85

- Reception Features*, 85
- Reception File Print Quantity*, 165
- Reception Functions*, 89
- Reception Reverse Printing*, 165
- Reception Settings*, 144
- Reception Time*, 97

Reception Result (RX File Status), 32
Redial, 47
Reduced Image Transmission, 74
Report, 82, 187

- Communication Failure Report*, 83
- Error Report*, 187
- Memory Storage Report*, 82
- Power Failure Report*, 187
- Transmission Result Report (Immediate Transmission)*, 83
- Transmission Result Report (Memory Transmission)*, 82

Requesting Party, 52, 89
Reverse Order Printing, 85, 100
RX File Status, 32

S

Scan Size, 152

- Changing*, 152
- Deleting*, 152
- Programming*, 152

Selecting

- Dial/Push Phone*, 184

Sender Stamp, 74
Send Later, 3
SEP Code, 50
Server-Generated Error E-mail, 189
SID Code, 50
Simultaneous Broadcast, 79
SMTP, 94
SMTP reception, 93
Special Senders, 163
Special Senders to Treat Differently, 163
Specifications, 196
Stamp, 72
Stamp Cartridge, 191
Standard Messages, 149

- Deleting*, 149
- Programming*, 149

Standard Message Stamp, 64

SUB Code, 49, 92
Substitute Reception, 86
Switches and Bits, 159

T

Telephone Line, 192
Transfer Boxes, 180

- Changing*, 178
- Deleting*, 180
- Printing*, 181
- Programming*, 178

Transfer Report, 181
Transfer Request, 52
Transfer Result Report, 90
Transfer Result Report (transfer request by e-mail), 91
Transferring, 93
Transfer Station, 52, 89
Transmission Features, 47
Transmission Mode, 3
Transmission Options, 73
Transmission Result Report (Immediate Transmission), 83
Transmission Result Report (Memory Transmission), 82
Transmission Time

- Changing*, 22

Transmission with Image Rotation, 79
Tray for Lines, 105
Tray Shift, 105
TSI Print, 101
Two-Sided Printing, 97
Two-Sided Transmission, 62
TX File, 18
TX File Status, 31

U

User Parameter List, 159
User Parameters, 159

MEMO



Printer/Scanner Unit Type 2045e



Operating Instructions Printer Reference 1



-
- 1 Getting Started
 - 2 Preparing to Print

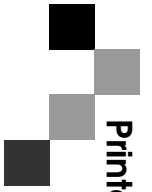

Printer/Scanner Unit Type 2045e Operating Instructions Printer Reference 1

Introduction

This manual describes detailed instructions on the operation and notes about the use of this machine. To get maximum versatility from this machine all operators are requested to read this manual carefully and follow the instructions. Please keep this manual in a handy place near the machine.

Important

Contents of this manual are subject to change without prior notice. In no event will the company be liable for direct, indirect, special, incidental, or consequential damages as a result of handling or operating the machine.

Warning:

Use of controls or adjustment or performance of procedures other than those specified in this manual might result in hazardous radiation exposure.

Trademarks

Microsoft®, Windows® and Windows NT® are registered trademarks of Microsoft Corporation in the United States and/or other countries.

Adobe®, PostScript®, Acrobat®, PageMaker® and Adobe Type Manager are registered trademarks of Adobe Systems Incorporated.

PCL® is a registered trademark of Hewlett-Packard Company.

AppleTalk, Apple, Macintosh and Mac are registered trademarks of Apple Computer, Incorporated.

IPS-PRINT™ Printer Language Emulation Copyright© 2000, Oak Technology, Inc., All Rights Reserved.

UNIX is a registered trademark in the United States and other countries, licensed exclusively through X/Open Company Limited.

Bluetooth is a Trademark of the Bluetooth SIG, Inc. (Special Interest Group) and licensed to RICOH company limited.

Copyright © 2001 Bluetooth SIG, Inc.

The Bluetooth Trademarks are owned by Bluetooth SIG, Inc. USA

Other product names used herein are for identification purposes only and might be trademarks of their respective companies. We disclaim any and all right in those marks.

The proper names of the Windows operating systems are as follows:

- The product name of Windows® 95 is Microsoft® Windows® 95
- The product name of Windows® 98 is Microsoft® Windows® 98
- The product name of Windows® Me is Microsoft® Windows® Millennium Edition (Windows Me)
- The product name of Windows® 2000 are as follows:
Microsoft® Windows® 2000 Advanced Server
Microsoft® Windows® 2000 Server
Microsoft® Windows® 2000 Professional
- The product name of Windows® XP are as follows:
Microsoft® Windows® XP Professional
Microsoft® Windows® XP Home Edition
- The product names of Windows Server™ 2003 are as follows:
Microsoft® Windows Server™ 2003 Standard Edition
Microsoft® Windows Server™ 2003 Enterprise Edition
Microsoft® Windows Server™ 2003 Web Edition
- The product name of Windows® NT are as follows:
Microsoft® Windows NT® Server 4.0
Microsoft® Windows NT® Workstation 4.0

Notes:

Some illustrations in this manual might be slightly different from the machine.

Certain options might not be available in some countries. For details, please contact your local dealer.

Note to users in the United States of America

Notice:

This equipment has been tested and found to comply with the limits for a Class B digital device, pursuant to Part 15 of the FCC Rules. These limits are designed to provide reasonable protection against harmful interference in a residential installation. This equipment generates, uses and can radiate radio frequency energy and, if not installed and used in accordance with the instructions, may cause harmful interference to radio communications.

However, there is no guarantee that interference will not occur in a particular installation. If this equipment does cause harmful interference to radio or television reception, which can be determined by turning the equipment off and on, the user is encouraged to try to correct the interference by one more of the following measures:

Reorient or relocate the receiving antenna.

Increase the separation between the equipment and receiver.

Connect the equipment into an outlet on a circuit different from that to which the receiver is connected.

Consult the dealer or an experienced radio/TV technician for help.

Caution

Changes or modifications not expressly approved by the party responsible for compliance could void the user's authority to operate the equipment.

Caution (in case of IEEE1284 environment) :

Properly shielded and grounded cables and connectors must be used for connections to host computer (and/or peripheral) in order to meet FCC emission limits.

Use a commercially available shielded cable.

Caution (in case of 100BaseTX environment):

Network interface cable with ferrite core must be used for RF interference suppression.

Use a commercially available cable after attaching the ferrite core provided.

Caution (in case of IEEE1394 environment):

Use the cable provided with the machine.

Caution (in case of USB2.0 environment):

Use a commercially available shielded USB cable.

Declaration of Conformity

Product Name: Printer Controller

Model Number: Printer/Scanner Unit Type 2045e

Responsible party: Ricoh Corporation

Address: 5 Dedrick Place, West Caldwell, NJ 07006

Telephone number: 973-882-2000

This device complies with part 15 of FCC Rules.

Operation is subject to the following two conditions:

1. This device may not cause harmful interference, and
2. this device must accept any interference received, including interference that may cause undesired operation.

TABLE OF CONTENTS

Manuals for This Machine	1
How to Read This Manual	3
1. Getting Started	
<hr/>	
Control Panel.....	5
Display Panel	6
2. Preparing to Print	
<hr/>	
Preparing the Machine	10
Connecting the Machine	10
Setting Paper on the Bypass Tray	12
Installing the Software.....	15
Auto Run	15
Quick Install.....	16
Installing the PCL 6/5e and RPCS™ Printer Driver	18
Setting Up Options - PCL 6/5e and RPCS.....	22
Installing the PostScript 3 Printer Driver	23
Mac OS - Installing the PostScript 3 Printer Driver and Utilities.....	29
Mac OS X - Installing the PostScript 3 Printer Driver.....	31
Installing the Printer Driver Using USB	32
Installing the Printer Driver Using IEEE 1394	34
Installing SmartNetMonitor for Client/Admin	37
Installing Font Manager 2000.....	38
Using Adobe PageMaker Version 6.0, 6.5, or 7.0.....	38
Software and Utilities Included on the CD-ROM	40
Printer Drivers	40
Software and Utilities	41
INDEX.....	43

Manuals for This Machine

The following manuals describe the operational procedures of this machine. For particular functions, see the relevant parts of the manual.

Note

- Manuals provided are specific to machine type.
- Adobe Acrobat Reader is necessary to view the manuals as a PDF file.
- Two CD-ROMs are provided:
 - CD-ROM 1“Operating Instructions for Printer/Scanner”
 - CD-ROM 2“Scanner Driver & Document Management Utilities”

❖ **General Settings Guide**

Provides an overview of the machine.

It also describes System Settings (such as paper trays and user codes settings), Document Server functions, and troubleshooting.

❖ **Network Guide (PDF file - CD-ROM1)**

Describes procedures for configuring the machine and computers in a network environment.

❖ **Copy Reference**

Describes operations, functions, and troubleshooting for the machine’s copier function.

❖ **Facsimile Reference <Basic Features>**

Describes operations, functions, and troubleshooting for the machine’s facsimile function.

❖ **Facsimile Reference<Advanced Features>**

Describes advanced functions and settings for key operators.

❖ **Printer Reference 1 (this manual)**

Describes system settings and operations for the machine’s printer function.

❖ **Printer Reference 2 (PDF file - CD-ROM1)**

Describes operations, functions, and troubleshooting for the machine’s printer function.

❖ **Scanner Reference (PDF file - CD-ROM1)**

Describes operations, functions, and troubleshooting for the machine’s scanner function.

❖ **Manuals for DeskTopBinder V2 Lite**

DeskTopBinder V2 Lite is a utility included on the CD-ROM labeled “Scanner Driver & Document Management Utilities”.

- DeskTopBinder V2 Lite Setup Guide (PDF file - CD-ROM2)
Describes installation of, and the operating environment for DeskTopBinder V2 Lite in detail. This guide can be displayed from the **[Setup]** dialog box when DeskTopBinder V2 Lite is installed.
- DeskTopBinder V2 Lite Introduction Guide (PDF file - CD-ROM2)
Describes operations of DeskTopBinder V2 Lite and provides an overview of its functions. This guide is added to the **[Start]** menu when DeskTopBinder V2 Lite is installed.
- Auto Document Link Guide (PDF file - CD-ROM2)
Describes operations and functions of Auto Document Link installed with DeskTopBinder V2 Lite. This guide is added to the **[Start]** menu when DeskTopBinder V2 Lite is installed.

❖ **Manuals for ScanRouter V2 Lite**

ScanRouter V2 Lite is a utility included on the CD-ROM labeled “Scanner Driver & Document Management Utilities”.

- ScanRouter V2 Lite Setup Guide (PDF file - CD-ROM2)
Describes installation of, settings, and the operating environment for ScanRouter V2 Lite in detail. This guide can be displayed from the **[Setup]** dialog box when ScanRouter V2 Lite is installed.
- ScanRouter V2 Lite Management Guide (PDF file - CD-ROM2)
Describes delivery server management and operations, and provides an overview of ScanRouter V2 Lite functions. This guide is added to the **[Start]** menu when ScanRouter V2 Lite is installed.

❖ **Other manuals**

- PS3 Supplement (PDF file - CD-ROM1)
- UNIX Supplement (available from an authorized dealer, or as a PDF file on our Web site)

How to Read This Manual

Symbols

In this manual, the following symbols are used:

 **WARNING:**

This symbol indicates a potentially hazardous situation which, if instructions are not followed, could result in death or serious injury.

 **CAUTION:**

This symbol indicates a potentially hazardous situation which, if instructions are not followed, may result in minor or moderate injury, or damage to property.

* The statements above are notes for your safety.

 **Important**

If this instruction is not followed, paper might misfeed, originals might be damaged, or data might be lost. Be sure to read this.

 **Preparation**

This symbol indicates prior knowledge or preparation is required before operation.

 **Note**

This symbol indicates precautions for operation, or actions to take after mal-operation.

 **Limitation**

This symbol indicates numerical limits, functions that cannot be used together, or conditions in which a particular function cannot be used.

 **Reference**

This symbol indicates a reference.

[]

Keys and buttons that appear on the computer's display.

Keys that appear on the machine's display panel.

[]

Keys built into the machine's control panel.

Keys on the computer's keyboard.

1. Getting Started

Control Panel

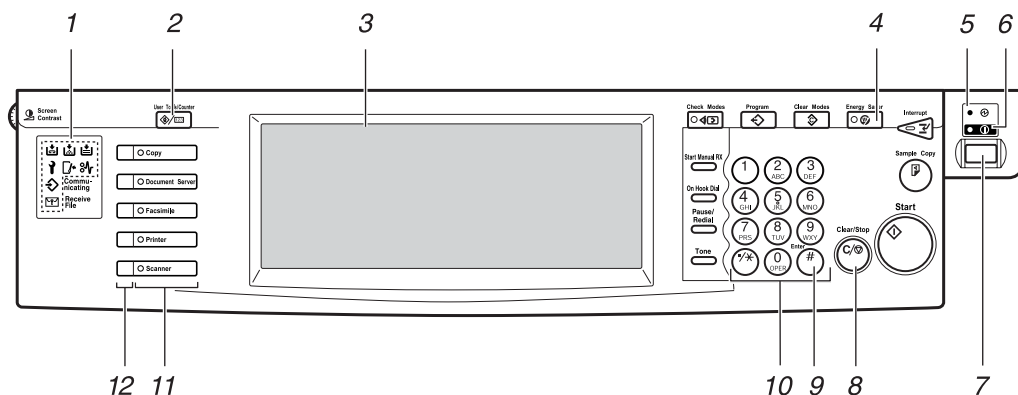

1. Indicators

Displays errors and machine status.

↔: Data In indicator

The Data In indicator shows the status of data reception from a computer.

- Blinks when data is being received.
- Lights when there is data remaining to be printed.

See "Multi-Access", *General Settings Guide*.

↑: Service call indicator

⚡: Misfeed indicator

☐: Open Cover indicator

📄: Add Staple indicator

🖨️: Add Toner indicator

📄: Load Paper indicator

See "Control Panel", *General Settings Guide*.

2. [User Tools/Counter] key

- User Tools
Press to change default settings and conditions to your requirements.
- Counter
Press to display or print the total number of copies made.

3. Display panel

Displays operation status, error messages, and function menus. See p.6 "Display Panel".

4. [Energy Saver] key

Press to switch to and from Energy Saver mode.

📌 Note

- ☐ This key is ineffective during System Settings (User Tools) operations.

5. Main power indicator

This indicator lights when the main power switch is turned on.

⚠ Important

- ☐ Do not turn off the main power switch while the Power indicator is lit or blinking. Doing so may damage the hard disk.

6. Power indicator

This indicator lights when the operation switch is turned on.

7. Operation switch

Press this switch to turn the power on (the Power indicator goes on). To turn the power off, press this switch again (the Power indicator goes off).

8. [Clear/Stop] key

Press to cancel the entered data.

9. [#] key

Press after entering a value.

10. Number keys

Press to enter a value for various settings.

11. Function keys

Press to switch between the "Copy", "Document Server", "Facsimile", "Printer", and "Scanner" screens.

The indicator for the selected function lights.

12. Function status indicators

These show the status of the above functions:

- Green: the function is active.
- Red: the function has been interrupted.

Display Panel

This section describes configuration using the display panel when the printer function is selected.

Important

- ❑ The machine switches to offline when you make settings when the machine is online. After you complete the setting, the machine switches to online automatically.
- ❑ If you make a setting when the machine is offline, it will stay offline afterward.
- ❑ The function items displayed serve as selector keys. You can select or specify an item by pressing it lightly.
- ❑ When you select or specify an item on the display panel, it becomes highlighted.
- ❑ Keys dimmed (for example, OK) cannot be used.

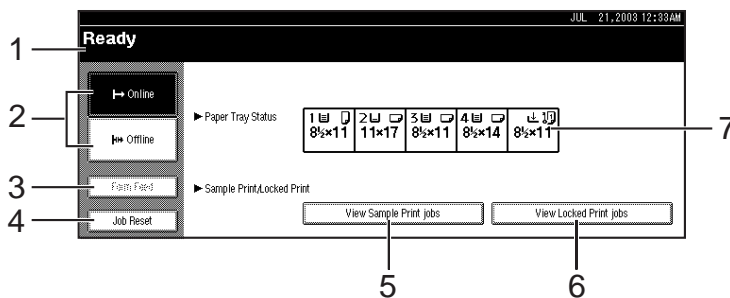

1. Operational status or messages

Displays current machine status, such as "Online", "Offline", and "Printing". Information about the print job (user ID and document name) appears in this section.

2. [↔ Online] key/[↔ Offline] key

When you press these keys, the machine switches between online and offline.

When the machine is online, it can receive data from the computer.

When the machine is offline, it cannot receive data from the computer.

3. [Form Feed] key

Press to print all the data left in the machine's input buffer.

Note

- When the machine is online, the status appears dimly.
- This function is not available with the RPCS™ printer language.

4. [Job Reset] key

Press to cancel the current print job.

If you press it when the machine is offline and Hex Dump is selected, Hex Dump is canceled. See "Printer Features Parameters", *Printer Reference 2*.

Note

- When the power is turned on, the copier display is shown. This is a factory default. This initial setting can be changed. See "User Tools (System Settings)", *General Settings Guide*.
- If the machine cannot be switched offline, select **[Printer]** for **[Print Priority]** on **[General Features]** in the System Settings. For details about the setting, see "User Tools (System Settings)", *General Settings Guide*.

5. [View Sample Print jobs] key

Press to print or change the number of remaining sets of Sample Print jobs sent from a computer.

6. [View Locked Print jobs] key

Press to print the Locked Print jobs sent from a computer.

7. [▶Paper Tray Status] key

The paper tray settings appear.

2. Preparing to Print

This section gives instructions for connecting the machine and computer, configuring the machine, and installing software.

❖ When operating the machine with a parallel connection, USB connection, or SCSI print (IEEE 1394) connection

- Connect the machine and computer using a parallel cable, a USB cable, or an IEEE 1394 (SCSI print) cable.

Reference

For more information, see p.10 “Connecting the Machine”.

- Install a printer driver from the CD-ROM.

Reference

For more information, see p.15 “Installing the Software”.

❖ When operating the machine under a network environment

- Configure the network using the machine's control panel.

Reference

For more information, see "Network Configuration", *Network Guide*.

- Install a printer driver and other utilities from the CD-ROM.

Reference

For more information, see p.15 “Installing the Software”.

Note

- ❑ "Network environment" describes a situation where the machine is connected to a computer via Ethernet, wireless LAN, or IEEE 1394 (IP over 1394).
- ❑ The optional IEEE 1394 board for SCSI print connection and the optional USB 2.0 board for USB connection cannot be both installed in the machine.

Preparing the Machine

Connecting the Machine

Reference

For information about connection using Ethernet and wireless LAN, see "Confirming the Connection", *Network Guide*.

For information about connection using Bluetooth™, see the manual that comes with the optional Bluetooth interface unit.

Requirements

Before using this machine, make sure all environmental and electrical requirements are met. Connect the machine to the host computer using the parallel port, network interface unit, or both.

Make sure all cables, connectors, and electrical outlets necessary to attach the machine to the host computer or network are at hand.

Connecting the Machine to the host using the parallel cable/SCSI print (IEEE 1394) cable

Connect the machine to the host computer using the parallel port or optional IEEE 1394 interface board. This machine does not come with a parallel cable to connect the machine to the host computer.

The machine's parallel interface is a standard bidirectional interface. It requires a standard IEEE 1284 compliant 36-pin parallel cable and a parallel port on the host computer. Make sure you purchase the appropriate cable for the machine and your computer.

Note

- Do not use a parallel cable that is longer than 3 meters (10 feet).
- Rating voltage of the interface connector: Max. DC 5V

Follow the procedure below to connect the machine to the host computer using a parallel cable or IEEE 1394 interface cable.

Important

- Before connecting the machine and a computer using an interface cable, make sure the machine is not operating, and then turn off the main power switches of the machine and computer.
- Be sure to use a specified interface cable. Other cables may cause radio interference.

1 Turn off the main power switches of the machine and computer.

Important

- Before turning off the main power switch, see "Turning Off the Power", *General Settings Guide*.

2 Plug the cable into the connector on the machine's interface.

❖ Parallel Connection

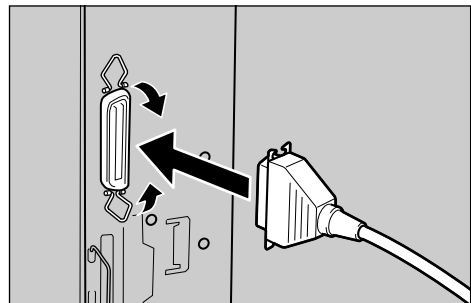

❖ SCSI Print (IEEE 1394) Connection

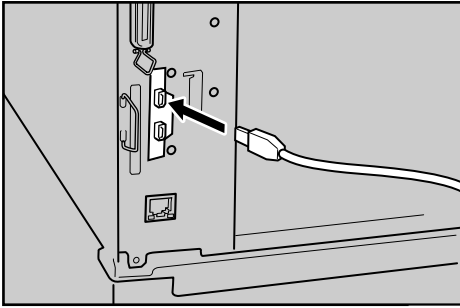

- 3** Plug the other end of the cable into the connector on the computer's interface.
- 4** Turn on the machine's main power switch.
- 5** Turn on the computer.

Note

- When using Windows 95/98 SE/Me or Windows 2000/XP, a printer driver installation screen might appear when the computer is turned on. If this happens, click **[Cancel]** on the screen. For more information, see p.15 "Auto Run".

The machine and computer are now connected. The printer driver must be installed next. For information about how to install the printer driver, see p.15 "Installing the Software".

Connecting the machine to the host using a USB cable

You can connect the machine to the host computer using a USB interface cable when the optional USB 2.0 interface board is installed in the machine.

This machine does not come with a USB interface cable. Make sure you purchase the appropriate cable for the machine and your computer.

Follow the procedure below to connect the machine to the host computer using a USB interface cable.

- 1** Connect the USB 2.0 interface cable to the USB port on the right side of the machine's back cover.

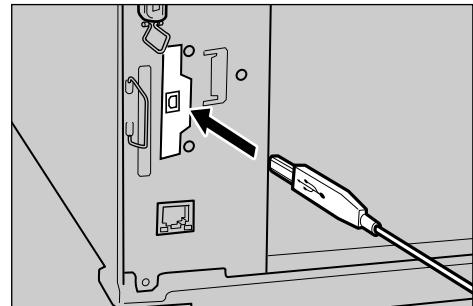

- 2** Connect the other end to the USB port on the host computer.

Note

- The optional USB 2.0 interface board is supported by Windows 98 SE/Me, Windows 2000/XP, Mac OS 9.x, and Mac OS X Classic mode.

- For Windows 98 SE/Me: Make sure to install "USB Printing Support". If USB 2.0 is used with Windows 98 SE/Me, only a speed equal to that of USB 1.1 is possible.
- For Macintosh: Macintosh supports only the standard USB port. If USB 2.0 is used with a Macintosh, only a speed equal to that of USB 1.1 is possible.

Setting Paper on the Bypass Tray

This section gives instructions for setting paper on the bypass tray. Use the bypass tray to print onto OHP transparencies, labels, thick paper, and envelopes that cannot be loaded in the paper tray.

Reference

For details about setting paper in the regular paper tray, see *General Settings Guide*.

Note

- ❑ When loading letterhead paper, pay attention to its orientation. See “Orientation-Fixed Paper or Two-Sided Paper”, *General Settings Guide*.
- ❑ Paper within the following dimensions can be set in the bypass tray:
 - Vertical: 100.0-297.0 mm (3.93 in.-11.69 in.)
 - Horizontal: 148.0-600.0 mm (5.83 in.-23.62 in.)
- ❑ Be sure to set the paper with the side you want to print facing down in the bypass tray.
- ❑ When loading OHP transparencies or thick paper in the bypass tray, make the paper setting using the control panel or printer driver.
- ❑ The number of sheets that can be loaded in the bypass tray depends on the paper type.

Limitation

- ❑ The following functions are disabled when printing from the bypass tray:
 - Duplex Printing
 - Auto Tray Select

- Auto Tray Switching
- Rotating Collate
- Staple (when the optional unit is installed)
- Punch (when the optional unit is installed)

Important

- ❑ When printing using the printer function, original images are always rotated by 180 degrees (the orientation of images to be printed is opposite to that of the copier function). When printing onto paper with specific orientation requirements, such as envelopes and letterheads, make sure to rotate the paper feed orientation to 180 degrees.
- ❑ Be sure to set the paper size using the printer driver when printing data from the computer. The paper size set using the printer driver has priority over the one set using the display panel.

1 Open the bypass tray.

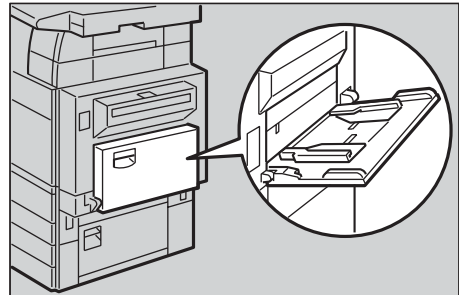

2 Adjust the paper guides to the paper size.

Important

- ❑ If the paper guides are not flush against the paper, skewed images or paper misfeeds might occur.

- 3** Gently insert paper face down into the bypass tray until the beeper sounds.

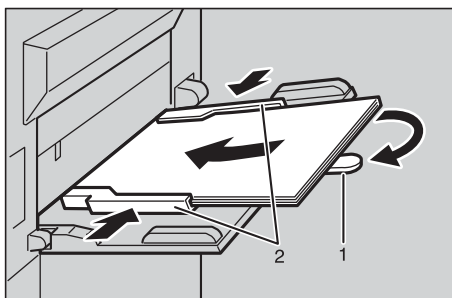

1. Extender
2. Paper guides

Note

- The beeper will not sound if it is turned off. Gently insert paper until it stops.
- Do not stack paper over the limit mark, otherwise a skewed image or misfeeds might occur.
- Open out the extender to support paper sizes larger than A4 , 8¹/₂"x11" .
- Fan the paper to get air between the sheets to avoid a multi-sheet feed.
- When setting an OHP transparency, make sure that its front and back sides are properly positioned.
- Select paper type when printing onto OHP transparencies or thick paper (over 105g/m²). For details, see p.14 "Setting thick paper or OHP transparencies".

- 4** Select the paper size.

Note

- You can set paper size using the printer driver. The following procedures are not necessary when setting paper size using the printer driver.

- The paper size set using the printer driver has priority over that set using the display panel.
- When the printer driver is not used, make settings using the display panel.

Reference

For printer driver settings, see the printer driver Help.

For details about setting custom sizes, see p.14 "Setting custom size paper".

- A** Press the **[User Tools/Counter]** key on the control panel.



- B** Press **[Printer Features]**.

- C** Press the **[Paper Input]** tab.



- D** Press **[Bypass Paper Size]**.

- E** Select the paper size.

Note

- Press **[▲Prev.]** or **[▼Next.]** to scroll through the list.
- When printing onto thick paper or OHP transparencies, select paper type. For details, see p.14 "Setting thick paper or OHP transparencies".

- F** Press **[OK]**.

- G** Press the **[User Tools/Counter]** key.

Setting custom size paper

Note

- ❑ Custom sizes can also be set using the printer driver. The following procedures are not necessary when setting custom sizes using the printer driver.
- ❑ Custom size settings set using the printer driver have priority over those set using the machine's display panel.
- ❑ When the printer driver is not used, make settings using the display panel.

Reference

For printer driver settings, see the printer driver Help.

- 1 Press the **[User Tools/Counter]** key on the control panel.
- 2 Press **[Printer Features]**.
- 3 Press the **[Paper Input]** tab.
- 4 Press **[Bypass Paper Size]**.
- 5 Press **[Custom Size]**.
- 6 Enter the vertical size of the paper using the number keys, and then press **[#]**.

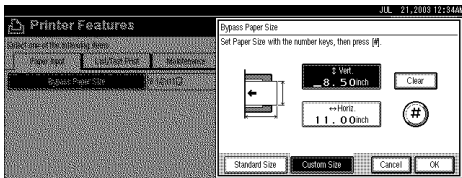

- 7 Enter the horizontal size of the paper using the number keys, and then press **[#]**.
- 8 Press **[OK]**.
The paper sizes entered are displayed.
- 9 Press the **[User Tools/Counter]** key.

Setting thick paper or OHP transparencies

Note

- ❑ Paper settings can also be set using the printer driver. The following procedures are not necessary when setting paper sizes using the printer driver.
- ❑ Paper size settings set using the printer driver have priority over those set using the machine's display panel.
- ❑ When the printer driver is not used, make settings using the display panel.

Reference

For printer driver settings, see the printer driver Help.

- 1 Press the **[User Tools/Counter]** key on the control panel.
- 2 Press **[System Settings]**.
- 3 Press the **[Tray Paper Settings]** tab.
- 4 Press **[▼Next.]** to scroll through the list.
- 5 Press **[Paper Type: Bypass tray]**.

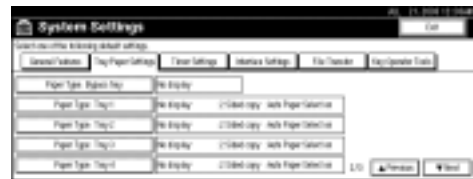

- 6 Select **[OHP]** or **[Thick Paper]**
- 7 Press **[OK]**.
The paper type selected is displayed.
- 8 Press the **[User Tools/Counter]** key.

Note

- ❑ The settings made will remain valid until they are reset again. After printing on OHP transparencies or thick paper, make sure to clear settings for the next user.

Installing the Software

This manual assumes you are familiar with general Windows procedures and practices. If you are not, see the operating instructions that come with Windows for details.

The procedure for installing the printer driver depends on the connection with the computer. With a parallel or Ethernet connection, Quick Install is also available. With a wireless LAN connection, check the machine and computer are communicating properly and then install the printer driver by following the procedure used for an Ethernet connection.

- For details about the parallel/Ethernet connection, see p.16 “Quick Install” or p.18 “Installing the PCL 6/5e and RPCS™ Printer Driver”.
- For details about the USB connection, see p.32 “Installing the Printer Driver Using USB”.
- For details about the IEEE 1394 connection, see p.34 “Installing the Printer Driver Using IEEE 1394”.

Auto Run

Inserting the CD-ROM into the CD-ROM drive starts the installer automatically. The installer helps you install the following printer drivers and software easily.

Note

- If “plug and play” starts, click **[Cancel]** in **[New Hardware Found]**, **[Device Driver Wizard]** or **[Found New Hardware Wizard]** dialog box, and then insert the CD-ROM. The **[New Hardware Found]**, **[Device Driver Wizard]** or **[Found New Hardware Wizard]** dialog box appears depending on the system version of the Windows 95/98/Me, Windows 2000/XP, or Windows NT 4.0.
- Auto Run might not work automatically with certain operating system settings. If this happens, launch "Setup.exe", located on the CD-ROM root directory.
- If you want to cancel Auto Run, hold down the **[SHIFT]** key (if your operating system is Windows 2000/XP, hold down the left **[SHIFT]** key) while inserting the CD-ROM. Keep the **[SHIFT]** key held down until the computer has finished accessing the CD-ROM.

Limitation

- If your operating system is Windows 2000/XP or Windows NT 4.0, installing software using Auto Run requires Administrator permission. When you install software using Auto Run, log on using an account that has Administrators permission.

The following table shows the printer drivers and software that can be installed using Auto Run:

	Auto Run *1		
	Quick Install		Add Printer and Utility Wizard
	Network connection with TCP/IP	Parallel connection	
PCL 6 printer driver	<input type="radio"/>	<input type="radio"/>	<input type="radio"/>
PCL 5e printer driver			<input type="radio"/>
RPCS™ printer driver	<input type="radio"/>	<input type="radio"/>	<input type="radio"/>
Post-Script 3 printer driver			<input type="radio"/>
LAN-Fax Driver			<input type="radio"/>
Font Manager 2000			<input type="radio"/>
Smart-NetMonitor for Admin			<input type="radio"/>
Smart-NetMonitor for Client	<input type="radio"/>		<input type="radio"/>

*1 Available operating systems are: Windows 95/98/Me, Windows 2000/XP, Windows NT 4.0. Auto Run is unavailable with Macintosh.

Quick Install

Auto Run will start the installer automatically when you insert the CD-ROM into the CD-ROM drive. By selecting Quick Install, you can easily install the PCL 6 printer driver and the RPCS™ printer driver. SmartNet-Monitor for Client can also be installed provided the machine and computer are connected via the network.

Preparation

Before starting installation, close all documents and applications.

Limitation

- The following conditions are required:
 - Windows 95/98/Me, Windows 2000/XP, or Windows NT 4.0

For Ethernet connections:

- The machine must be connected to the network using an Ethernet cable.
- TCP/IP protocol must be configured.
- The IP address must be assigned to both machine and computer.
- The wireless LAN board is installed and the connection is properly made.

For parallel connections:

- The machine must be connected to the computer using a parallel cable.
- Bidirectional transmission must be enabled.

Important

- If your system is Windows NT 4.0, we recommend that you upgrade the Windows NT 4.0 operating system to Service Pack 4 or later before installing the PCL 6/5e or RPCS™ printer drivers. Contact your Windows retailer for more information about latest versions.

Note

- When the machine is connected to the computer using the IEEE 1394 interface or the USB 2.0 interface, Quick Install cannot be used. See p.32 “Installing the Printer Driver Using USB”, p.34 “Installing the Printer Driver Using IEEE 1394”.

1 Quit all applications running.

2 Insert the CD-ROM into the CD-ROM drive.

Auto Run will start the installer.

3 Select a language for the interface language, and then click [OK].

The following languages are available: Cestina (Czech), Dansk (Danish), Deutsch (German), English (English), Espanol (Spanish), Francais (French), Italiano (Italian), Korean (Korean) Magyar (Hungarian), Nederlands (Dutch), Norsk (Norwegian), Polski (Polish), Portugues (Portuguese), Russian (Russian), Suomi (Finnish), Svenska (Swedish)

The default interface language is English.

4 Click [Quick Install].

The software license agreement appears in the [License Agreement] dialog box.

5 After reading through the agreement, click [I accept the agreement] to agree, and then click [Next].

6 Click the machine model you are using when the [Select Printer] dialog box appears.

Note

- For TCP/IP network connection, select the machine whose IP address is displayed in the [Connect To] column.
- For parallel connection, select the machine whose printer port is displayed in the [Connect To] column.

7 Click [Install].

8 Follow the instructions on the screen.

A message prompting you to restart your computer may appear. To complete installation, restart your computer.

Important

- If the machine has options installed, you should make settings for them using the printer driver. See p.22 “Setting Up Options - PCL 6/5e and RPCS”.

Note

- If you want to change the printer name, follow the procedure below:

- **Windows 95/98/Me, Windows 2000, Windows NT 4.0** On the [Start] menu, point to [Settings], and then click [Printers]. The [Printers] window appears. Right-click the machine icon, and then click [Rename].

- **Windows XP Professional**
On the **[Start]** menu, click **[Printers and Faxes]**. The **[Printers and Faxes]** window appears. Right-click the machine icon, and then click **[Rename]**.
- **Windows XP Home Edition**
On the **[Start]** menu, click **[Control Panel]**. Click **[Printers and Other Hardware]**, and then click **[Printers and Faxes]**. The **[Printers and Faxes]** window appears. Right-click the machine icon, and then click **[Rename]**.

Installing the PCL 6/5e and RPCS™ Printer Driver

This section gives basic instructions for installing the PCL 6/5e printer driver and RPCS™ printer driver without using Quick Install. Follow the procedures below, as appropriate.

Reference

See p.16 “Quick Install” to install the PCL 6 printer driver or RPCS™ printer driver using Quick Install.

Limitation

- If your operating system is Windows 2000/XP or Windows NT 4.0, installing a printer driver using Auto Run requires Administrator permission. When you install a printer driver using Auto Run, log on using an account that has Administrator permission.

Important

- If your operating system is Windows NT 4.0, we recommend that you upgrade the Windows NT 4.0 operating system to Service Pack 4 or later before installing the printer drivers. Contact your Windows retailer for more information about latest versions.

Note

- If you want to share the machine on a Windows 2000/XP or Windows NT 4.0 platform, use the **[Sharing]** tab in the printer properties dialog box to specify the additional driver (alternate driver). For details, see the operating instructions that come with Windows 2000/XP, or Windows NT 4.0.
- When prompted for the additional driver (alternate driver) location, select the following folders on the CD-ROM:
 - **Windows 95/98/Me**
PCL 6: \DRIVERS\PCL6\WIN9X_ME\ (Language)\DISK1\
PCL 5e: \DRIVERS\PCL5E\WIN9X_ME\ (Language)\DISK1\
RPCS™: \DRIVERS\RPCS\WIN9X_ME\ (Language)\DISK1\
 - **Windows 2000/XP**
PCL 6: \DRIVERS\PCL6\WIN2K_XP\ (Language)\DISK1\
PCL 5e: \DRIVERS\PCL5E\WIN2K_XP\ (Language)\DISK1\
RPCS™: \DRIVERS\RPCS\WIN2K_XP\ (Language)\DISK1\
 - **Windows NT 4.0**
PCL 6: \DRIVERS\PCL6\NT4\ (Language)\DISK1\
PCL 5e: \DRIVERS\PCL5E\NT4\ (Language)\DISK1\
RPCS™: \DRIVERS\RPCS\NT4\ (Language)\DISK1\

- 1** Quit all applications running.
- 2** Insert the CD-ROM into the CD-ROM drive.
Auto Run will start the installer.
- 3** Select a language for the interface language, and then click **[OK]**.
The following languages are available: Cestina (Czech), Dansk (Danish), Deutsch (German), English (English), Espanol (Spanish), Francais (French), Italiano (Italian), Korean (Korean) Magyar (Hungarian), Nederlands (Dutch), Norsk (Norwegian), Polski (Polish), Portugues (Portuguese), Russian (Russian), Suomi (Finnish), Svenska (Swedish)
The default interface language is English.
- 4** Click **[PCL/RPCS Printer Drivers]**.
The software license agreement appears in the **[License Agreement]** dialog box.
- 5** After reading through the agreement, click **[I accept the agreement]** to agree, and then click **[Next]**.
- 6** Select the printer drivers you want to install when the **[Select Program]** dialog box appears, and then click **[Next]**.
- 7** Select the model of the machine you are using.
To change the printer name, change it in the **[Change settings for 'Printer Name']** box.
- 8** Double-click the machine name to display the printer settings.
- 9** Select SmartNetMonitor.

SmartNetMonitor

- A Click **[Port:]**, and then click **[Add]**.
- B Click **[SmartNetMonitor]**, and then click **[OK]**.
- C Select the machine you want to use.

❖ TCP/IP

- ① Click **[TCP/IP]**, and then click **[Search]**.
Available machines will be listed.
- ② Select the machine you want to use, and then click **[OK]**.

Note

- Machines that respond to an IP broadcast from the computer will be displayed. To print to a machine not listed here, click **[Specify Address]**, and then enter the IP address or host name.
- Under Windows 95/98/Me, avoid using an address that is partially similar to one already in use. For example, if "192.168.0.2" is already used, "192.168.0.2xx" cannot be used. Similarly, if "192.168.0.20" is already used, "192.168.0.2" cannot be used.

❖ NetBEUI

- ① Click **[NetBEUI]**, and then click **[Search]**.
A list of machines that can be used with NetBEUI appears.
- ② Select the machine you want to use, and then click **[OK]**.

 **Note**

- NetBEUI cannot be used under Windows XP.
- Machines that respond to a broadcast from the computer will be displayed. To print to a machine not listed here, click **[Specify Address]**, and then enter the NetBEUI address. Confirm the NetBEUI address on the network is on the configuration page. For more information about printing the configuration page, see "Printer Features Parameters", *Printer Reference 2*. The NetBEUI address appears as "\\RNPxxxx\xxx" on the configuration page. Enter the machine's network path name in the form of "%Computer name\Share name". Do not enter "\\\" but "%%" as head characters.
- You cannot print to machines beyond routers.

❖ **IPP**

- ① Click **[IPP]**.
The IPP setting dialog box appears.
- ② To specify the IP address of the machine, enter "http://machine's-ip-address/printer" or "ipp://machine's-ip-address/printer" in the **[Printer URL]** box.
(Example: IP address is 192.168.15.16)
http://192.168.15.16/printer
ipp://192.168.15.16/printer

- ③ If necessary, enter the names to distinguish the machine in the **[IPP Port Name]** box. Enter a different name to those of any existing port name. If you do not do this, the address entered in the **[Printer URL]** box will be set as the IPP port name.
- ④ If a proxy server and IPP user name are used, click **[Detailed Settings]**, and then configure the necessary settings.

 **Note**

- For more information about these settings, see SmartNetMonitor for Client Help.
- ⑤ Click **[OK]**.

10 Make sure the location for the selected machine appears after **[Port:]**.

11 Configure the user code and default printer as necessary.

❖ **User Code**

User codes are eight digit codes that allow you to keep track of printing done under each code. To use this feature, the network administrator should assign user codes and inform users of them before they install the printer driver. Use the following methods to enter a user code for registration:

- For the PCL 6/5e or PostScript 3 printer drivers, enter the user code on the **[Statistics]** tab in the printer properties dialog box.

- For the RPCS™ printer driver, click the **[Printer Configuration]** button on the **[Print Settings]** tab in the printer properties dialog box. Click the **[User Code]** button. A dialog box appears. Enter the user code in the dialog box.

 **Note**

- When using the RPCS™ printer driver on Windows 95/98/Me, the user code cannot be changed once it is entered. To change an entered user code, uninstall the printer driver, reinstall it, and then enter a new user code.

 **Reference**

For more information about user codes, see “User Codes”, *General Settings Guide*.

 **Default Printer**

Select the **[Default Printer]** check box to set the printer as the default printer.

12 Click **[Continue]** to start printer driver installation.

13 Follow the instructions on the screen.

Changing port settings

Follow these steps to change SmartNetMonitor for Client settings, such as the proxy server settings or IPP URL.

 **Note**

- There are no settings for NetBEUI.

1 In the **[Printers]** window, click the icon of the machine you want to use. On the **[File]** menu, click **[Properties]**.

 **Note**

- Under Windows XP, click the icon of the machine you want to use in the **[Printers and Faxes]** window.

2 Click the **[Details]** tab, and then click **[Port Settings]**.

The **[Port Settings]** dialog box appears.

 **Note**

- Under Windows 2000/XP, Windows NT 4.0 click the **[Ports]** tab, and then click **[Configure Port]**. The **[Port Configuration]** dialog box appears.

- For TCP/IP, you can configure Timeout Settings.

 **Note**

- If you cannot set the items on the **[Recovery/Parallel Printing]** tab, follow the procedure below.

① Click **[Cancel]** to close the **[Port Settings]** dialog box.

② Start SmartNetMonitor for Client, and then right-click the SmartNetMonitor for Client icon on the taskbar.

③ Click **[Extended Features Settings]**, and then select the **[Set Recovery/Parallel Printing for each port]** check box.

④ Click **[OK]** to close the **[Extended Features Settings]** dialog box.

- For IPP, you can configure IPP User Settings, Proxy Settings and Timeout Settings.

 **Note**

- For more information about these settings, see SmartNet-Monitor for Client Help.

2

Setting Up Options - PCL 6/5e and RPCS

If the machine has options installed, you should set the options using the printer driver.

 **Limitation**

- Under Windows 2000/XP, changing printer settings requires Manage Printers permission. Members of the Administrators and Power Users groups have Manage Printers permission by default. When you set up options, log on using an account that has Manage Printers permission.
- Under Windows NT 4.0, changing printer settings requires Full Control permission. Members of the Administrators, Server Operators, Print Operators, and Power Users groups have Full Control permission by default. When you set up options, log on using an account that has Full Control permission.

When setting up options, you should access the printer properties dialog box from Windows. You cannot set up options by accessing the printer properties dialog box from an application.

PCL 6/5e printer driver

- 1** On the [Start] menu, point to [Settings], and then click [Printers].

The [Printers] window appears.

 **Note**

- If using Windows XP Professional, click the [Printers and Faxes] window on the [Start] menu.
- If using Windows XP Home Edition, access the [Printers and Faxes] window by clicking the [Start] button on the taskbar, click [Control Panel], click [Printers and Other Hardware], and then click [Printers and Faxes].

- 2** Click the icon of the machine you want to use.

- 3** On the [File] menu, click [Properties].

The printer properties dialog box appears.

- 4** Click the [Accessories] tab.

- 5** Select the options installed in the [Options] area.

- 6** Click [OK].

RPCS™ printer driver

- 1 On the [Start] menu, point to [Settings], and then click [Printers].

The [Printers] window appears.

 **Note**

- If using Windows XP Professional, click the [Printers and Faxes] window on the [Start] menu.
- If using Windows XP Home Edition, access the [Printers and Faxes] window by clicking the [Start] button on the taskbar, click [Control Panel], click [Printers and Other Hardware], and then click [Printers and Faxes].

- 2 Click the icon of the machine you want to use.

- 3 On the [File] menu, click [Properties].

The printer properties dialog box appears.

 **Note**

- If the following message appears “Configure installed accessories in the [Accessories] tab of [Printer Configuration], which will open next.”, click [OK], and then proceed to step 3.

- 4 Click the [Change Accessories] tab.

 **Note**

- In Windows 95/98/Me, click [Printer Configuration] on the [Print Settings] tab, and then click [Change Accessories].

- 5 Select the options installed in the [Select printer options:] list.

- 6 Click [OK].

- 7 Click [OK], and then close the printer properties dialog box.

Installing the PostScript 3 Printer Driver

This section gives basic instructions for installing the PostScript 3 printer driver. Actual procedures may differ depending on the operating system. Follow the procedures below, as appropriate.

 **Reference**

To use the PostScript 3 printer driver, the optional PostScript 3 board must be installed on the machine. See *PostScript 3 Unit Type 2045 Operating Instructions Supplement* for details.

Windows 95/98/Me - Installing the PostScript 3 printer driver

- 1 Quit all applications running.

- 2 Insert the CD-ROM into the CD-ROM drive.

Auto Run will start the installer.

- 3 Select a language for the interface language, and then click [OK].

The following languages are available: Cestina (Czech), Dansk (Danish), Deutsch (German), English (English), Espanol (Spanish), Francais (French), Italiano (Italian), Korean (Korean) Magyar (Hungarian), Nederlands (Dutch), Norsk (Norwegian), Polski (Polish), Portugues (Portuguese), Russian (Russian), Suomi (Finnish), Svenska (Swedish)

The default interface language is English.

 **Note**

- The printer driver with the selected language will be installed.
- The printer driver will be installed in English if you select the following languages: Cestina, Magyar, Polski, Portugues, Suomi, Korean and Russian.

4 Click **[PostScript 3 Printer Driver]**.

Add Printer Wizard starts.

5 Click **[Next]**.**6** Click **[Local Printer]**, and then click **[Next]**.

A dialog box for selecting the printer appears.

7 Select the model of the machine you are using, and then click **[Next]**.**8** In the **[Available ports:]** box, click **[Printer Port]**, and then click **[Next]**.**9** Change the name of the machine if you want to, and then click **[Next]**. **Note**

- Click **[Yes]** if you want to set the machine as the default printer.

10 Follow the instructions on the screen.

Windows 95/98/Me - Setting up options

If the machine has options installed, you should make settings for them using the printer driver.

1 On the **[Start]** menu, point to **[Settings]**, and then click **[Printers]**.

The **[Printers]** window appears.

2 Click the icon of the machine you want to use.**3** On the **[File]** menu, click **[Properties]**.

The printer properties dialog box appears.

4 Click the **[Accessories]** tab.**5** Select the options you have installed in the **[Options]** area.**6** Click **[OK]**.

Windows 2000/XP - Installing the PostScript 3 printer driver

 **Limitation**

- Installing a printer driver requires Administrator permission. When you install a printer driver, log on using an account that has Administrator permission.

 **Note**

- If you want to share the machine on a Windows 2000/XP platform, use the **[Sharing]** tab in the printer properties dialog box to specify the additional driver (alternate driver). For details, see the operating instructions that come with Windows 2000/XP.
- When prompted for the additional driver (alternate driver) location, select the following folders on the CD-ROM:

- **Windows 95/98/Me:** \DRIVERS\PS\WIN9X_ME\ (Language)\DISK1\
- **Windows NT 4.0:** \DRIVERS\PS\NT4\ (Language)\DISK1\

1 Quit all applications that are running.

- 2** Insert the CD-ROM into the CD-ROM drive.

Auto Run will start the installer.

- 3** Select a language for the interface language, and then click **[OK]**.

The following languages are available: Cestina (Czech), Dansk (Danish), Deutsch (German), English (English), Espanol (Spanish), Francais (French), Italiano (Italian), Korean (Korean) Magyar (Hungarian), Nederlands (Dutch), Norsk (Norwegian), Polski (Polish), Portugues (Portuguese), Russian (Russian), Suomi (Finnish), Svenska (Swedish)

The default interface language is English.

 **Note**

- The printer driver with the selected language will be installed.
- The printer driver will be installed in English if you select the following languages: Cestina, Magyar, Polski, Portugues, Suomi, Korean and Russian.

- 4** Click **[PostScript 3 Printer Driver]**.

Add Printer Wizard starts.

- 5** Click **[Next]**.

- 6** Click **[Local Printer]**, and then click **[Next]**.

 **Note**

- If using Windows XP, click **[Local printer attached to this computer]**, and then click **[Next]**.

A dialog box for selecting the printer port appears.

- 7** Select the check box of the port you want to use, and then click **[Next]**.

A dialog box for selecting the printer appears.

- 8** Select the model of the machine you are using, and then click **[Next]**.

- 9** Change the name of the machine if you want to, and then click **[Next]**.

 **Note**

- Click **[Yes]** if you want to set the machine as the default printer.

- 10** Select whether or not you want to share the machine, and then click **[Next]**.

 **Reference**

See *Network Guide* for information about setting up and using the machine in a network environment.

- 11** Follow the instructions on the screen.

Windows 2000/XP - Setting up options

If the machine has options installed, you should make settings for them using the printer driver.

 **Limitation**

- Changing the printer settings requires Manage Printers permission. Members of the Administrators and Power Users groups have Manage Printers permission by default. When you set up options, log on using an account that has Manage Printers permission.

- 1** On the **[Start]** menu, point to **[Settings]**, and then click **[Printers]**.

The **[Printers]** window appears.

 **Note**

- In Windows XP Professional, click the **[Printers and Faxes]** window on the **[Start]** menu.
- In Windows XP Home Edition, access the **[Printers and Faxes]** window by clicking the **[Start]** button on the taskbar, click **[Control Panel]**, **[Printers and Other Hardware]**, and then click **[Printers and Faxes]**.

- 2** Click the icon of the machine you want to use.

- 3** On the **[File]** menu, click **[Properties]**.

The printer properties dialog box appears.

- 4** Click the **[Device Settings]** tab.

- 5** Select the options you have installed under **[Installable Options]**.

- 6** Click **[OK]**.

Windows NT 4.0 - Installing the PostScript 3 printer driver

 **Limitation**

- Installing a printer driver requires Administrator permission. When you install a printer driver, log on using an account that has Administrator permission.

 **Important**

- The CD-ROM containing Windows NT Server operating system version 4.0, or the Windows NT Workstation operating system is required to install the printer driver.

- We recommend that you upgrade Windows NT 4.0 operating system to Service Pack 6 or later before installing the printer driver. Contact your Windows retailer for more information about latest versions.

 **Note**

- If you want to share the machine on a Windows NT 4.0 platform, use the **[Sharing]** tab in the printer properties dialog box to specify the additional driver (alternate driver). For details, see the operating instructions that come with Windows NT 4.0.

- When prompted for the additional driver (alternate driver) location, select the following folders on the CD-ROM:

- **Windows 95/98/Me:** \DRIVERS\PS\WIN9X_ME\ (Language)\DISK1\

- 1** Quit all applications running.

- 2** Insert the CD-ROM into the CD-ROM drive.

Auto Run will start the installer.

- 3** Select a language for the interface language, and then click **[OK]**.

The following languages are available: Cestina (Czech), Dansk (Danish), Deutsch (German), English (English), Espanol (Spanish), Francais (French), Italiano (Italian), Korean (Korean) Magyar (Hungarian), Nederlands (Dutch), Norsk (Norwegian), Polski (Polish), Portugues (Portuguese), Russian (Russian), Suomi (Finnish), Svenska (Swedish)

The default interface language is English.

 **Note**

- The printer driver with the selected language will be installed.
- The printer driver will be installed in English if you select the following languages: Cestina, Magyar, Polski, Portugues, Suomi, Korean and Russian.

4 Click **[PostScript 3 Printer Driver]**.

Add Printer Wizard starts.

5 Confirm that the **[My Computer]** option is selected, and then click **[Next]**.

A dialog box for selecting the printer port appears.

6 Select the check box of the port you want to use, and then click **[Next]**.

A dialog box for selecting the printer appears.

7 Select the model of the machine you are using, and then click **[Next]**.**8** Change the name of the machine if you want to, and then click **[Next]**. **Note**

- Click **[Yes]** if you want to set the machine as the default printer.

9 Select whether or not you want to share the machine, and then click **[Next]**. **Reference**

See *Network Guide* for information about setting up and using the machine in a network environment.

10 Follow the instructions on the screen.

Windows NT 4.0 - Setting up options

If the machine has options installed, you should make settings for them using the printer driver.

 **Limitation**

- Changing printer settings requires Manage Printers permission. Members of the Administrators and Power Users groups have Manage Printers permission by default. When you set up options, log on using an account that has Manage Printers permission.

1 On the **[Start]** menu, point to **[Settings]**, and then click **[Printers]**.

The **[Printers]** window appears.

2 Click the icon of the machine you want to use.**3** On the **[File]** menu, click **[Properties]**.

The printer properties dialog box appears.

4 Click the **[Device Settings]** tab.**5** Select the options you have installed under **[Installable Options]**.**6** Click **[OK]**.

Bidirectional transmission

When bidirectional transmission is enabled, information such as paper size and feed orientation is automatically sent to the computer. You can also check machine status from your computer.

- Bidirectional transmission is supported under Windows 95/98/Me, Windows 2000/XP, and Windows NT 4.0.
- When bidirectional transmission is running, machine status and information can be viewed by opening the printer driver screen.

To support bidirectional transmission, the following conditions are required:

❖ When connecting with a parallel cable

- The computer must support bidirectional transmission.
- The machine must be set to bidirectional transmission.
- The machine parallel port and computer parallel port must be connected using a parallel interface cable that supports bidirectional transmission.

Note

- In Windows 95/98/Me, **[Enable bi-directional support for this printer]** must be selected in **[Spool Settings]** on the **[Details]** tab in RPCS™ printer driver.
- In Windows 2000/XP, or Windows NT 4.0, **[Enable bidirectional support]** must be selected, and **[Enable printer pooling]** must not be selected on the **[Ports]** tab in RPCS™ printer driver.

❖ When connecting with the network

- The machine must be set to bidirectional transmission.
- SmartNetMonitor for Client included on the CD-ROM must be installed.

One of the following conditions must also be satisfied as well as the two requirements mentioned above:

- The port for SmartNetMonitor and TCP/IP must be used.
- The standard TCP/IP port is used without changing the port name (Windows 2000/XP).
- The IP address specified in the Microsoft TCP/IP Print is used (Windows NT 4.0).
- The IP address is included in port name, if using IPP protocol.

Note

- In Windows 95/98/Me, **[Enable bi-directional support for this printer]** must be selected in **[Spool Settings]** on the **[Details]** tab in RPCS™ printer driver.
- In Windows 2000/XP, or Windows NT 4.0, **[Enable bidirectional support]** must be selected, and **[Enable printer pooling]** must not be selected on the **[Ports]** tab in RPCS™ printer driver.

❖ When connecting with IEEE 1394

- The port on the optional IEEE 1394 interface board and the IEEE 1394 port on the computer are connected using an interface cable (Windows 2000/XP, Windows Me).

Note

- [SCSI print (SBP-2)] must be set to Active and [Bidirectional SCSI print] must be set to ON in [IEEE 1394] on the [Interface Settings] tab in the machine's System Settings.
- In Windows Me, [Enable bi-directional support for this printer] must be selected in [Spool Settings] on the [Details] tab in RPCS™ printer driver.
- In Windows 2000/XP, [Enable bi-directional support] must be selected, and [Enable printer pooling] must not be selected on the [Ports] tab in RPCS™ printer driver.

❖ When connecting with USB 2.0

- The port on the optional USB 2.0 interface board and the USB port on the computer are connected using a USB interface cable (Windows 98 SE/Me, Windows 2000/XP).

Note

- In Windows 98 SE/Me, [Enable bi-directional support for this printer] must be selected in [Spool Settings] on the [Details] tab in RPCS™ printer driver.
- In Windows 2000/XP, [Enable bi-directional support] must be selected, and [Enable printer pooling] must not be selected on the [Ports] tab in RPCS™ printer driver.

Mac OS - Installing the PostScript 3 Printer Driver and Utilities

It is necessary to install a printer driver and a PPD file to print from a Macintosh.

Follow this procedure to install a printer driver and a PPD file on Macintosh running OS 8.6 or later versions up to 9.2, and Mac OS X Classic mode.

Note

- For installation under Mac OS X (v10.1.x), see p.31 "Mac OS X - Installing the PostScript 3 Printer Driver".

- 1** Insert the CD-ROM into the CD-ROM drive.
- 2** Double-click the CD-ROM icon.
- 3** Double-click the [Mac OS 8 and 9] folder.
- 4** Double-click the [PS Driver] folder.
- 5** Double-click the folder of the language you use.
- 6** Open [Disk 1], and then double-click the installer icon.
The PostScript 3 printer driver installer window appears.
- 7** Follow the instructions on the screen.
- 8** Double-click [Extensions] in [System Folder].
- 9** Double-click [Printer Descriptions].
- 10** Double-click the CD-ROM icon on the desktop.



- 1** Double-click the [Printer Descriptions] folder in the [Mac OS 8 and 9] folder.
- 2** Double-click [Disk 1] in the folder of the language you use.
- 3** Drag the PPD file into [Printer Descriptions] in [Extensions] in [System Folder].
- 4** Restart the Macintosh.

Setting up the PPD file

Preparation

Make sure that the machine is connected to an AppleTalk network before performing the following procedure:

- 1** On the Apple menu, click [Chooser].
- 2** Click the [Adobe PS] icon.
- 3** In the [Select a PostScript Printer:] list, click the name of the machine you want to use.
- 4** Click [Setup].
- 5** Click the printer description file you want to use, and then click [Select].

The PPD file is set up, and the [Adobe PS] icon appears at the left of the machine name in the list. Next, follow the procedure on p.30 "Setting up options" to make the option settings, or close the [Chooser] dialog box.

Setting up options

- 1** On the Apple menu, click [Chooser].
- 2** Click the [Adobe PS] icon.

- 3** In the [Select a PostScript Printer:] list, click the name of the machine you want to use, and then click [Setup].

- 4** Click [Configure].

A list of options appears.

- 5** Select the option you want to set up, and then select the appropriate setting for it.

Note

- If the option you want to set up is not displayed, the PPD file might not be set up correctly. Check the name of the PPD file shown in the dialog box.

- 6** Click [OK].

The list of options closes.

- 7** Click [OK].

The [Chooser] dialog box appears.

- 8** Close the [Chooser] dialog box.

Installing Adobe Type Manager (ATM)

Note

- Quit all applications running before installation. Install after restarting.

- 1** Start the Macintosh.

- 2** Insert the CD-ROM into the CD-ROM drive.

- 3** Double-click the CD-ROM icon.

- 4** Double-click the [Mac OS 8 and 9] folder.

- 5** Double-click the [ATM] folder.

- 6** Double-click the [ATM 4.6.2 installer] icon.

7 Follow the instructions on screen.

8 Restart the Macintosh.

 **Note**

- Make sure to restart the computer. **[ATM]** will be completely installed only after restarting.

9 Select **[Control Panel]** from the Apple menu, and then click **[ATM]**.

10 Open the ATM control panel.

 **Note**

- For more information about installation, see the User's Guide in the ATM folder.

Installing screen fonts

1 Start the Macintosh.

2 Insert the CD-ROM into the CD-ROM drive.

3 Double-click the CD-ROM icon.

4 Double-click the **[Mac OS 8 and 9]** folder.

5 Double-click the **[Fonts]** folder.

6 Copy the fonts you want to install into the **[System]** folder.

A confirmation dialog box appears.

7 Click **[OK]**.

The fonts are installed.

8 Restart the Macintosh.

 **Reference**

For information about installing Printer Utility for Mac, see *PostScript 3 Unit Type 2045 Operating Instructions Supplement*.

Mac OS X - Installing the PostScript 3 Printer Driver

It is necessary to install a PPD file to print from a Macintosh. Follow the procedures to install a PPD file on Macintosh running Mac OS X.

Printer driver is included in Mac OS. When printing under Mac OS X v10.1.x, use the printer driver included in Mac OS.

 **Preparation**

You need an administrator name and a password (phrase). For more information, consult your administrator.

1 Insert the CD-ROM into the CD-ROM drive.

2 Double-click the CD-ROM icon.

3 Double-click the **[Mac OS X]** folder.

4 Double-click the **[PPD Installer]** folder, and then double-click the installer icon.

5 Follow the instructions on screen.

Setting up the PPD file

1 Run Print Center.

2 Click **[Add Printer]**.

 **Note**

- Select **[AppleTalk]** in the first pop-up menu.
- If the zone has been set, select the zone in the second pop-up menu.

3 Select the PPD file for the model you are using from the **[Printer Model:]** pop-up menu.

4 Click **[Add]**.

Setting up options

 **Limitation**

- You can make settings for all printer features, even if the necessary option is not installed, due to Mac OS X Native mode limitations. Check which options are installed in the machine before you print.

Installing the Printer Driver Using USB

This section gives basic instructions for installing printer drivers using USB. The printer drivers can be installed from the CD-ROM that comes with this machine.

 **Preparation**

Make sure that all other applications are closed and the computer is not printing before installation.

Windows 98 SE/Me - Installing the printer driver using USB

The procedure below uses Windows 98 as an example. The procedure for Windows Me may be slightly different.

When the USB interface cable is used for the first time, the “plug and play” function starts and **[New Hardware Found]** dialog box appears.

If printer drivers are already installed, “plug and play” appears, and the printer with its port directed to the USB interface cable is added to the **[Printers]** folder.

1 Click **[Next]**.**2** Click **[Search for the best driver for your device. {Recommended}.]**, and then click **[Next]**.**3** Select the **[Specify a location:]** check box, and then click **[Browse...]**.

The **[Browse for Folder]** dialog box appears.

4 Insert the CD-ROM provided into the CD-ROM drive. **Note**

- When Auto Run starts, click **[Exit]**.
- If you want to disable Auto Run, press **[Shift]** when inserting the CD-ROM into the drive and keep it pressed until the computer completes transmission to the drive.

5 Select the drive where the printer driver is located according to your operating system, and then click **[Next]**.

If the CD-ROM drive is D, the folder will be “D:\DRIVERS\USB-PRINT\WIN98ME”.

6 Confirm the printer driver location, and then click **[Next]**.

USB Printing Support will be installed.

7 Click **[Finish]**.

8 Follow the “plug and play” on the screen to install the printer drivers.

 **Note**

- Each printer driver is stored in the following folders on the CD-ROM:
 - **PCL 6:** \DRIVERS\PCL6\WIN9X_ME\Language\DISK1
 - **PCL 5e:** \DRIVERS\PCL5E\WIN9X_ME\Language\DISK1
 - **RPCS™:** \DRIVERS\RPCS\WIN9X_ME\Language\DISK1
 - **PostScript 3:** \DRIVERS\PS\WIN9X_ME\Language\DISK1

When installation is complete, the printer with its port directed to “USB00n” appears in the **[Printers]** folder. (“n” is the number of printers connected.)

Windows 2000/XP - Installing the printer driver using USB

 **Limitation**

- Installing a printer driver requires the Administrators permission. When you install a printer driver, log on using an account that has Administrator permission.

When the USB interface cable is used for the first time, the **[Found New Hardware Wizard]** dialog box appears, and Windows 2000/XP's USB Printing Support will be installed automatically.

If the printer driver is already installed, the “plug and play” is displayed, and the printer with its port directed to the USB interface cable is added to the **[Printers]**^{*1} folder.

 **Note**

- Under Windows XP, even if the printer driver has already been installed, **[Found New Hardware Wizard]** may start when connecting the printer and the computer with the USB interface cable for the first time. If this happens, install the printer driver by following the procedure below:

1 Install the printer driver by referring to the instructions for installation.

 **Note**

- Each printer driver is stored in the following folders on the CD-ROM:
 - **PCL 6:** \DRIVERS\PCL6\WIN2K_XP\Language\DISK1
 - **PCL 5e:** \DRIVERS\PCL5E\WIN2K_XP\Language\DISK1
 - **RPCS™:** \DRIVERS\RPCS\WIN2K_XP\Language\DISK1
 - **PostScript 3:** \DRIVERS\PS\WIN2K_XP\Language\DISK1

When installation is complete, the printer with its port directed to “USB00n” appears in the **[Printers]**^{*1} folder. (“n” is the number of printers connected.)

^{*1} In Windows XP, the folder is **[Printers and Faxes]**.

Macintosh - Creating a desktop printer icon

When you connect the machine and your computer using USB 2.0, create a Desktop Printer icon.

Limitation

- In Mac OS X Native mode, printing is disabled when connected to the machine using USB.

1 Double-click **[Desktop Printer Utility]** in the **[AdobePS Components]** folder.

2 Select **[AdobePS]** in **[With:]** and **[Printer (USB)]** in **[Create Desktop]**, and then click **[OK]**.

3 Click **[Change]** in **[USB Printer Selection]**.

4 Select the model of the machine you are using in **[Select a USB Printer:]**, and then click **[OK]**.

5 Click **[Auto Setup]** in **[PostScript™ Printer Description (PPD) File]**.

6 Click **[Create]**.

7 Enter the machine name, and then click **[Save]**.

The printer icon appears on the desktop.

8 Close the Desktop Printer Utility.

Installing the Printer Driver Using IEEE 1394

Printing using a SCSI print device with the optional IEEE 1394 interface unit is possible under Windows 2000, or Windows XP.

Preparation

Make sure that all other applications are closed and the computer is not printing before installation.

Important

- When the printer driver is being installed, do not turn on the power of other printers connected to the same bus, or connect another IEEE 1394 device.
- Before uninstalling the printer driver, be sure to disconnect the IEEE 1394 interface cable from the computer.
- SCSI print must be enabled using the display panel. See "Interface Settings/IEEE 1394", *Network Guide*.
- SCSI print using the optional IEEE 1394 interface board is not supported by Windows 95/98/Me, or Windows NT 4.0. If the "plug and play" function starts, click **[Cancel]** in the **[New Hardware Found]** or **[Device Driver Wizard]** dialog box.

Note

- If **[Found New Hardware Wizard]** appears every time the computer is started or the cable is connected with Windows 2000 or Windows XP when the printer function that uses SCSI print is not installed, disable the device. See p.36 "Disabling the Device" for more information.

- ❑ If you send data from your computer when data is being received from another client computer, your data will be printed after completing the print job for the other client computer.
- ❑ When the machine is connected to the computer properly via the 1394 interface, the appearance of the icon in the printer window changes.

Windows 2000

Important

- ❑ In Windows 2000, the optional IEEE 1394 interface board can only be used with Service Pack 1 or later. If the Service Pack is not installed, the connectable number of devices in an IEEE 1394 bus is only one, and the client cannot access the IEEE 1394 interface board without using an account that has Administrator permission.

1 Connect the machine and computer using the IEEE 1394 interface cable.

The **[Found New Hardware Wizard]** dialog box appears.

2 Click **[Next]**.

“This wizard will complete the installation for this Device: Unknown” appears.

3 Select **[Optional search locations:]**, and then click **[Next]**.

4 When “Locate Driver Files” appears, select the **[Optional search locations.]** check box and the **[Specify a location]** check box, and then click **[Next]**.

5 Hold down the left **[SHIFT]** key and insert the CD-ROM into the CD-ROM drive.

Keep the left **[SHIFT]** key held down until the computer has finished accessing the CD-ROM.

If the Auto Run program starts, click **[Cancel]**, and then click **[Exit]**.

6 Click **[Browse]**.

7 Select the printer driver you want to install. Each printer driver is stored in the following folders:

- **PCL 6:** \DRIVERS\PCL6\WIN2K_XP\ (Language)\DISK1
- **PCL 5e:** \DRIVERS\PCL5E\WIN2K_XP\ (Language)\DISK1
- **RPCS™:** \DRIVERS\RPCS\WIN2K_XP\ (Language)\DISK1
- **PostScript 3:** \DRIVERS\PS\WIN2K_XP\ (Language)\DISK1

8 Click **[Open]**.

9 Click **[OK]**.

A printer model selection dialog box appears.

10 Follow the instructions on the screen.

Note

- ❑ When installation is complete, the printer with its port directed to “1394_00n” appears in the **[Printers]** folder. (“n” is the number of printers connected.)

Windows XP

1 Connect the machine and the computer using the IEEE 1394 interface cable.

The **[Found New Hardware Wizard]** dialog box appears.

- ❑ 2 Confirm that “This wizard helps you install software for: (printer name)” is displayed, and click **[Install from a list or specific location (Advanced)]**, and then click **[Next]**.

“Please choose your search and installation option.” appears.

- ❑ 3 Select the **[Search for the best driver in these locations.]** check box, and **[Include this location in the search:]** check box.

- ❑ 4 Install the printer driver following the same procedure as in steps ❸ to ❹ for Windows 2000.

 **Note**

- ❑ When installation is complete, a printer with its port directed to “1394_00n” appears in the **[Printers and Faxes]** folder. (“n” is the number of printers connected.)

 **Disabling the Device**

- ❖ If **[Add New Hardware Wizard]** appears every time you restart the computer using an operating system that does not support SCSI print, or plug in/take out the cable, disable the device with the following procedure:

- Windows Me
 - ❶ In the **[Add New Hardware Wizard]** dialog box, confirm that **[Windows has found the following new Hardware: IEEE SBP-2 Device]** is displayed, and click **[Recommended search for a better driver [Recommended]]**, and then click **[Next]**.
 - ❷ When “Windows was unable to locate the software for this device.” appears, click **[Finish]**.

- ❖ If you do not want to install the printer when **[Found New Hardware Wizard]** starts when using an operating system that supports SCSI print, disable the device with the following procedure:

- Windows 2000
 - ❶ In the **[Found New Hardware Wizard]** dialog box, click **[Next]**.
 - ❷ When “This wizard will complete the installation for this Device: Unknown” appears, click **[Search for a suitable driver for my device [recommended]]**, and then click **[Next]**.
 - ❸ When “Locate Driver Files” appears, remove all selections from **[Optional search locations.]**, and then click **[Next]**.
 - ❹ When “Driver Files Search Results” appears, click **[Disable the device. The Add/Remove Hardware Wizard in the control panel can be used to complete the driver installations.]**, and then click **[Finish]**.
- Windows XP
 - ❶ In the **[Found New Hardware Wizard]** dialog box, confirm “This wizard helps you install software for: Unknown” is displayed, and click **[Install from a list on specific location (Advanced)]**, and then click **[Next]**.
 - ❷ When “Please choose your search and installation option.” appears, remove all selections from **[Search for the best driver in these locations.]**, and then click **[Next]**.

- ③ When “The wizard could not find the software on your computer for..” appears, click **[OK]**.
 - ④ When “Cannot Install this Hardware” appears, select the **[Don't prompt again to install the software]** check box, and then click **[Finish]**.
- ❖ If **[Found New Hardware Wizard]** appears every time you restart the computer when using an operating system that does not support IP over 1394, or plug in/take out the cable, disable the device with the following procedure:
- Windows 2000
 - ① In **[Found New Hardware Wizard]** dialog box, click **[Next]**.
 - ② When “This wizard will complete the installation for this Device:” and “IP over 1394” appear, click **[Search for a suitable driver for my device [recommended]]**, and then click **[Next]**.
 - ③ When “Locate Driver Files” appears, remove all selections from **[Optional search locations.]**, and then click **[Next]**.
 - ④ When “Driver Files Search Results” appears, click **[Disable the device. The Add/Remove Hardware Wizard in the Control Panel can be used to complete the driver installations.]**, and then click **[Finish]**.
-

Installing SmartNetMonitor for Client/Admin

📍 Limitation

- ❑ If your operating system is Windows 2000/XP or Windows NT 4.0, installing software using Auto Run requires Administrator permission. When you install a printer driver using Auto Run, log on using an account that has Administrator permission.

1 Quit all applications running.

2 Insert the CD-ROM into the CD-ROM drive.

Auto Run will start the installer.

3 Select a language for the interface language, and then click **[OK]**.

The following languages are available: Cestina (Czech), Dansk (Danish), Deutsch (German), English (English), Espanol (Spanish), Francais (French), Italiano (Italian), Korean (Korean) Magyar (Hungarian), Nederlands (Dutch), Norsk (Norwegian), Polski (Polish), Portugues (Portuguese), Russian (Russian), Suomi (Finnish), Svenska (Swedish)

The default interface language is English.

4 Click **[SmartNetMonitor for Client/Admin]**.

The software license agreement appears in the **[License Agreement]** dialog box.

5 After reading through the agreement, click **[I accept the agreement]** to agree, and then click **[Next]**.

6 Select the program you want to install when the **[Select Program]** dialog box appears.

- 7** Follow the instructions on the screen.

Installing Font Manager 2000

Limitation

- If your operating system is Windows 2000/XP or Windows NT 4.0, installing software using Auto Run requires Administrator permission. When you install a printer driver using Auto Run, log on using an account that has Administrator permission.

Note

- Font Manager 2000 English version is provided.

1 Quit all applications running.

2 Insert the CD-ROM into the CD-ROM drive.

Auto Run will start the installer.

3 Select a language for the interface language, and then click **[OK]**.

The following languages are available: Cestina (Czech), Dansk (Danish), Deutsch (German), English (English), Espanol (Spanish), Francais (French), Italiano (Italian), Korean (Korean) Magyar (Hungarian), Nederlands (Dutch), Norsk (Norwegian), Polski (Polish), Portugues (Portuguese), Russian (Russian), Suomi (Finnish), Svenska (Swedish)

The default interface language is English.

4 Click **[Font Manager 2000]**.

5 Follow the instructions on the screen.

Using Adobe PageMaker Version 6.0, 6.5, or 7.0

If you use the machine under Windows 95/98/Me, Windows 2000/XP, or Windows NT 4.0 with Adobe PageMaker, you need to copy the PPD file to the PageMaker folder.

The PPD file is the file with the extension “.ppd” in the folder “DRIVERS\PS\WIN9X_ME\ (Language)\DISK1\” on the CD-ROM.

The **[WIN9X_ME]** folder, inside the **[PS]** folder is for Windows 95/98/Me. Use the folder at a level appropriate for the operating system you are currently using.

The third folder, “(Language)” may be renamed with an appropriate language name.

Copy the file with extension “.ppd” to the PageMaker folder.

- **For PageMaker 6.0 default installation**

The directory is “C:\PM6\RSRC\PPD4”.

- **For PageMaker 6.5 default installation**

The directory is “C:\PM65\RSRC\USENGLISH\PPD4”.

“USENGLISH” may vary depending on your language selection.

- **For PageMaker 7.0 default installation**

The directory is “C:\PM7\RSRC\USENGLISH\PPD4”.

“USENGLISH” may vary depending on your language selection.

 **Note**

- ❑ When using PageMaker, optional features that can be selected by the printer driver will not be active. The following procedure describes how to activate the optional printer features.
 - ① On the **[File]** menu, click **[Print]**. The **[Print Document]** dialog box appears.
 - ② Make the necessary settings in the **[Features]** box.

Software and Utilities Included on the CD-ROM

There are two CD-ROMs that come with the printer option of this machine.

❖ **The Printer/Scanner Unit Type 2045e package contains the following CD-ROMs:**

- Printer Drivers and Utilities
- Operating Instructions for Printer/Scanner

The CD-ROM labeled “Printer Drivers and Utilities” is mainly used for machine printer functions. In this manual, “CD-ROM” refers to the “Printer Drivers and Utilities” CD-ROM, unless specified otherwise.

Printer Drivers

Printing requires installation of a printer driver for your operating system. The following drivers are included on the CD-ROM labeled “Printer Drivers and Utilities” that comes with the printer option of this machine.

Printer Language	PCL 6	PCL 5e	RP CS™	Post Script 3
Windows 95 *1	√	√	√	√ *11
Windows 98 *2	√	√	√	√ *11
Windows Me *3	√	√	√	√ *11
Windows 2000 *4	√	√	√	√ *12
Windows XP *5	√	√	√	√ *12
Windows NT 4.0 *6	√ *9	√ *9	√ *9	√ *10 *11
Mac OS *7				√ *11
Mac OS X *8				√ *13

- *1 Microsoft Windows 95 operating system
- *2 Microsoft Windows 98 operating system
- *3 Microsoft Windows Millennium Edition
- *4 Microsoft Windows 2000 Advanced Server
Microsoft Windows 2000 Server
Microsoft Windows 2000 Professional
- *5 Microsoft Windows XP Professional
Microsoft Windows XP Home Edition
- *6 Microsoft Windows NT Server operating system version 4.0, Microsoft Windows NT Workstation operating system version 4.0 in a computer using x86 processors.
- *7 Versions 8.6 to 9.2 of the Mac OS (Mac OS X Classic mode is supported.)
- *8 Mac OS X 10.1 or later (Native mode)
- *9 Requires Service Pack 4 or later.
- *10 Requires Service Pack 6 or later.
- *11 The Adobe PostScript 3 printer drivers and PostScript Printer Description (PPD) files are included on the CD-ROM labeled “Printer Drivers and Utilities”.
- *12 The PostScript Printer Description (PPD) files are included on the CD-ROM labeled “Printer Drivers and Utilities”.
- *13 The Adobe PostScript Printer Description (PPD) installer is included on the CD-ROM labeled “Printer Drivers and Utilities”.

❖ **PCL printer drivers**

Two kinds of PCL printer drivers: PCL 6 and PCL 5e, are included on the CD-ROM that comes with this machine. These drivers allow the computer to communicate with the machine via a printer language. We recommend PCL 6 as your first choice.

✎ **Note**

- ❑ Some applications may require installation of the PCL 5e printer driver. In this case, you can install PCL 5e without having to install PCL 6.

See p.18 “Installing the PCL 6/5e and RPCS™ Printer Driver”

❖ **RPCS™ printer driver**

The RPCS™ printer drivers are included on the CD-ROM that comes with this machine. This printer driver allows the computer to communicate with the machine via a printer language. The preset type user interface is provided in addition to the usual one.

See p.18 “Installing the PCL 6/5e and RPCS™ Printer Driver” .

❖ **Adobe PostScript 3 printer drivers and PPD files**

The Adobe PostScript 3 printer drivers and the PPD files are included on the CD-ROM that comes with this machine. This printer driver allows the computer to communicate with the printer via a printer language. The PPD files allow the printer driver to enable printer specific functions.

See p.23 “Installing the PostScript 3 Printer Driver” .

❖ **LAN-Fax driver**

The LAN-Fax driver is included on the CD-ROM that comes with this machine. This driver allows you to use LAN-Fax functions. The LAN-Fax driver, Address Book, and LAN-Fax Cover Sheet Editor can be installed using this driver.

Software and Utilities

❖ **SmartNetMonitor for Admin**

This utility is for the system administrator to manage network printers.

🔍 **Reference**

See SmartNetMonitor for Admin online Help for more information about using SmartNetMonitor for Admin.

❖ **SmartNetMonitor for Client**

This utility is for users to manage their own print status on the network.

🔍 **Reference**

See SmartNetMonitor for Client online Help for more information about using SmartNetMonitor for Client.

❖ **Font Manager 2000**

This utility helps you install new screen fonts, or organize and manage fonts already installed on the system.

❖ **1394 Utility**

This utility is for the IEEE 1394 interface board. For more information, see the Readme file or the manual that comes with the optional IEEE 1394 interface board.

❖ USB Printing Support

This utility is for the USB 2.0 interface board. Install this to use USB on computers running Windows 98 SE/Me. For information about installation, see p.32 “Installing the Printer Driver Using USB”.

❖ Acrobat Reader

This utility allows you to read PDF files (Portable Document Format).

 Note

- Documentation about using the machine is included on the CD-ROM in PDF format. See Acrobat Reader online Help for more information about using Acrobat Reader.

❖ Printer Utility for Mac

This utility allows users to download and manage a variety of fonts as well as manage printers. For more information about this utility, see *PostScript 3 Unit Type 2045 Operating Instructions Supplement* which is provided as a PDF file on the CD-ROM labeled “Operating Instructions for Printer/Scanner”.

 Important

- Software and utilities must be uninstalled before installing newer versions of Windows. Reinstall software and utilities after upgrading Windows.

INDEX

1394 Utility, 41

A

Acrobat Reader, 42
ATM
 Macintosh, installing, 30

B

Bidirectional transmission, 28
Bypass tray, 12

C

CD-ROM, 40
Clear/Stop key, 6
Connection
 Ethernet board connection, 10
 IEEE 1394 interface board connection, 10
 Parallel interface connection, 10
 USB connection, 10
Control Panel, 5
Custom size paper, 14
 printing, bypass tray, 12

D

Display panel, 5, 6

E

Energy Saver key, 5

F

Font Manager 2000, 41
 installing, 38
Function keys, 6
Function status indicator, 6

I

IEEE 1394 connection
 installing, printer driver, 34
IP over 1394, 34

M

Macintosh
 ATM, installing, 30
 Screen fonts, installing, 31
Mac OS
 PostScript 3, installing, 29
Mac OS X
 PostScript 3, installing, 31
Main power indicator, 5
 ⇨ *Data In indicator*, 5

N

Number keys, 6

O

OHP Transparencies
 printing, bypass tray, 14
On indicator, 5
Operation switch, 6

P

PageMaker, 38
PCL, 41
PCL 5e
 Windows 2000/XP, installing, 18
 Windows 95/98/Me, installing, 18
 Windows NT 4.0, installing, 18
PCL 6
 Windows 2000/XP, installing, 18
 Windows 95/98/Me, installing, 18
 Windows NT 4.0, installing, 18
PostScript 3, 41
 Mac OS, installing, 29
 Mac OS X, installing, 31
 Windows 2000/XP, installing, 24
 Windows 95/98/Me, installing, 23
 Windows NT 4.0, installing, 26
Printer driver
 Auto Run, 15
 installing, IEEE 1394 connection, 34
 installing, USB connection, 32
 PCL 5e, 40
 PCL 6, 40
 PostScript 3, 40
 Quick Install, 16
 RPCS, 40
Printer Utility for Mac, 42

Q

Quick Install, 16

R

RPCS, 41

Windows 2000/XP, installing, 18

Windows 95/98/Me, installing, 18

Windows NT 4.0, installing, 18

S

Screen fonts

Macintosh, installing, 31

SCSI print, 34

SmartNetMonitor for Admin, 37, 41

SmartNetMonitor for Client, 37, 41

Software

Quick Install, 16

T

Thick Paper

printing, bypass tray, 14

U

USB connection

printer driver, installing, 32

USB Printing Support, 42

User Tools/Counter, 5

W

Windows 2000/XP

PCL 5e, installing, 18

PCL 6, installing, 18

PostScript 3, installing, 24

RPCS, installing, 18

Windows 95/98/Me

PCL 5e, installing, 18

PCL 6, installing, 18

PostScript 3, installing, 23

RPCS, installing, 18

Windows NT 4.0

PCL 5e, installing, 18

PCL 6, installing, 18

PostScript 3, installing, 26

RPCS, installing, 18

MEMO



Printer/Scanner Unit Type 2045e



Operating Instructions Printer Reference 2



-
- 1** Setting Up the Printer Driver and Canceling a Print Job
 - 2** Using the Document Server
 - 3** Sample Print/Locked Print
 - 4** Troubleshooting
 - 5** Printer Features
 - 6** Appendix

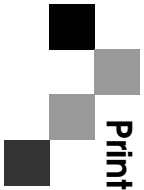

Printer/Scanner Unit Type 2045e Operating Instructions Printer Reference 2

Introduction

This manual describes detailed instructions on the operation and notes about the use of this machine. To get maximum versatility from this machine all operators are requested to read this manual carefully and follow the instructions. Please keep this manual in a handy place near the machine.

Important

Contents of this manual are subject to change without prior notice. In no event will the company be liable for direct, indirect, special, incidental, or consequential damages as a result of handling or operating the machine.

Warning:

Use of controls or adjustment or performance of procedures other than those specified in this manual might result in hazardous radiation exposure.

Trademarks

Microsoft®, Windows® and Windows NT® are registered trademarks of Microsoft Corporation in the United States and/or other countries.

Adobe®, PostScript®, Acrobat® are registered trademarks of Adobe Systems Incorporated.

PCL® is a registered trademark of Hewlett-Packard Company.

AppleTalk, Apple, Macintosh and Mac are registered trademarks of Apple Computer, Incorporated.

IPS-PRINT™ Printer Language Emulation Copyright©2000, Oak Technology, Inc., All Rights Reserved.

UNIX is a registered trademark in the United States and other countries, licensed exclusively through X/Open Company Limited.

Bluetooth is a Trademark of the Bluetooth SIG, Inc. (Special Interest Group) and licensed to RICOH company limited.

Copyright © 2001 Bluetooth SIG, Inc.

The Bluetooth Trademarks are owned by Bluetooth SIG, Inc. USA

Other product names used herein are for identification purposes only and might be trademarks of their respective companies. We disclaim any and all right in those marks.

The proper names of the Windows operating systems are as follows:

- The product name of Windows® 95 is Microsoft®Windows® 95
- The product name of Windows® 98 is Microsoft®Windows® 98
- The product name of Windows® Me is Microsoft®Windows®Millennium Edition (Windows Me)
- The product names of Windows® 2000 are as follows:
Microsoft® Windows® 2000 Advanced Server
Microsoft® Windows® 2000 Server
Microsoft® Windows® 2000 Professional
- The product names of Windows® XP are as follows:
Microsoft®Windows® XP Professional
Microsoft®Windows® XP Home Edition
- The product names of Windows Server™ 2003 are as follows:
Microsoft® Windows Server™ 2003 Standard Edition
Microsoft® Windows Server™ 2003 Enterprise Edition
Microsoft® Windows Server™ 2003 Web Edition
- The product names of Windows® NT are as follows:
Microsoft® Windows NT® Server 4.0
Microsoft® Windows NT® Workstation 4.0
Microsoft® Windows NT® Workstation operating system Version 4.0

Notes:

Some illustrations in this manual might be slightly different from the machine.

Certain options might not be available in some countries. For details, please contact your local dealer.

TABLE OF CONTENTS

Manuals for This Machine	1
How to Read This Manual	3

1. Setting Up the Printer Driver and Canceling a Print Job

Accessing Printer Properties	5
Windows 95/98/Me - Accessing Printer Properties	5
Windows 2000/XP - Accessing Printer Properties	6
Windows NT 4.0 - Accessing Printer Properties	7
Macintosh - Setting Up for Printing	9
Canceling a Print Job	10
Windows - Canceling a Print Job	10
Macintosh - Canceling a Print Job	11

2. Using the Document Server

Accessing the Document Server	13
--	-----------

3. Sample Print/Locked Print

Sample Print	15
Printing a Sample Print File.....	15
Deleting a Sample Print File.....	17
Checking the Error Log	17
Locked Print	18
Printing a Locked Print File	18
Deleting Locked Print Files	19
Checking the Error Log	20
Form Feed	21
Print Using a Selected Tray	21
Canceling Form Feed.....	22

4. Troubleshooting

Error & Status Messages on the Display Panel	23
The Machine Does Not Print	28
Other Printing Problems	31

5. Printer Features

Printer Features Menu	35
Adjusting Printer Features	37
Printer Features Parameters	38
Paper Input	38
List/Test Print	38
Maintenance	41
System	42
Host Interface	44
PCL Menu	45
PS Menu	46

6. Appendix

Finisher	47
Staple	48
Staple Position	48
Stapling Precautions	50
Punch	52
Punch Position	52
Punching Precautions	53
Collate	54
Spool Printing	56
Covers	58
Slip Sheets	60
Chaptering	62
User Defined Pages	64
System Settings (Parallel Connection)	65
Specifications	66
Options	67
INDEX	70

Manuals for This Machine

The following manuals describe the operational procedures of this machine. For particular functions, see the relevant parts of the manual.

Note

- Manuals provided are specific to machine type.
- Adobe Acrobat Reader is necessary to view the manuals as a PDF file.
- Two CD-ROMs are provided:
 - CD-ROM 1“Operating Instructions for Printer/Scanner”
 - CD-ROM 2“Scanner Driver & Document Management Utilities”

❖ **General Settings Guide**

Provides an overview of the machine.

It also describes System Settings (such as paper trays and user codes settings), Document Server functions, and troubleshooting.

❖ **Network Guide (PDF file - CD-ROM1)**

Describes procedures for configuring the machine and computers in a network environment.

❖ **Copy Reference**

Describes operations, functions, and troubleshooting for the machine’s copier function.

❖ **Facsimile Reference <Basic Features>**

Describes operations, functions, and troubleshooting for the machine’s facsimile function.

❖ **Facsimile Reference<Advanced Features>**

Describes advanced functions and settings for key operators.

❖ **Printer Reference 1**

Describes system settings and operations for the machine’s printer function.

❖ **Printer Reference 2 (PDF file - CD-ROM1) (this manual)**

Describes operations, functions, and troubleshooting for the machine’s printer function.

❖ **Scanner Reference (PDF file - CD-ROM1)**

Describes operations, functions, and troubleshooting for the machine’s scanner function.

❖ **Manuals for DeskTopBinder V2 Lite**

DeskTopBinder V2 Lite is a utility included on the CD-ROM labeled “Scanner Driver & Document Management Utilities”.

- DeskTopBinder V2 Lite Setup Guide (PDF file - CD-ROM2)
Describes installation of, and the operating environment for DeskTopBinder V2 Lite in detail. This guide can be displayed from the **[Setup]** dialog box when DeskTopBinder V2 Lite is installed.
- DeskTopBinder V2 Lite Introduction Guide (PDF file - CD-ROM2)
Describes operations of DeskTopBinder V2 Lite and provides an overview of its functions. This guide is added to the **[Start]** menu when DeskTopBinder V2 Lite is installed.
- Auto Document Link Guide (PDF file - CD-ROM2)
Describes operations and functions of Auto Document Link installed with DeskTopBinder V2 Lite. This guide is added to the **[Start]** menu when DeskTopBinder V2 Lite is installed.

❖ **Manuals for ScanRouter V2 Lite**

ScanRouter V2 Lite is a utility included on the CD-ROM labeled “Scanner Driver & Document Management Utilities”.

- ScanRouter V2 Lite Setup Guide (PDF file - CD-ROM2)
Describes installation of, settings, and the operating environment for ScanRouter V2 Lite in detail. This guide can be displayed from the **[Setup]** dialog box when ScanRouter V2 Lite is installed.
- ScanRouter V2 Lite Management Guide (PDF file - CD-ROM2)
Describes delivery server management and operations, and provides an overview of ScanRouter V2 Lite functions. This guide is added to the **[Start]** menu when ScanRouter V2 Lite is installed.

❖ **Other manuals**

- PS3 Supplement (PDF file - CD-ROM1)
- UNIX Supplement (available from an authorized dealer, or as a PDF file on our Web site)

How to Read This Manual

Symbols

In this manual, the following symbols are used:

 **WARNING:**

This symbol indicates a potentially hazardous situation which, if instructions are not followed, could result in death or serious injury.

 **CAUTION:**

This symbol indicates a potentially hazardous situation which, if instructions are not followed, may result in minor or moderate injury, or damage to property.

* The statements above are notes for your safety.

 **Important**

If this instruction is not followed, paper might misfeed, originals might be damaged, or data might be lost. Be sure to read this.

 **Preparation**

This symbol indicates prior knowledge or preparation is required before operation.

 **Note**

This symbol indicates precautions for operation, or actions to take after mal-operation.

 **Limitation**

This symbol indicates numerical limits, functions that cannot be used together, or conditions in which a particular function cannot be used.

 **Reference**

This symbol indicates a reference.

[]

Keys and buttons that appear on the computer's display.

Keys that appear on the machine's display panel.

[]

Keys built into the machine's control panel.

Keys on the computer's keyboard.

1. Setting Up the Printer Driver and Canceling a Print Job

Accessing Printer Properties

Windows 95/98/Me - Accessing Printer Properties

Changing default settings

- 1** On the **[Start]** menu, point to **[Settings]**, and then click **[Printers]**.

The **[Printers]** window appears.

- 2** Click the icon of the machine whose default you want to change.

- 3** On the **[File]** menu, click **[Properties]**.

The printer properties dialog box appears.

- 4** Make the settings you require, and then click **[OK]**.

 **Note**

- With some applications, printer driver settings are not used, and the application's own settings are applied.

Making settings from an application

To make settings for a specific application, open the printer properties dialog box from that application. The following example describes how to make settings for the WordPad application that comes with Windows 95/98/Me.

 **Note**

- Actual procedures for opening the printer properties dialog box may vary depending on the application. For more information, see the operating instructions that come with the application you are using.
- Any setting you make in the following procedure is valid for the current application only:

- 1** On the **[File]** menu, click **[Print]**.

The **[Print]** dialog box appears.

- 2** In the **[Name]** list, select the machine you want to use, and then click **[Properties]**.

The printer properties dialog box appears.

- 3** Make the settings you require, and then click **[OK]**.

- 4** Click **[OK]** to start printing.

Windows 2000/XP - Accessing Printer Properties

Changing default settings - Printer properties

 **Limitation**

- Changing machine settings requires Manage Printers permission. Members of Administrators and Power Users groups have Manage Printers permission by default. When you set up options, log on using an account that has Manage Printers permission.

1 On the [Start] menu, point to [Settings], and then click [Printers].

The [Printers] window appears.

 **Note**

- In Windows XP Professional, open the [Printers and Faxes] window on the [Start] menu.
- In Windows XP Home Edition, open the [Printers and Faxes] window by clicking [Control Panel] from the [Start] button on the taskbar, click [Printers and Other Hardware], and then click [Printers and Faxes].

2 Click the icon of the machine whose default you want to change.

3 On the [File] menu, click [Properties].

The printer properties dialog box appears.

4 Make the settings you require, and then click [OK].

 **Note**

- Normally you do not have to change the “Form to Tray Assignment” settings on the [Device Settings] tab in the PostScript 3 printer driver.
- Settings you make here are used as default for all applications.

Changing default settings - Printing preferences properties

 **Limitation**

- Changing machine settings requires Manage Printers permission. Members of the Administrators and Power Users groups have Manage Printers permission by default. When you set up options, log on using an account that has Manage Printers permission.

1 On the [Start] menu, point to [Settings], and then click [Printers].

The [Printers] window appears.

 **Note**

- In Windows XP Professional, open the [Printers and Faxes] window on the [Start] menu.
- In Windows XP Home Edition, open the [Printers and Faxes] window by clicking [Control Panel] from the [Start] button on the taskbar, click [Printers and Other Hardware], and then click [Printers and Faxes].

2 Click the icon of the machine whose default you want to change.

- 3** On the **[File]** menu, click **[Printing Preferences...]**.

The **[Printing Preferences]** dialog box appears.

- 4** Make the settings you require, and then click **[OK]**.

 **Note**

- Settings you make here are used as default for all applications.

Making settings from an application

To make settings for a specific application, open the **[Print]** dialog box from that application. The following example describes how to make settings for the WordPad application that comes with Windows 2000/XP.

 **Note**

- Actual procedures for opening the **[Print]** dialog box vary depending on the application. For more information, see the operating instructions that come with the application you are using.
- Any setting you make in the following procedure is valid for the current application only.

- 1** On the **[File]** menu, click **[Print...]**.

The **[Print]** dialog box appears.

- 2** In the **[Select Printer]** list, select the machine you want to use, and then click the tab for which you want to change print settings.

 **Note**

- In Windows XP, click **[Preference]** to open the Printing Preferences dialog box.

- 3** Make the settings you require.

- 4** Click **[Print]** to start printing.

Under Windows XP, click **[OK]**, and then click **[Print]** to start printing.

Windows NT 4.0 - Accessing Printer Properties

Changing default settings - Printer properties

 **Limitation**

- Changing machine settings requires Full Control access permission. Members of Administrators, Server Operators, Print Operators, and Power Users groups have Full Control permission by default. When you set up options, log on using an account that has Full Control permission.

- 1** On the **[Start]** menu, point to **[Settings]**, and then click **[Printers]**.

The **[Printers]** window appears.

- 2** Click the icon of the machine whose default you want to change.

- 3** On the **[File]** menu, click **[Properties]**.

The printer properties dialog box appears.

4 Make the settings you require, and then click [OK].

 **Note**

- Normally you do not have to change the “Form to Tray Assignment” settings on the [Device Settings] tab in the PostScript 3 printer driver.
- Settings you make here are used as default for all applications.

Changing the default settings - Default document properties

 **Limitation**

- Changing machine settings requires Full Control access permission. Members of the Administrators, Server Operators, Print Operators, and Power Users groups have Full Control permission by default. When you set up options, log on using an account that has Full Control permission.

1 On the [Start] menu, point to [Settings], and then click [Printers].

The [Printers] window appears.

2 Click the icon of the machine whose default you want to change.

3 On the [File] menu, click [Document Defaults].

The [Default] dialog box appears.

4 Make the settings you require, and then click [OK].

 **Note**

- Settings you make here are used as default for all applications.

Making settings from an application

To make settings for a specific application, open the printer properties dialog box from that application. The following example describes how to make settings for the WordPad application that come with Windows NT 4.0.

 **Note**

- Actual procedures for opening the printer properties dialog box vary depending on the application. For more information, see the operating instructions that come with the application you are using.
- Any setting you make in the following procedure is valid for the current application only.

1 On the [File] menu, click [Print].

The [Print] dialog box appears.

2 In the [Name] list, select the machine you want to use, and then click [Properties].

The printer properties dialog box appears.

3 Make the settings you require, and then click [OK].

4 Click [OK] to start printing.

Macintosh - Setting Up for Printing

Making paper settings from an application

- 1** Open the file you want to print.
- 2** On the [File] menu, click [Page Setup].
The [AdobePS Page Setup] dialog box appears.
- 3** Make sure the machine you want to use is shown in the [Format for:] box.

 **Note**

- In Mac OS X, this is called [Paper Size].
- If the machine is not shown in the [Format for:] box, use the pop-up menu to display a list of available machines.

 **Reference**

The actual appearance of Page Setup depends on the application you are using. See the operating instructions that come with the Macintosh for more information.

- 4** In the [Paper:] box, select the paper size.
- 5** Make the settings you require, and then click [OK].

Setting up for printing from an application

- 1** Open the file you want to print.
- 2** On the [File] menu, click [Print].
The [Printer Features] dialog box appears.
- 3** Make sure the machine is selected in the [Printer:] box.
- 4** Make the settings you require, and then click [Print] to start printing.

Canceling a Print Job

1

Windows - Canceling a Print Job

1 Double-click the printer icon on the Windows taskbar.

A window appears, showing all print jobs currently queued for printing. Check the current status of the job you want to cancel.

2 Select the name of the job you want to cancel.

3 On the **[Document]** menu, click **[Cancel Printing]**.

 **Note**

- In Windows XP and Windows NT, click **[cancel]** on the **[Document]** menu.
- In Windows 95/98/Me, 2000 or NT 4.0, you can also open the print job queue window by double-clicking the machine icon in the **[Printers]** machine window (the **[Printers and Faxes]** window under Windows XP).

4 Press the **[Printer]** key on the machine's control panel.

5 Press **[Job Reset]** on the display panel.

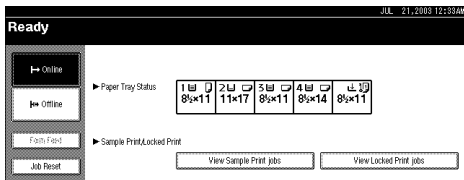

6 Press **[Reset Current Job]** or **[Reset All Jobs]**.



- **[Reset Current Job]**: cancels the print job currently being processed.
- **[Reset All Jobs]**: cancels all jobs in the print queue.
- **[Resume Printing]**: resumes printing jobs.

A confirmation message appears.

7 Press **[Yes]** to cancel the print job.

 **Note**

- Press **[No]** to return to the previous display.

 **Important**

- If the machine is shared by multiple computers, be careful not to accidentally cancel someone else's print job.
- If the machine is connected to the computer using a parallel cable, sent print jobs may be canceled if **[Reset All Jobs]** is pressed while "Waiting..." is on the display panel. After the interval set in **[I/O Timeout]** in Printer Features has passed, the next print job can be sent. A print job sent from a different client computer will not be canceled in this case.

Note

- You cannot stop printing data that has already been processed. For this reason, printing may continue for a few pages after you press **[Job Reset]**.
- A print job containing a large volume of data may take considerable time to stop.

Macintosh - Canceling a Print Job

1 Double-click the printer icon on the desktop.

A window appears, showing all print jobs currently queued for printing. Check the current status of the job you want to cancel.

Note

- In Mac OS X, start Print Center.

2 Select the name of the job you want to cancel.

3 Click the pause icon, and then click the trash icon.

4 Press the **[Printer]** key on the machine's control panel.

5 Press **[Job Reset]** on the display panel.

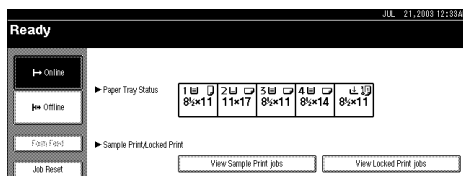

6 Press **[Reset Current Job]** or **[Reset All Jobs]**.



- **[Reset Current Job]**: cancels the print job currently being processed.
- **[Reset All Jobs]**: cancels all jobs in the print queue.
- **[Resume Printing]**: resumes printing jobs.

A confirmation message appears.

7 Press **[Yes]** to cancel the print job.

Note

- Press **[No]** to return to the previous display.

Important

- If the machine is shared by multiple computers, be careful not to accidentally cancel someone else's print job.

Note

- You cannot stop printing data that has already been processed. For this reason, printing may continue for a few pages after you press **[Job Reset]**.
- A print job containing a large volume of data may take considerable time to stop.

2. Using the Document Server

Accessing the Document Server

The Document Server enables you to store documents on the machine's hard disk, allowing you to edit and print as and when you want.

Limitation

- Applications with their own drivers, such as PageMaker, do not support this function.

Reference

For more information about Document Server functions, see *General Settings Guide*.

For information about how to access Document Server from a client, see the printer driver Help.

Note

- When you use the Document Server, the following functions can be selected using the machine's control panel:
 - Copies
 - Collate
 - Duplex
 - Staple
 - Punch
 - Paper selection: Paper source tray, paper type, paper output tray.
 - Functions related to paper selection: Cover sheets, slip sheets, chaptering.
- The above items are dimmed, so you cannot set them from the printer properties dialog box when the Document Server is selected.
- You must enter a user ID, using up to eight alphanumeric characters.
- You should enter a Password and File Name to distinguish the job from others.
- Up to 3,000 files can be stored in the Document Server. No new files can be stored after 3,000 is reached. Even if less than 3,000 files are stored, new files cannot be stored when
 - a file to be stored contains more than 1,000 pages,
 - the total number of pages contained in files stored exceeds 9,000,
 - the hard disk is full.

- ❑ The Document Server also stores files scanned using the Automatic Document Feeder (ADF) or exposure glass. You should delete unnecessary stored files once in a while so as not to exceed the capacity of the hard disk. For how to delete stored files, see *General Settings Guide*.
- ❑ When using the hard disk for functions other than those of Document Server, you may be unable to store new files in the Document Server, even if there are less than 3,000 files stored.

3. Sample Print/Locked Print

Sample Print

Use this function to print only the first set of a multiple-set print job. After you have checked the result, remaining sets can be printed or canceled using the machine's control panel. This can reduce misprints due to mistakes in content or settings.

Note

- If the application has a collate option, make sure it is not selected before sending a print job. By default, sample print jobs are automatically collated by the printer driver. If a collate option is selected from the application's **[Print]** dialog box, more prints than intended may be produced.
- You can identify the file you want to print by user ID and date and time when the job was stored.
- The number of pages the machine can save depends on the contents of the print image. For example, the machine can save up to 30 jobs or 1,000 pages, including locked print files, depending on data volume.
- If the first set of the sample print files is not as you expected and you do not want to print remaining sets, delete the sample print file using the display panel. If you print the remaining sets of the sample print file, the job in the machine is deleted automatically.

Printing a Sample Print File

The following procedure describes how to print a sample print file with the PCL 6/5e printer driver. For information about how to print a sample print file with the PostScript 3 printer driver, see *PostScript 3 Unit Type 2045 Operating Instructions Supplement* included as a PDF file on the CD-ROM.

Limitation

- Applications with their own drivers, such as PageMaker, do not support this function.
- If you are using Mac OS X, this function cannot be used.

1 Configure the sample print in the printer driver's properties.

Reference

For details about configuring the PCL 6/5e or RPCS™ printer driver, see the relevant Help files.

2 Start printing from the application's **[Print]** dialog box.

Note

- Make sure to set more than two copies.

The sample print job is sent to the machine, and the first set is printed.

3 On the machine's control panel, press the **[Printer]** key to display the Printer screen.

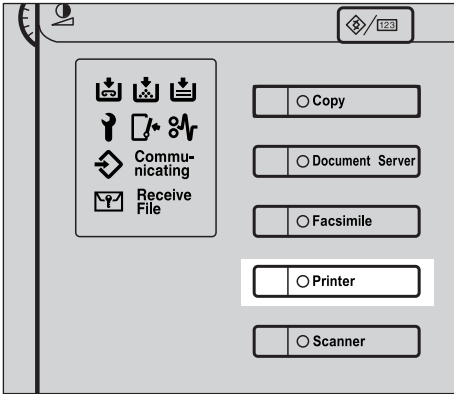

4 Press **[View Sample Print jobs]**.

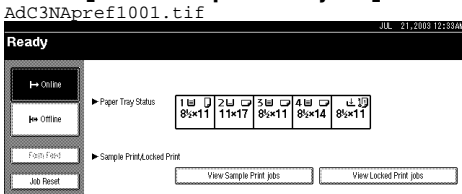

A list of the sample print files stored in the machine appears.

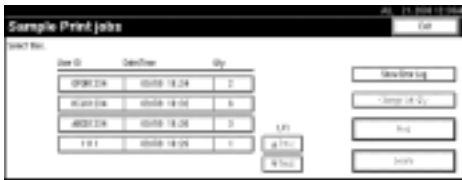

The following items also appear:

- User ID: The user ID set up by the printer driver.
- Date/Time : The date and time when the job was sent from the computer.
- Qty. : The number of remaining sets.

5 Select the file you want to print by pressing it.

Note

- Press **[▲Prev.]** or **[▼Next.]** to scroll through the list.
- Only one file can be selected at a time.

6 Press **[Change Set Qty.]** to change the number of sets to be printed.

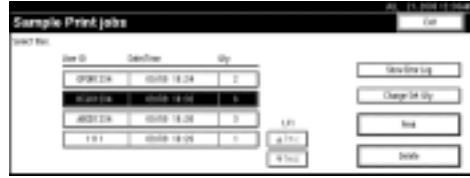

If you do not want to change the set quantity, proceed to step **8**.

7 Enter the new number of sets using the number keys, and then press **[OK]**.

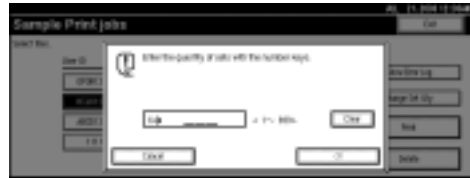

The screen returns to the file list screen.

Note

- You can enter up to 999 sets.
- Press **[Clear]** to correct any entry mistakes.
- If you want to cancel changing the set quantity, press **[Cancel]**.

8 Press **[Print]**.

The print confirmation screen appears.

9 Press **[Yes]**.

The remaining sets are printed.

Note

- Press **[No]** to cancel printing.
- When printing is completed, the stored file will be deleted.
- If printing is stopped by pressing **[Job Reset]** after it has started, the file will be deleted.
- If there is a print job outstanding, this will be printed before the sample print job.

Deleting a Sample Print File

If you are not satisfied with the sample printout, you can delete the sample print file, revise it and print it again until the settings are suitable.

- 1 Press the **[Printer]** key to display the Printer screen.
- 2 Press **[View Sample Print jobs]**.

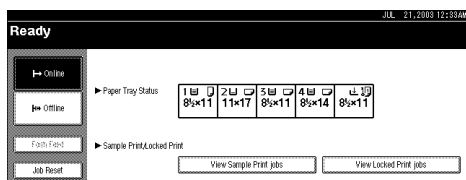

A list of sample print files stored in the machine appears.

- 3 Select the file you want to delete by pressing it.

Note

- Press **[▲Prev.]** or **[▼Next.]** to scroll through the list.
- Only one file can be selected at a time.

- 4 Press **[Delete]**.

The delete confirmation screen will appear.

- 5 Press **[Yes]** to delete the file.

After the file has been deleted, the file list screen will return.

Note

- If you do not want to delete the file, press **[No]**.

Checking the Error Log

If a file could not be stored, you can check the error log on the control panel.

Limitation

- The error log displays only the 20 most recent entries. If the power is turned off, the log is deleted.

- 1 Press the **[Printer]** key to display the Printer screen.

- 2 Press **[View Sample Print jobs]**.

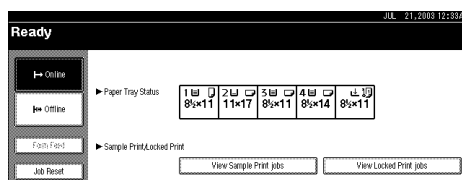

- 3 Press **[Show Error Log]**.

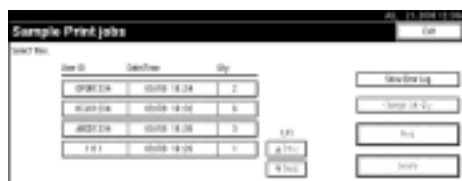

An error log list appears.



Note

- Press **[▲Prev.]** or **[▼Next.]** to scroll through the error files.
- Press **[Exit]** after checking the log.
- To print files that appear in the error log, resend them after stored files have been printed or deleted.

Locked Print

Use this function to maintain privacy when printing confidential documents on the machine over a shared network. Usually, it is possible to print data using the display panel once it is stored in this machine. When using Locked Print, it is not possible to print unless a password is entered on the machine's display panel. Your confidential documents will be safe from being viewed by other people.

Note

- ❑ If the application has a collate option, make sure it is not selected before sending a print job. Locked print jobs are automatically collated by the printer driver as default. If a collate option is selected in the application print dialog box, more sets than intended may be printed.
- ❑ You can identify the file you want to print by User ID, and date and time when the job was stored.
- ❑ The number of pages the machine can save depends on print image content. For example, the machine can save up to 30 jobs or 1,000 pages including sample print files, depending on data volume.
- ❑ After the locked print file is printed, the job is automatically deleted.
- ❑ Turning off the machine's main power switch deletes locked print files.

Printing a Locked Print File

The following procedure describes how to print a locked print file with the PCL 6/5e printer driver. For information about how to print a locked print file with the PostScript 3 printer driver, see *PostScript 3 Unit Type 2045 Operating Instructions Supplement* included as a PDF file on the CD-ROM.

Limitation

- ❑ Applications with their own drivers, such as PageMaker, do not support this function.
- ❑ If you are using Mac OS X, this function cannot be used.

1 Configure the locked print in the printer driver's properties.

Reference

For details about configuring the PCL 6/5e or RPCS™ printer driver, see the corresponding Help files.

2 Start printing from the application's [Print] dialog box.

The locked print job is sent to the machine.

3 On the machine's control panel, press the [Printer] key to display the Printer screen.

4 Press [View Locked Print jobs].

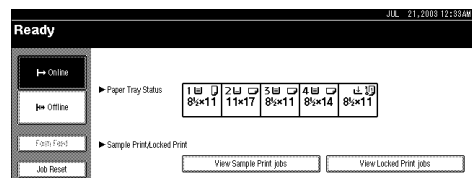

A list of stored locked print files appears.

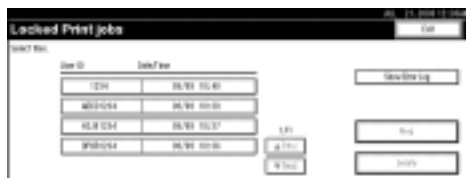

The following items also appear:

- User ID: The user ID set up by the printer driver.
- Date/Time: The date and time when the job was sent from the computer.

5 Select the file you want to print by pressing it.

Note

- Press [**▲Prev.**] or [**▼Next.**] to scroll through the list.
- Only one file can be selected at a time.

6 Press [**Print**].

The password screen appears.



7 Enter the password using the number keys, and then press [**OK**].

The print confirmation screen appears.

Note

- A confirmation screen will appear if the password is not entered correctly. Press [**OK**] to enter the password again.

8 Press [**Yes**].

The locked file is printed.

Note

- Press [**No**] to cancel printing.
- If printing is stopped by pressing [**Job Reset**] after it has started, the file will be deleted.

Deleting Locked Print Files

1 Press the [**Printer**] key to display the Printer screen.

2 Press [**View Locked Print jobs**].

A list of stored locked print files stored appears.

3 Select the file you want to delete by pressing it.

Note

- Press [**▲Prev.**] or [**▼Next.**] to scroll through the list.
- Only one file can be selected at a time.

4 Press [**Delete**].

The password screen is displayed.

5 Enter the password using the number keys, and then press [**OK**].

The delete confirmation screen appears.

Note

- A confirmation screen will appear if the password is not entered correctly. Press [**OK**] to enter the password again.

6 Press **[Yes]**.

After the file has been deleted, the file list screen returns.

Note

- If you do not want to delete the file, press **[No]**.
- If you forget your password, select **[Unlock]** from **[▶Temporarily Unlock Files]** in **[Password Management for Stored Files]** on the **[Key Operator Tools]** tab of the System Settings screen. With this setting, the password screen is not displayed in the procedure above. For more information about **[Display Password with Stored File]**, see *General Settings Guide*.

Note

- Press **[▲Prev.]** or **[▼Next.]** to scroll through the error files.
- Press **[Exit]** after checking the log.
- To print files that appear in the error log, resend them after stored files have been printed or deleted.

3

Checking the Error Log

If a file could not be stored in this machine, you can check the error log on the display panel.

Limitation

- The error log displays only the 20 most recent entries. If the power is turned off, the log will be deleted.

1 Press the **[Printer]** key to display the Printer screen.

2 Select **[View Locked Print jobs]**.

3 Press **[Show Error Log]**.

An error log list appears.

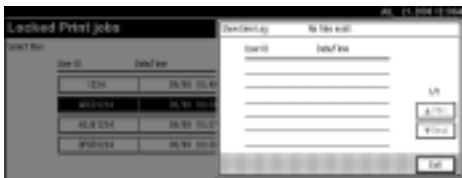

Form Feed

This section gives instructions for operating the machine when there is no tray for the selected paper size or type, or when paper loaded in the machine has run out.

Limitation

- The tray cannot be changed if the following functions are set for it:
 - Staple
 - Punch
 - Duplex Print to a tray that does not support duplex printing
 - Cover Sheet
 - Front/Back Covers
 - Slip Sheets
 - Chaptering

Note

- If form feed is selected for a tray with the following settings, you can change the tray by canceling the settings:
 - Staple
 - Punch
- If Auto Continue is selected, form fed paper is printed after a set interval. See p.42 "System".

If the machine does not have a tray for the selected paper size or paper type, or if the selected paper loaded in the machine has run out, a caution message appears.

If this message appears, do one of the following:

Print Using a Selected Tray

- 1** Select the tray for form feed from those that appear on the display panel.

If you want to print after adding paper to the tray, select the tray after loading the correct paper.

Note

- To load paper in the bypass tray, see "Setting Paper on the Bypass Tray", *Printer Reference 1*.

- 2** Press [Continue].

The machine prints using the selected tray.

Note

- If a tray with a smaller paper size is selected, the print job may be cut short, or other problems may occur.

Canceling Form Feed

1 Press [Reset].

Delete the stored print job, and then cancel form feed.

2 Press [Reset Current Job] or [Reset All Jobs].



- **[Reset Current Job]:** cancels the print job currently being processed.
- **[Reset All Jobs]:** cancels all jobs in the print queue.
- **[Resume Printing]:** resumes printing jobs.

A confirmation message appears.

3 Press [Yes] to cancel the print job.

Note

- Press **[No]** to return to the previous display.

Important

- If the machine is shared by multiple computers, be careful not to accidentally cancel someone else's print job.
- Under Windows, If the machine is connected to the computer using a parallel cable, sent print jobs may be canceled if **[Reset All Jobs]** is pressed while "Waiting..." is on the display panel. After the interval set in **[I/O Timeout]** in Printer Features has passed, the next print job can be sent. A print job sent from a different client computer will not be canceled in this case.

Note

- You cannot stop printing data that has already been processed. For this reason, printing may continue for a few pages after you press **[Job Reset]**.
- A print job containing a large volume of data may take considerable time to stop.

Reference

p.10 "Canceling a Print Job"

4. Troubleshooting

Error & Status Messages on the Display Panel

This section describes the principal messages that appear on the panel display. If a message not described here appears, act according to the message.

Reference

Before turning the main power off, see 'Turning On the Power', General Settings Guide.



❖ Status messages

Message	Status
Hex Dump Mode	In Hex Dump mode, the machine receives data in hexadecimal format. Turn off the machine after printing, and then turn back on.
Offline	The machine is offline. To start printing, switch the machine online by pressing [Offline] on the display panel.
Please wait.	The machine is preparing the development unit. Wait a while.
Printing...	The machine is printing. Wait a while.
Ready	This is the default ready message. The machine is ready for use. No action is required.
Resetting job...	The machine is resetting the print job. Wait until "Ready" appears on the display panel.
Waiting...	The machine is waiting for the next data to print. Wait a while.



❖ Alert messages

Messages/Second messages	Causes	Solutions
Cannot connect with the wireless card.	The IEEE 802.11b card may have come off, or an error may have occurred in the IEEE 802.11b card.	Turn off the main power switch, and check the card is installed correctly. If the message appears again, contact your sales or service representative.
Close duplex unit cover.	The cover of the duplex unit is open.	Close the cover of the duplex unit.
Collate has been cancelled.	The collate print function has been canceled.	Turn off the main power switch, and back on again. If the message appears again, contact your sales or service representative.

Messages/Second messages	Causes	Solutions
DIMM has a problem.	An error has occurred in the DIMM inside the machine.	Contact your sales or service representative.
Driver setting error. (Memory)	There is an error in the downloaded font(s).	Reset the parameter for downloading fonts.
	Insufficient memory or memory settings for the printer driver may not match memory actually installed.	Specify correct memory capacity on the [Change Accessories...] tab in the RPCS™ printer driver.
		To print the image correctly, increase memory capacity, or reduce resolution image.
Duplex has been cancelled.	Duplex printing has been canceled.	Check the paper used is suitable for duplex printing. Or, increase memory capacity. When installing a memory module in the machine, contact your sales or service representative.
Ethernet board has a problem.	An error has occurred in the Ethernet board.	Turn off the main power switch, and back on again. If the message appears again, contact your sales or service representative.
Exceeded max capacity of document server. Cannot stored.	Hard disk drive capacity exceeded storing to the Document Server.	Delete some files stored in the Document Server or decrease the file size to be downloaded.
Exceeded max number of files of document server. Cannot stored.	The maximum number of files stored in the Document Server has been exceeded.	Delete some files stored in the Document Server.
Exceeded max number of pages of document server. Cannot stored.	The maximum number of pages stored in the Document Server has been exceeded.	Delete some pages stored in the Document Server or decrease the number of pages to be downloaded.
Exceeded max. stored files in sample print and locked print.	The maximum number of stored files has been exceeded during Sample Print or Locked Print.	Delete some stored files or reduce file sizes.
Exceeded max. stored pages in sample print and locked print.	The maximum number of stored pages has been exceeded during Sample Print or Locked Print.	Reduce the number of pages to be printed.

Messages/Second messages	Causes	Solutions
Exceeded max. pages. Collate is incomplete.	The maximum number of pages has been exceeded for collation.	Turn off the main power switch, and back on again. Reduce the number of pages to be printed. If the message appears again, contact your sales or service representative.
Finisher is in use for another function. Please wait.	The finisher is in use by another function, such as the copier function.	Wait until the other function has finished using the finisher.
Following output tray is full. ### Remove the paper. ###	The indicated output tray is full.  Note <input type="checkbox"/> "###" in the message represents a output tray.	Remove the paper.
HDD has a problem.	An error has occurred in the hard disk drive.	Turn off the main power switch, and back on again. If the message appears again, contact your sales or service representative.
HDD has not been installed.	Locked Print was performed without the hard disk installed, or the hard disk is damaged.	Contact your sales or service representative.
HDD is full.	The maximum hard disk area size for form/font has been exceeded.	Delete unused form /font types.
	An HDD overflow error occurred during Sample Print or Locked Print.	Delete some stored files, or reduce the size of the file to be downloaded.
IEEE 802.11b (Wireless LAN) has a problem.	IEEE 802.11b card was not inserted when the machine was turned on, or it was pulled out after the machine turned on.	Turn off the machine and check the IEEE 802.11b card is inserted correctly. Then, turn the machine on again. If the message appears again, call your service center.
LCT has a problem. Turn Main Power Switch off then on. If the error appears again, call service representative.	An error has occurred in the Large Capacity Tray (LCT).	Turn off the main power switch, wait five minutes, and on again. If the message appears again, call your sales or service representative.
 Lower Staple is almost empty.	There are only a few staples left in the lower stapler.	Load more staples.

Messages/Second messages	Causes	Solutions
NV-RAM has a problem.	An error has occurred in the optional memory unit.	Turn off the main power switch, and back on again. If the message appears again, call your sales or service representative.
Output tray has been changed.	The output tray has been changed because of the paper size limitation of the selected tray.	Select the correct output tray.
Paper in duplex unit. Open cover and remove paper.	There is a misfeed in the duplex unit.	Open the cover of the duplex unit, and remove the misfed paper.
Paper in staple tray. Open finisher cover and remove paper.	There is paper remaining inside the finisher.	Open the cover of the finisher, and remove the paper.
Parallel I/F board has a problem.	An error has occurred in the parallel interface board.	Contact your sales or service representative.
Print overrun.	The image data has been thinned out due to image compression.	Increase memory capacity. When installing a memory module in the machine, contact your sales or service representative.
Problems with the wireless board.	An error may have occurred in the IEEE 802.11b card (wireless LAN board).	Turn off the main power switch, and back on again. If the message appears again, contact your sales or service representative.
Problems with the wireless card.	An error may have occurred in the IEEE 802.11b card.	
Punch has been cancelled.	Punch has been cancelled.	Check the paper feed direction, paper orientation, and punch position.
RPCS graphic error.	There is insufficient graphics memory to print the data.	Specify the correct memory capacity on the [Change Accessories...] option in the RPCS™ printer driver.
		To print the image correctly, install more memory in the machine, or reduce image resolution.
RPCS memory overflow.	A memory overflow occurred during the print job. After part of the data is printed, the print job is suspended.	To print the image correctly, install more memory in the machine, or reduce image resolution.

Messages/Second messages	Causes	Solutions
RPCS syntax error.	Bidirectional transmission may not be working properly, or the RPCS™ printer driver settings may not be correct.	Confirm the option settings for the printer driver match the options installed on the machine.
Selected paper tray is in use for another function. Please wait.	The specified paper tray is in use by another function, such as the copier function.	Wait until the other function has finished using the specified paper tray.
Shift tray has a problem. Call service representative. 	A malfunction occurs when using the shift function.	Contact your sales or service representative.
Staple has been cancelled.	Staple printing has been canceled.	Check the paper feed direction, paper orientation and stapling position.
Staple unit is in use for another function. Please wait.	The staple unit is in use by another function, such as the copier function.	Wait until the other function has finished using the staple unit.
 Toner is almost empty.	The toner has almost run out.	Replace the toner cartridge with a new one.
Turn the main power switch off, then check the card.	The IEEE 802.11b card may have come off, or an error may have occurred in the IEEE 802.11b card.	Turn off the main power switch, and check the card is installed correctly. If the message appears again, contact your sales or service representative.
Unauthorized user access. Print job has been cancelled.	Print job canceled due to user restrictions.	Check the User Code permission status.
USB has a problem.	An error has occurred in the USB interface.	Turn off the main power switch, and back on again. If the message appears again, contact your sales or service representative.

The Machine Does Not Print

4

Possible Cause	Solutions
Is the power on?	Check the cable is securely plugged into the power outlet and the machine. Turn on the main power switch.
Is the machine online?	If not, press [↔ Online] on the display panel.
Does the printer function status indicator stay red?	If so, check the error message on the display panel and take required action.
Is there a warning status or error message on the display panel?	If so, check the error message or warning status on the display panel and take the required action.
Can you print a configuration page?	If you cannot print a configuration page, there maybe a machine malfunction. Contact your sales or service representative. See p.38 "Printing the configuration page" for printing a configuration page.
Is the interface cable connected securely to the machine and computer?	Connect the interface cable securely. If it has a fastener, fasten that securely as well. See "Connecting the Machine", <i>Printer Reference 1</i> .
Are you using the correct interface cable?	The type of interface cable you should use depends on the computer. Be sure to use the correct one. If the cable is damaged or worn, replace it. See "Connecting the Machine", <i>Printer Reference 1</i> .
Was the interface cable connected after the machine was turned on?	Connect the interface cable <i>before</i> turning on the machine.
Is the signal status satisfactory when using wireless LAN in infrastructure mode ?	To check signal status, press [User Tools/Counter] on the display panel, and then press [System Settings] on the display panel. On the [Interface Settings] tab, select [IEEE 802.11b], and then press [Wireless LAN Signal]. If signal quality is poor, move the machine to a location where radio waves can pass or remove objects that might cause interference.  Note <input type="checkbox"/> You can check signal status only when using wireless LAN in infrastructure mode.
When using wireless LAN, is the SSID correctly set?	Check using the machine's display panel that the SSID is correctly set. See "Interface Settings/IEEE 802.11b (Option)", <i>General Settings Guide</i> .

Possible Cause	Solutions
When using wireless LAN, is the access point correctly set?	<p>Check access point settings when in infrastructure mode. Depending on the access point, client access may be limited by MAC address.</p> <p>Also, check there are no problems in transmission between access point and wired clients, and between access point and wireless clients.</p>
When using wireless LAN, is the LED on the wireless LAN card lit or blinking?	<p>Confirm the orange LED is lit, and the green LED is lit or blinks during transmission.</p>
Is the wireless LAN being used in ad hoc mode?	<p>Turn the main power off and back on. See “Turning On the Power”, General Settings Guide.</p> <p>Otherwise, configure [Network] in [Interface Settings] in [System Settings]. See “Setting Up the Machine on a Network”, Network Guide.</p>
Did you change the option settings on the machine?	<p>When using the RPCS™ printer driver on Windows 2000 and connecting with IEEE 1394, an error may occur if you change the option settings on the machine. In this case, follow the procedure below:</p> <ol style="list-style-type: none"> ① Unplug the IEEE 1394 interface cables connected to the computer. ② Run the utility tool for the IEEE 1394 interface board, which is stored in the following path on the CD-ROM “Printer Drivers and Utilities”. <code>\UTILITY\1394\</code> <p> Reference</p> <p>For more information about using the utility tool for IEEE 1394, see the README file in the same directory on the CD-ROM.</p> ③ Restart the computer. ④ Connect the computer to the machine using the IEEE 1394 interface cables.



Problem	Solutions
<p>Is the Data In indicator blinking or lit after starting the print job?</p>	<p>If not, data is not being sent to the machine.</p> <ul style="list-style-type: none"> ❖ When the machine is connected to the computer using the interface cable <p>Check the machine port settings are correct. For parallel port connection, port LPT1 or LPT2 should be set.</p> <ul style="list-style-type: none"> • Windows 95/98/Me <ol style="list-style-type: none"> ① Click the [Start] button, point to [Settings], and then click [Printers]. ② Click the icon of the machine. On the [File] menu, click [Properties]. ③ Click the [Details] tab. ④ In the [Print to the following port(s)] list, confirm the correct port is selected. • Windows 2000 <ol style="list-style-type: none"> ① Click the [Start] button, point to [Settings], and then click [Printers]. ② Click the icon of the machine. On the [File] menu, click [Properties]. ③ Click the [Ports] tab. ④ In the [Print to the following port(s)] list, confirm the correct port is selected. • Windows XP Professional <ol style="list-style-type: none"> ① Click the [Start] button, and then click [Printers and Faxes]. ② Click the icon of the machine. On the [File] menu, click [Properties]. ③ Click the [Ports] tab. ④ In the [Print to the following port(s)] list, confirm the correct port is selected. • Windows XP Home Edition <ol style="list-style-type: none"> ① Click the [Start] button, click [Control Panel], click [Printers and Other Hardware], and then click [Printers and Faxes]. ② Click the icon of the machine. On the [File] menu, click [Properties]. ③ Click the [Ports] tab. ④ In the [Print to the following port(s)] list, confirm the correct port is selected. • Windows NT 4.0 <ol style="list-style-type: none"> ① Click the [Start] button, point to [Settings], and then click [Printers]. ② Click the icon of the machine. On the [File] menu, click [Properties]. ③ Click the [Ports] tab. ④ In the [Print to the following port(s)] list, confirm the correct port is selected. ❖ Network connection <p>Contact your network administrator.</p>

Other Printing Problems

Problem	Causes and Solutions
The print on the entire page is faded.	If [Toner Saving] is selected on the [Print Quality] tab in the printer driver, the entire page will be faded when printed. See the printer driver Help.
Print is smudged.	Settings for thick paper have not been made when printing on thick paper. <ul style="list-style-type: none"> • PCL 6/5e and PostScript 3 Select [Thick] in the [Type:] list on the [Paper] tab. • RPCS™ Select [Thick] in the [Paper type:] list on the [Print Settings] tab.
When printing graphics, the output and the screen are different.	If the printer driver is configured to use the graphics command, the graphics command from the machine is used to print. If you want to print accurately, set the printer driver to print without using the graphics command. See the printer driver Help.
Page layout is not as expected.	Print areas differ depending on machine used. Information that fits on a single page on one machine may not fit on a single page of another machine. Adjust the [Printable area:] setting in the [Printer Configuration] dialog box on the [Print Settings] tab in the RPCS™ printer driver. See the printer driver Help.
printing is malfunctioning.	<ul style="list-style-type: none"> • Duplex printing cannot be done with paper set in the bypass tray. When using duplex printing, make settings to use paper from a tray other than the bypass tray. • Duplex printing cannot be done with thick paper, OHP transparencies, or labels specified as the paper type. Specify another paper type. • Duplex printing cannot be done with a tray for which [1 Sided Copy] has been specified as Paper Type on the System Settings menu. Change the Paper Type setting for the tray to [2 Sided Copy] on the System Settings menu. See <i>General Settings Guide</i>.
When using Windows 95/98/Me, Windows 2000/XP, or Windows NT 4.0, either combined printing or booklet print does not come out as expected.	Make sure the application's paper size and orientation settings match those of the printer driver. If a different paper size and orientation are set, select the same size and orientation.
When using Windows 95/98/Me, Windows 2000/XP, or Windows NT 4.0, Auto Reduce/Enlarge print does not come out as expected.	

Problem	Causes and Solutions
A print instruction was issued from the computer, but printing did not start.	User code management may have been set. Ask the administrator about valid user codes. To print, the user code must be entered from the printer driver.
The print job is not canceled even when the machine is switched to offline status.	Even when the machine is offline, printing is performed when [Job acceptance priority] has been set in Signal Control in the System Settings menu. Change the setting of Signal Control to Printer priority. See “User Tools (System Settings)”, <i>General Settings Guide</i> .
Photo images are coarse.	Some applications reduce print resolution.
Fine dot pattern does not print.	<p>Make the following settings with the printer driver:</p> <ul style="list-style-type: none"> • Change the [Dithering:] setting on the [Image Adjustments] tab in the [Change User Settings...] dialog box on the [Print Quality] tab in the RPCS™ printer driver. <p>See the printer driver Help.</p>
Images are cut off, or excess is printed.	<p>You may be using paper smaller than the size selected in the application. Use the same size paper as that selected in the application. If you cannot load paper of the correct size, use the reduction function to reduce the image, and then print.</p> <p>See the printer driver Help.</p>
It takes a long time to complete a print job.	<p>Photographs and other data intensive pages take a long time for the machine to process, so simply wait when printing such data.</p> <p>Changing the following settings with the printer driver may help speed up printing:</p> <ul style="list-style-type: none"> • PCL 6/5e Select the lowest value for [Resolution] on the [Print Quality] tab in the printer properties dialog box. • PostScript 3 Select the lowest value for [Resolution] on the [Print Quality] tab in the printer properties dialog box. Select [PostScript (optimize for speed)] for [PostScript output format:] on the [PostScript] tab in the printer properties dialog box. • RPCS™ Select the lowest value for [Resolution] on the [Image Adjustments] tab in the [Change User Settings...] dialog box on the [Print Quality] tab in the printer properties dialog box. Select [Fast] for [Document type] list on the [Print Quality] tab in the printer properties dialog box. <p>See the printer driver Help.</p>
	<p>The data is so large or complex that it takes time to process. If the Data In indicator is blinking, data is being processed. Simply wait until printing resumes.</p>

Problem	Causes and Solutions
It takes too much time to resume printing.	The data is so large or complex that it takes time to process. If the Data In indicator is blinking, data is being processed. Simply wait until printing resumes.
	The machine was in Energy Saver mode. To resume from Energy Saver mode, it has to warm up, and this takes time. To disable Energy Saver mode, select [Off] for Energy Saver 1 in the System Settings menu. See <i>General Settings Guide</i> .
Paper is not fed from the selected tray.	When you are using a Windows operating system, printer driver settings override those set using the display panel. Set the desired input tray using the printer driver. See the printer driver Help.
Solid lines are printed as broken lines.	Make the following settings with the printer driver: <ul style="list-style-type: none"> • Change the [Dithering:] setting on the [Image Adjustments] tab in the [Change User Settings...] dialog box, on the [Print Quality] tab in the RPCS™ printer driver. See the printer driver Help.
Optional components connected to the machine are not recognized when using Windows 95/98/Me, Windows 2000/XP, and Windows NT 4.0.	You have to configure the option setup in printer properties when bidirectional transmission is not enabled. See the printer driver Help.
Images are printed in the wrong orientation.	The feed orientation you selected and the feed orientation selected in the printer driver's option setup might not be the same. Set the machine's feed orientation and the printer driver's feed orientation accordingly. See the printer driver Help.
The printed image is different from the image on the computer's display.	With certain functions, such as enlargement and reduction, image layout might be different to that on the computer display.
	You might have selected to replace True Type fonts with machine fonts in the printing process. To print an image similar to that of the computer display, make settings to print True Type fonts as an image. See the printer driver Help.

Problem	Causes and Solutions
<p>No transmission when using 1394 interface connection</p>	<p>Check using the following procedure:</p> <ol style="list-style-type: none"> ① Confirm the IEEE 1394 interface cable is connected securely. ② Restart the computer. If the error occurs even after executing the above operation, proceed to the following steps. ③ Unplug the IEEE 1394 interface cable connected to the computer. ④ Run the utility tool for the IEEE 1394 interface board, which is stored in the following path on the CD-ROM "Printer Drivers and Utilities": <code>\UTILITY\1394\</code> <p> Reference For more information about using the utility tool for IEEE 1394, see the README file in the same directory on the CD-ROM.</p> <ol style="list-style-type: none"> ⑤ Restart the computer.
<p>Printing stops and a paper error is displayed if the custom size paper in the paper feed tray is specified when printing with the Post-Script 3 printer driver.</p>	<p>Follow the one of the procedures below:</p> <ul style="list-style-type: none"> • Press [Job Reset] on the display panel to stop printing. Place the custom size paper in the bypass tray, and then start printing. • Select the paper feed tray with custom size paper, and then press [Continue] to force printing.
<p>When connecting the machine using USB 2.0, the first page of a print job that contains a large volume of data is printed, but the remaining pages are not.</p>	<p>Check that USB Printing Support is installed on your computer.</p> <p> Reference See "Installing the Printer Driver Using USB", <i>Printer Reference 1</i>.</p>

 **Note**

If the problem cannot be solved, contact your sales or service representative.

5. Printer Features

Reference

For more information about copier features and system settings, see *Copy Reference* and *General Settings Guide*.

Printer Features Menu

There are seven menu items in the Printer Features menu:

- Paper Input
- List/Test Print
- Maintenance
- System
- Host Interface
- PCL Menu
- PS Menu (optional)

You can select the functions in the following table:

Menu	Default
Paper Input See p.38 "Paper Input".	Bypass Paper Size
List/Test Print See p.38 "List/Test Print".	Config. Page
	Menu List
	PCL Config./ Font Page
	PS Config./ Font Page * ¹
Hex Dump	
Maintenance See p.41 "Maintenance".	Menu Protect

Menu	Default
System See p.42 "System".	Print Error Report
	Auto Continue
	Memory Overflow
	Job Separation *2
	Memory Usage
	Duplex
	Copies
	Edge Smoothing
	Toner Saving
	Printer Language
	Sub Paper Size
	Page Size
	Letterhead Setting
	Edge to Edge Print
Default Printer Language	
Host Interface See p.44 "Host Interface".	I/O Buffer
	I/O Timeout
PCL Menu See p.45 "PCL Menu".	Orientation
	Form Lines
	Font Source
	Font Number
	Point Size
	Font Pitch
	Symbol Set
	Courier Font
	Extend A4 Width
	Append CR to LF
	Resolution
PS Menu (optional) See p.46 "PS Menu".	Data Format
	Resolution

*1 Appears when the PostScript 3 unit (optional) is installed.

*2 Appears when the finisher (optional) is installed.

Adjusting Printer Features

Printer Features allows basic adjustment of operations when using the machine as a printer.

Although factory default settings are suitable for most printing jobs, Printer Features gives you access to a number of settings that control basic printer operations. Printer Features settings you make are retained even when you turn off the machine.

For more information about copier features and system settings, see *Copy Reference* and *General Settings Guide*.

- 1** Press the **[User Tools/Counter]** key on the control panel.
- 2** Press **[Printer Features]**.
- 3** Select the desired item by pressing the tab, and then change its settings.

 **Note**

- [OK]**: Press to make new settings and go back to previous menus.
- [Cancel]**: Press to return to a previous menu without changing any setting.

- 4** After changing Printer Features settings, press **[Exit]** to return to the User Tools/Counter menu.

 **Note**

- You can also exit from the User Tools/Counter menu by pressing the **[User Tools/Counter]** key.
- Changes made to functions remain in effect even if the machine is turned off.
- You can also exit from the Printer Features menu by pressing **[Exit]** in the main menu.

Printer Features Parameters

Paper Input

❖ Bypass Paper Size

The size of the paper set in the bypass tray.

Reference

For more information about paper sizes that can be set in the bypass tray, see *General Settings Guide*.

For information about setting paper in the bypass tray, see *Printer Reference 1*.

Note

- Default:
 - Metric version: A4
 - Inch version: 11 × 8½

List/Test Print

❖ Config. Page

You can print the machine's current configuration values.

Reference

p.38 “Printing the configuration page”

❖ Menu List

You can print a Menu List showing the machine's function menus.

❖ PCL Config./ Font Page

You can print the current configuration of installed PCL fonts.

❖ PS Config./ Font Page

You can print the current configuration of installed PostScript fonts.

Note

- This menu can be selected only when the optional PostScript 3 board is installed.

❖ Hex Dump

You can print the Hex Dump.

Printing the configuration page

1 Press the **[User Tools/Counter]** key on the control panel.

The User Tools/Counter menu appears.

2 Press **[Printer Features]**.

The Printer Features menu appears.



3 Press **[Config. Page]** on the **[List/Test Print]** tab.

The configuration page is printed.

Interpreting the configuration page

System Reference

❖ Unit Number

Displays the serial number assigned to the board by its manufacturer.

❖ Total Memory

Displays the total amount of memory (SDRAM) installed on the printer.

❖ Firmware Version

- Firmware
Displays the version number of the printer firmware.
- System
Displays the version number of the system firmware.
- Engine
Displays the version number of the printer engine.
- Panel
Displays the version number of the panel display.
- NIB
Displays the version number of the Network interface.

❖ HDD: Font/ Macro Download

Displays the capacity of the hard disk drive.

❖ Controller Option

This item(s) appears when the controller option(s) is installed.

❖ Printer Language

Displays the version number of the printer driver language.

❖ Options

Displays the optional trays installed.

Paper Input

Displays the settings made under the Paper Input menu.

Reference

p.38 "Paper Input"

System

Displays the settings made under the System menu.

 **Reference**
p.42 "System"

PCL Menu

Displays the settings you made under PCL Menu.

 **Reference**
p.45 "PCL Menu"

PS Menu

Displays the settings you made under PS Menu.

 **Reference**
p.46 "PS Menu"

Host Interface

Displays the settings you made under the Host Interface menu.

When DHCP is active on the network, the actual IP address, subnet mask and gateway address appear in parentheses on the configuration page.

 **Reference**
p.44 "Host Interface"

Interface Information

Displays the interface information.

Error Log

Displays the printer error log.

Maintenance

❖ Menu Protect

This procedure lets you protect menu settings from accidental change. It makes it impossible to change menu settings with normal procedures unless you perform the required key operations. In a network environment, only administrators can make changes to menu settings.

- Level 1
You can protect "Maintenance", "System", "Host Interface" and "PCL Menu".
- Level 2
You can protect "Paper Input", "Maintenance", "System", "Host Interface" and "PCL Menu".
- Off

Note

- Default: *Off*
- You can protect menu settings using a Web browser.

Setting Menu Protect

- 1** Press the **[User Tools/Counter]** key on the control panel.
The User Tools/Counter menu appears.
- 2** Press **[Printer Features]**.
The Printer Features menu appears.
- 3** Press **[Maintenance]**.
- 4** Press **[Menu Protect]**.
- 5** Enter an access code using the number keys, and then press **[OK]**.

- 6** Select a menu protect level, and then press **[OK]**.

- 7** Press **[Exit]**.

The User Tools/Counter menu appears.

- 8** Press **[Exit]**.

Note

- You can also exit the User Tools/Counter menu by pressing the **[User Tools/Counter]** key.

Canceling Menu Protect

- 1** Press the **[User Tools/Counter]** key on the control panel.

- 2** Press **[Printer Features]**.

- 3** Press **[Maintenance]**.

A screen for entering the access codes appears.

- 4** Enter an access code using the number keys, and then press **[OK]**.

- 5** Press **[Menu Protect]**.

- 6** Select **[Off]**, and then press **[OK]**.

- 7** Press **[Exit]**.

The User Tools/Counter menu appears.

- 8** Press **[Exit]**.

Note

- You can also exit the User Tools/Counter menu by pressing the **[User Tools/Counter]** key.

Temporarily canceling Menu Protect

When you select protected items in Printer Features, a screen for entering the access codes appears. When this happens, enter the correct access codes using the number keys, and then press **[OK]**. Menu Protect is then temporarily canceled.

Note

- If you enter the correct access codes, Menu Protect remains canceled while the Printer Features menu is displayed.

System

❖ Print Error Report

Select this to have an error report printed when a printer or memory error occurs.

- On
- Off

Note

- Default: *Off*

❖ Auto Continue

You can select this to enable Auto Continue. When it is On, printing continues after a system error occurs.

- Off
- 0 minute
- 1 minute
- 5 minutes
- 10 minutes
- 15 minutes

Note

- Default: *Off*

❖ Memory Overflow

Select this to have a memory overflow error report printed.

- Not Print
- Error Report

Note

- Default: *Not Print*

❖ Job Separation

You can enable Job Separation.

- On
- Off

Note

- Default: *Off*
- This menu appears only when the optional finisher is installed.

❖ Memory Usage

You can select the amount of memory used in Font Priority or Frame Priority, according to paper size or resolution.

- Font Priority
This setting uses memory for registering fonts.
- Frame Priority
This setting uses frame memory for high speed printing.

Note

- Default: *Frame Priority*

❖ Duplex

You can select to have print on both sides of each page.

- Off
- Short Edge Bind
- Long Edge Bind

Note

- Default: *Off*

❖ **Copies**

You can specify the number of print sets. This setting is disabled if the number of pages to print has been specified with the printer driver or another command.

- 1 to 999 by 1

✎ **Note**

- Default: 1

❖ **Edge Smoothing**

Set this to enable Edge Smoothing.

- On
- Off

✎ **Note**

- Default: *On*

- If Toner Saving is set to On, Edge Smoothing is ignored even if it is set to On.

❖ **Toner Saving**

Set this to enable Toner Saving.

- On
- Off

✎ **Note**

- Default: *Off*

❖ **Printer Language**

Normally, the machine should be set to Auto. If the printer language cannot be detected in Auto, the language specified by Default Printer Language is selected.

- Auto
- PCL
- PS

✎ **Note**

- Default: *Auto*

- PS appears only when the optional PostScript 3 board is installed.

❖ **Sub Paper Size**

You can enable the Auto Substitute Paper Size (A4↔LT) feature.

- Auto
- Off

✎ **Note**

- Default: *Off*

❖ **Page Size**

You can select the default paper size.

- 11 × 17
- 8¹/₂ × 14
- 8¹/₂ × 11
- 5¹/₂ × 8¹/₂
- 7¹/₄ × 10¹/₂
- 8 × 13
- 8¹/₂ × 13
- 8¹/₄ × 13
- A3
- B4 JIS
- A4
- B5 JIS
- A5
- A6
- Custom Size

✎ **Note**

- Default:

- Metric version: A4
- Inch version: 8¹/₂ × 11

❖ Letterhead Setting

You can rotate original images when printing.

When printing, original images are always rotated by 180 degrees. Therefore, output might not be as expected when printing onto letterhead or preprinted paper requiring orientation. Using this function, you can specify image rotation.

- Off
- Auto Detect
- On (Always)

Note

- Default: *Off*
- When set to Off, original images are rotated by 180 degrees.
- When set to Auto Detect, the machine detects a letterhead or preprinted paper automatically, and does not rotate them.
- When set to On (Always), the machine does not rotate.
- This function reduces printing speed.

❖ Edge to Edge Print

Select this to maximize the printable area by minimizing white space along the edges, to 0.04 inches (1 mm).

- Off
- On

Note

- Default: *Off*

❖ Default Printer Language

You can set the default printer language if the machine cannot find the printer language automatically.

- PCL
- PS

Note

- Default: *PCL*
- PS appears only when the optional PostScript 3 board is installed.

Host Interface

❖ I/O Buffer

You can set the size of the I/O Buffer. Normally it is not necessary to change this setting.

- 128 KB
- 256 KB
- 512 KB

Note

- Default: *128 KB*

❖ I/O Timeout

You can set how many seconds the machine should wait before ending a print job. If data from another port usually arrives in the middle of a print job, you should increase this timeout period.

- 10 seconds
- 15 seconds
- 20 seconds
- 25 seconds
- 60 seconds

Note

- Default: *15 seconds*

PCL Menu

❖ Orientation

You can set the page orientation.

- Portrait
- Landscape

Note

- Default: *Portrait*

❖ Form Lines

You can set the number of lines per page.

- 5 to 128 by 1

Note

- Default:
 - Metric version: 64
 - Inch version: 60

❖ Font Source

You can set the storage location of the default font.

- Resident
- RAM
- HDD

Note

- Default: *Resident*
- RAM and HDD can be selected only when fonts have been downloaded to the machine.

❖ Font Number

You can set the ID of the default font you want to use.

- 0 to 50 by 1

Note

- Default: 0

❖ Point Size

You can set the point size you want to use for the selected font.

- 4.00 to 999.75 by 0.25

Note

- Default: 12.00
- This setting is effective only with variable-space fonts.

❖ Font Pitch

You can set the number of characters per inch for the selected font.

- 0.44 to 99.99 by 0.01

Note

- Default: 10.00
- This setting is effective only with fixed-space fonts.

❖ Symbol Set

You can specify the set of print characters for the selected font. The available options are as follows:

Roman-8, ISO L1, ISO L2, ISO L5, PC-8, PC-8 D/N, PC-850, PC-852, PC8-TK, Win L1, Win L2, Win L5, Desktop, PS Text, VN Intl, VN US, MS Publ, Math-8, PS Math, VN Math, Pifont, Legal, ISO 4, ISO 6, ISO 11, ISO 15, ISO 17, ISO 21, ISO 60, ISO 69, Win 3.0

Note

- Default: *Roman-8*

❖ Courier Font

You can select a courier font type.

- Regular
- Dark

Note

- Default: *Regular*

❖ Extend A4 Width

You can extend the printing area width (when printing on A4 sheet with PCL).

- On
- Off

Note

- Default: *Off*
- When the setting is On, the width will be 8½ inches.

❖ Append CR to LF

When set to On, a carriage return will follow each line feed: CR=CR, LF=CR-LF, FF=CR-FF.

- Off
- On

Note

- Default: *Off*

❖ Resolution

You can set the print resolution in dots per inch.

- 300 dpi
- 600 dpi

Note

- Default: *600 dpi*

PS Menu

❖ Data Format

You can select a data format.

- Binary data
- TBCP

Limitation

- This setting is not effective when operating the machine with a parallel, USB, or EtherTalk connection.
- When operating the machine with a parallel or USB connection, if binary data is sent from the printer driver, the print job is canceled.
- When operating the machine with an Ethernet connection, the print job is canceled under the following conditions;
 - The printer driver data format is TBCP, and the data format selected on the display panel is Binary Data.
 - The printer driver data format is binary, and the data format selected on the display panel is TBCP.

Note

- Default: *Binary data*

❖ Resolution

You can set the print resolution in dots per inch.

- 300 dpi
- 600 dpi

Note

- Default: *600 dpi*

Finisher

You can collate, staple or punch holes in printed paper by installing the optional finisher. Make sure you read the following precautions when using the optional finisher:

Reference

For information about optional finishers, see *General Settings Guide*.

To use the staple function, see p.48 “Staple”.

To use the punch function, see p.52 “Punch”.

❖ **Be sure to make settings for options installed on the machine in the printer drivers.**

Reference

To make settings for options in the printer drivers, see *Printer Reference 1*.

❖ **Be sure to set the paper size and paper orientation in the printer driver when using duplex printing, combine (layout), staple and punch functions.**

Reference

For Information about duplex printing, booklet, and layout, see the printer driver Help.

To use the staple function, see p.48 “Staple” and the printer driver Help.

To use the punch function, see p.52 “Punch” and the printer driver Help.

Note

- Depending on the application, print settings may not be enabled and printed output may not be as expected.

❖ **When setting staple or collate in the printer driver, make sure that the Collate check box is cleared in the application's [Print] dialog box.**

If Collate is enabled in the application, printing will not be as intended.

Staple

































With the optional finisher installed, sets can be stapled individually when printing multiple sets.

Staple Position

The specified staple position varies depending on paper size, type, quantity and feed orientation. The following table shows staple positions:

Paper Orientation on the Machine	Print Data Direction	Staple Position	2 Tray Finisher	1,000-Sheet Finisher	Booklet Finisher
	R Vertical	Top Left Slant	R	X	R
		Top Right Slant	X	X	R
		Top Left	R	R	X
		Top Right	R	R	X
		2 at Top	X	X	X
		2 at Left	R	R	R
		2 at Right	R	R	R
		2 at Center	X	X	X
	R Horizontal	Top Left Slant	X	X	R
		Top Right Slant	R	X	R
		Top Left	R	R	X
		Top Right	R	R	X
		2 at Top	R	R	R
		2 at Left	X	X	X
		2 at Right	X	X	X
		2 at Center	X	X	X

X : means that the staple position is not supported.

Paper Orientation on the Machine	Print Data Direction	Staple Position	2 Tray Finisher	1,000-Sheet Finisher	Booklet Finisher
	Vertical 	Top Left Slant	×	×	
		Top Right Slant		×	 or 
		Top Left			×
		Top Right			 *1
		2 at Top			
		2 at Left	×	×	×
		2 at Right	×	×	×
		2 at Center	×	×	
	Horizontal 	Top Left Slant		×	 or 
		Top Right Slant	×	×	
		Top Left			 *1
		Top Right			×
		2 at Top	×	×	×
		2 at Left			
		2 at Right			
		2 at Center	×	×	

× : means that the staple position is not supported.

*1 : Available only PCL printer driver.

Reference

- For paper sizes and maximum numbers of sheets available for stapling, see “Specifications”, *General Settings Guide*.
- For printing methods, see the printer driver Help.
- The staple position will vary when using the PostScript 3 printer driver. For more information, see the PostScript 3 printer driver Help.







Stapling Precautions

Limitation

- Stapling can be done only with the optional finisher installed.
- Stapling cannot be done when paper is fed from the bypass tray.
- You cannot interrupt the current job with a job for another function requiring stapling or collating.

Note

- When the finisher is installed, and when an output tray that cannot output using the staple function has been selected, the paper will be output according to System Settings.
- If you cannot make staple settings even with the finisher installed, options may not be set correctly in the printer driver. Correct option settings in the printer driver. For details, see the printer driver Help.
- When duplex printing is selected, adjust staple positions to the binding orientation.
- When the finisher is being used for another function's job (for example, a copy job), printing will start after that job ends.
- When **[Top left slant]** or **[Top right slant]** is selected, the machine tries to staple at an angle. However, if slanted staple is mechanically impossible, the machine staples horizontally or vertically.
- When setting Staple in the printer driver settings, make sure that a collate option is not selected in the print settings of the application. If a collate option is selected in the application, printing will not be as intended.
- Be sure to set paper size and orientation in the printer driver when stapling.
 - Depending on the software you are using, print settings may not be saved and the printed result may not be as expected.
- When printing restarts after removing jammed paper, the printing position may be different, depending on the location of the jam.
 - If the paper jam occurred in the optional finisher, printing will restart from the top page of the data currently being printed, or from the page where the paper jam occurred.
 - If the paper jam occurred in the machine, printing will restart from the page where the paper jam occurred.
- Even if the paper jam occurred in the machine, the error will not be cleared unless the cover of the finisher is opened and closed.

















- ❑ Staple printing will be canceled under the following conditions:
 - If the number of staple jobs exceeds maximum. For information about the maximum number, see “Specifications”, *General Settings Guide*.
 - If a paper size that cannot be stapled is selected. For information about paper sizes that can be stapled, see “Specifications”, *General Settings Guide*.
 - If a paper type that cannot be stapled is selected.
The paper types that can be stapled are plain and recycled. Labels, thick paper and OHP transparencies cannot be stapled.
 - If positions other than those fixed for stapling are specified.
 - If there are inconsistencies between the orientation in duplex mode and the staple position.
 - If paper sizes are mixed when a different paper size is specified during a print job.
 - When staples have run out.
 - When feeding paper from the bypass tray.
 - When staples have run out and Auto Continue is set, printing will continue without stapling after the message has been displayed.
- ❑ When using the optional booklet finisher to select [**2 at Center**], the print job will be canceled if the staples run out.
- ❑ Paper sizes that can be stapled when using the Mixed Size mode are as follows:
 - A3  and A4 
 - B4  and B5 
 - 11" × 17"  and 8 1/2" × 11" 

Punch

With the optional finisher installed, holes can be punched into printed output.

Punch Position

The specified punch position varies depending on paper feed and print data orientation. The following table shows punch positions:

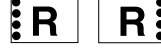
Paper Orientation on the Machine	Print Data Direction	Punch Position		
		2 Holes	3 Holes	4 Holes
	 Vertical			
	 Horizontal			
	 Vertical			
	 Horizontal			

 **Note**

Punch positions will vary slightly from page to page as holes are punched into each sheet individually.

 **Reference**

For information about paper sizes that can be punched, see “Specifications”, *General Settings Guide*.

For printing methods, see the printer driver Help.

The punch position will vary when using the PostScript 3 printer driver. For details, see the PostScript 3 printer driver Help.

Punching Precautions

Limitation

- Punching cannot be done when paper is fed from the bypass tray.

Note

- If you cannot make punch settings even with the finisher installed, options may not be set correctly in the printer driver. Correct option settings in the printer driver. For details, see the printer driver Help.
- When duplex printing is selected, adjust punch positions according to binding orientation.
- Be sure to set the punch position the same as the staple position when using it with the staple function.
- Be sure to set paper size and orientation in the printer driver when punching.
 - Depending on the software you are using, print settings may not be enabled and the printed result may not be as expected.
- Punch will be canceled under the following conditions:
 - When a paper size that cannot be punched is selected. For information about paper sizes that can be punched, see “Specifications”, *General Settings Guide*.
 - When a paper type that cannot be punched is selected. OHP transparencies cannot be punched.
 - If positions other than those fixed for punching are specified.
 - If there are inconsistencies between the orientation in duplex mode and the punch position.
 - When feeding paper from the bypass tray.
 - When the punch receptacle has become full and Auto Continue is set, printing will continue without punching after the message appears.

Collate

When printing multiple documents such as handouts for meetings, you can separate sets into order. This function is known as “Collate”. Collate stores data transmitted from a computer in memory. The following are the three types of collate:

❖ Collate

Printed output is assembled as sets in sequential order.

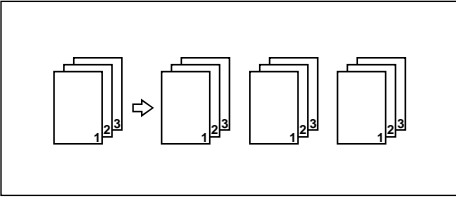

❖ Rotating Collate

Every other print set is rotated by 90 degrees .

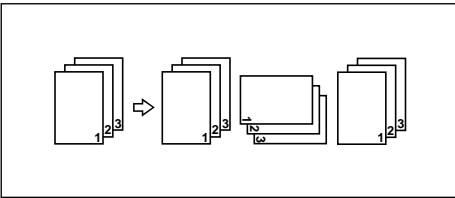

❖ Shift Collate

(The optional finisher is required for this function.)

The finisher shift tray moves backward or forward when a job or set is output, causing the next to shift, so you can separate them.

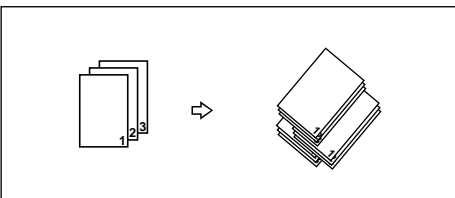

⚠ Limitation

- The optional finisher is required for Shift Collate.
- Rotating Collate is not possible when feeding paper from the bypass tray.
- Shift Collate is not possible when printing on 8 1/2" × 5 1/2" .
- If jobs containing pages of various sizes are set, Rotating Collate will not work.
- Rotating Collate, staple and punch functions cannot be combined.

 **Note**

- You can set Collate in the RPCS™ printer driver.
 - If you cannot make Shift Collate even with the optional finisher installed, options may not be set up correctly in the printer driver. Correct the printer driver's option settings. For details, see the printer driver Help.
- If Auto Continue occurs on the first set, Collate will be canceled.
- If forced printing occurs on the first set, Collate will be canceled.
- If a document with mixed paper sizes or sizes larger than A4, 8¹/₂ "× 11" is set, it can only be collated, even if Rotating Collate has been selected.
- When Cover/Slip Sheet or Chaptering has been selected, Collate or Shift Collate will occur even if Rotating Collate has been selected.
- When Rotating Collate has been selected, printing speed will be slower than with other collate functions.
- When setting Collate in the printer driver settings, make sure that a collate option is not selected in the application's print settings. If a collate option is selected, printing will not be as intended.

 **Reference**

For information about paper sizes and the number of sets you can use Collate, Rotating Collate, and Shift Collate with in every option, see *Copy Reference*.

For printing methods, see the printer driver Help.

Spool Printing

Spool Printing allows print jobs transferred from a computer to be temporarily stored, and then prints them after they are transferred. This shortens printing time as it maximizes printer efficiency.

Important

- During Spool Printing, the hard disk is accessed and the Data-In indicator blinks. Turning off the computer or machine during Spool Printing can damage the hard disk. Also, if the computer or machine is turned off during Spool Printing, spooled jobs will be deleted. Therefore, do not turn the power to the computer or machine off during Spool Printing.

Limitation

- If data is sent to the machine using other protocols besides LPR, IPP or SMB, Spool Printing cannot be performed.
- Up to a maximum of 150 jobs at once can be spool printed.

Note

- Printing the first page with Spool Printing will be slow.
- The computer requires less print processing time when large amounts of data are spooled.
- Stored spool jobs can be viewed or deleted using a Web browser.

Viewing/Deleting spool jobs in a Web browser

Start the Web browser and enter the machine's IP address in the address bar. This displays the top page.

Example : `http://192.168.155.160`

(In this example, the IP address of the machine is 192.168.155.160)

Click **[Administrator Mode]**, and then click **[Spool Printing Job List]** to display the spool jobs. To delete, check the box next to the name of the file you want to delete. Enter the password ^{*1}, and then click **[Delete]**. For more information, see *Network Guide*.

^{*1} The default password is "password".

 **Setting Spool Printing**

Spool Printing can be set using telnet or a Web browser.

- Using a Web browser
Click **[Configuration]**, and then click **[General]**. Set **[Spool Printing]** to **[Enable]**.
See *Network Guide* or Help for more information.
- Using telnet
Type in “spoolsw spool on” to set Spool Printing.
See *Network Guide* for more information about telnet.

Covers

Using this function, you can insert cover and back sheets fed from a different tray to that of the main paper, and print on them.



Reference

For printing methods, see the printer driver Help.

Limitation

To use this function, Collate must be set. Rotating Collate cannot be set.

Note

- The cover sheets should be the same size and orientation as the body of the paper.
- If Auto Tray Select is set as the paper feed tray for the body paper, the paper will be delivered from a tray containing paper in the  orientation. Therefore, if the cover paper is set to  orientation, the orientation of cover and body will be different.

Cover Sheet

Prints the first page of the document on the sheet for the cover page.

- Print on one side
 - Prints on one side of the cover sheet only, even when duplex printing is selected.

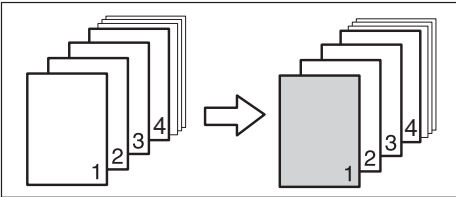

- Print on both sides
 - Prints on both sides of the cover sheet when duplex printing is selected.

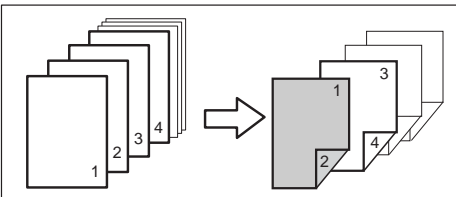

- Blank

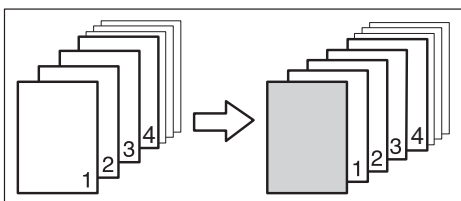

❖ Front/Back covers

Prints the first and last page of the document as the cover and back cover pages.

- Print on one side
Prints on one side of the cover sheets only, even when duplex printing is selected.

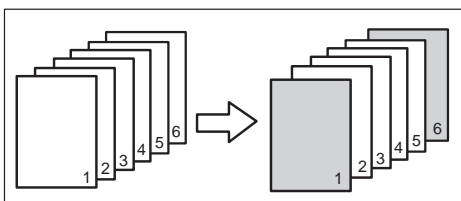

- Print on both sides
Prints on both sides of the cover sheets when duplex printing is selected.

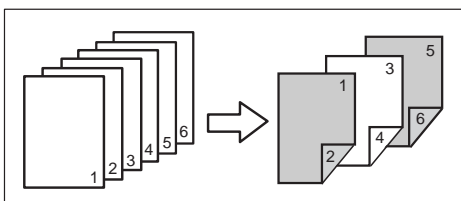

- Blank

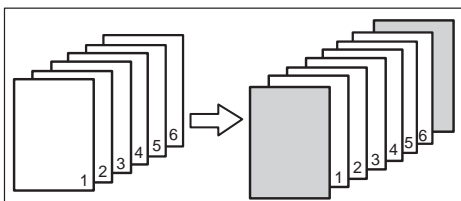

Slip Sheets

❖ Inserting a slip sheet between each page

- Print

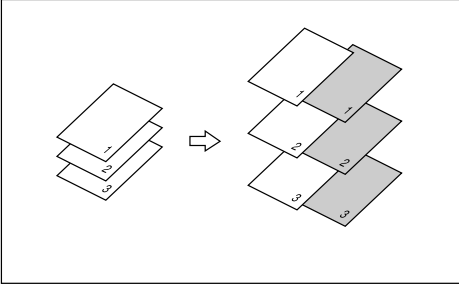

- Blank

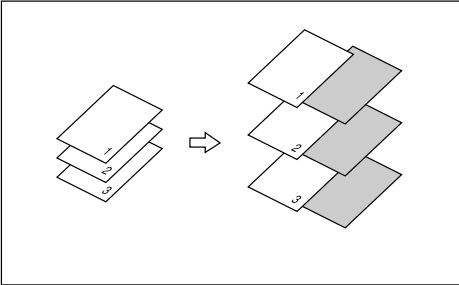

❖ Inserting a slip sheet between OHP transparencies

- Print

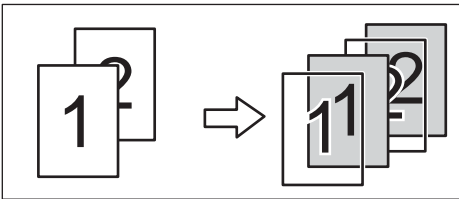

- Blank

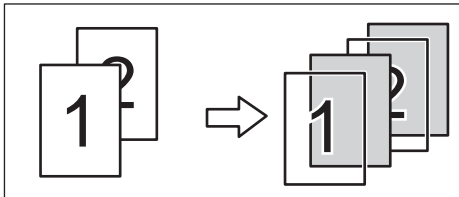

 **Note**

- Collate cannot be set when using slip sheets.
- Slip sheets cannot be inserted while duplex printing.
- The slip sheet should be the same size and orientation as the main paper.
- The same paper feed tray cannot be set for the main paper and slip sheets.

Chaptering

A specified page is printed on the same side as the first page, like a book. Also, you can insert slip sheets before specified pages, and select whether or not to print onto slip sheets.

📌 Limitation

- This function is available with the PCL and RPCS™ printer driver.

🔍 Reference

For printing methods, see the printer driver Help.

📝 Note

- Up to 20 pages can be specified as chapter front pages using the printer driver.

❖ No slip sheets

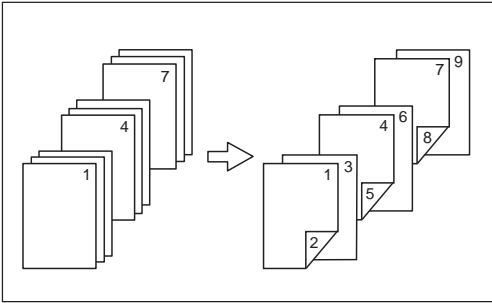

📝 Note

- This function is only valid with duplex printing.
- This function can be used together with combine (layout) printing.

❖ Inserting slip sheets

- Print

Prints on slip sheets. When duplex printing is selected, both sides of the slip sheets are printed onto.

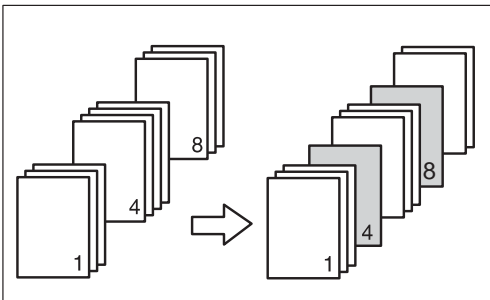

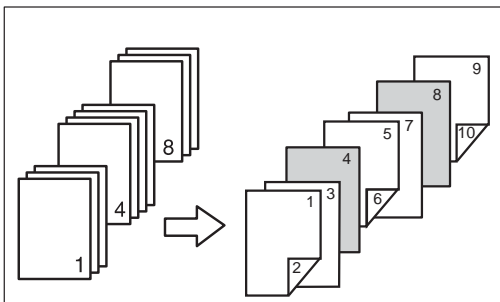

- **Print on front side only**
Prints on the front side of slip sheets even if duplex printing is selected.

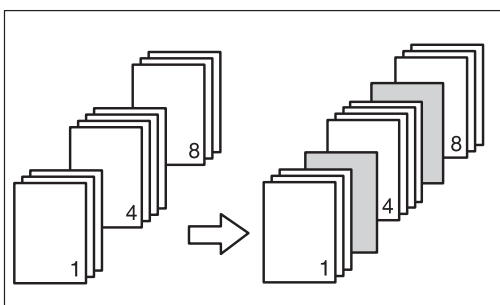

- **Blank**



 **Note**

- The slip sheet should be the same size and orientation as the main paper.
- If Auto Tray Select is set as the paper feed tray for the main paper, paper will be delivered from a tray containing paper in the  orientation. Therefore, if the cover paper is set to the  orientation, the orientation of the cover and body paper will be different.
- The same paper feed tray cannot be set for the body of the document and the slip sheet.

User Defined Pages

Using this function, you can specify the page numbers for each input tray.

Reference

For printing methods, see the printer driver Help.

Limitation

- This function is available with the PCL printer driver only.
- If **[Document Server]** is selected under **[Job Type]**, User Defined Page cannot be used.
- If **[User Defined Pages]** is selected under **[Paper]**, **[Layout:]** and **[Duplex:]** cannot be selected.

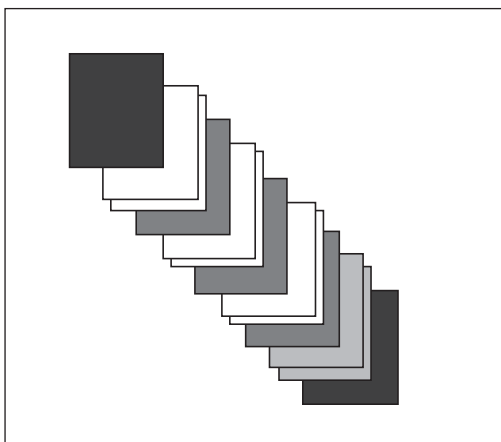

System Settings (Parallel Connection)

Interface Settings/Parallel Interface

❖ Parallel Timing

Specifies the timing for the parallel interface. Normally, you do not need to change this setting.

- ACK inside
- ACK outside
- STB down

Note

Default: *ACK outside*

❖ Parallel Communication Speed

Specifies the communication speed of the parallel interface. If the speed is too high, data may not be transferred smoothly. If this happens, change the setting to "Standard".

- High speed
- Standard

Note

Default: *High speed*

❖ Selection Signal Status

Specifies the signal level of the parallel interface.

- High
- Low

Note

Default: *High*

❖ Input Prime

Specifies whether the prime signal is active or inactive when an input prime signal is sent. Normally, you do not need to change this setting.

- Effective
- Invalid

Note

Default: *Invalid*

❖ Bidirectional Communication

Specifies, for instance, how a printer connected to the parallel interface responds to a status request. If you experience problems using another manufacturer's printer, set this to OFF.

Limitation

If set to OFF, asynchronous communication will not work.

- ON
- OFF

Note

Default: *ON*

❖ Signal Control

Specifies how to handle any errors that occur when printing from a computer or sending faxes. Normally, you do not need to change this setting.





- Job acceptance priority
- Printer priority
- Facsimile priority

Note

Default: *Job acceptance priority*

Specifications

This section contains the machine's electrical and hardware specifications, including information about its options.

Component	Specifications
Resolution	PCL 6 : 600 dpi PCL 5e: 300 dpi, 600 dpi RPCS™ : 200 dpi, 300 dpi, 600 dpi PostScript 3 : 300 dpi, 600 dpi
Printing speed	35 ppm/45 ppm (A4  , 8½" × 11"  plain paper)  Note <input type="checkbox"/> Printing speeds depend on the machine. Check which type of machine you have. See <i>General Settings Guide</i> .
Interface	Standard: <ul style="list-style-type: none"> IEEE 1284 parallel interface  Note <input type="checkbox"/> Use a standard 36-pin printer cable not longer than 3 meters (10 feet). <ul style="list-style-type: none"> Ethernet interface (100BASE-TX/10BASE-T) Option: <ul style="list-style-type: none"> IEEE 1394 interface IEEE 802.11b wireless LAN interface USB 2.0 interface Bluetooth™ interface
Network protocol	TCP/IP, IPX/SPX, NetBEUI *1, AppleTalk
Printer language	Standard: PCL 6, PCL 5e, RPCS™ Option: PostScript 3
Fonts	PCL 6/5e : Afga Monotype Font Manager 35 Intellifonts, 10 TrueType fonts, and 1 Bitmap font Font Manager available. PostScript 3 : 136 fonts (Type 2:24, Type 14:112)
Memory	192 MB
Hard disk	Storage capacity : 20 GB

Component	Specifications
Operating systems supported by this machine	Windows 95/98/Me Windows 2000 Windows XP Windows NT 4.0 Mac OS 8.6 to 9.2 Mac OS X
Network cable	100BASE-TX/10BASE-T shielded twisted-pair (STP, Category/Type5) cable.

*1 To use NetBEUI, use the SmartNetMonitor port.

Options

Limitation

- Only one optional interface board can be installed in the machine at a time. Therefore, the optional IEEE 1394 interface board, the optional 802.11b interface kit (wireless LAN board) and the optional USB 2.0 interface board cannot be installed concurrently.

IEEE 1394 Interface Board type 4510

❖ Transmission spec.:

IEEE 1394

❖ Interface:

IEEE std 1394-1995 compliant
IEEE std 1394a-2000 compliant

❖ Device class:

SCSI print (Windows 2000, Windows XP)
IP over 1394 (Windows Me, Windows XP)

❖ Protocol:

SBP-2 (SCSI print)
TCP/IP (IP over 1394)

❖ Interface connector:

IEEE 1394 (6 pin × 2)

❖ Required cable:

1394 interface cable (6 pin × 4 pin, 6 pin × 6 pin)

Important

- You cannot plug devices together to create loops.
- Do not use cable that is more than 4.5 meters in length.

- ❖ **Data transfer speed:**
Maximum 400 Mbps
- ❖ **Connectable number of devices on a bus:**
Maximum 63
- ❖ **Allowed cable hops on a bus:**
Maximum 16
- ❖ **Power supply:**
Non external power supply
Cable Power repeated (IEEE 1394a-2000 compliant)

IEEE 802.11b Interface Kit Type B

- ❖ **Transmission spec.:**
Based on IEEE 802.11b (wireless LAN)
- ❖ **Protocol:**
TCP/IP, NetBEUI, IPX/SPX, AppleTalk

**Note**

- SmartNetMonitor and Web browser are supported.

- ❖ **Data transfer speed:**
Auto select from below speed
1Mbps, 2Mbps, 5.5Mbps, 11Mbps
- ❖ **Frequency range:**
 - Inch version:
2400-2497 MHz (1-11 channels)
 - Metric version:
2400-2497 MHz (1-13 channels)

- ❖ **Transmittable distance:**

1Mbps 400 m ^{*1}
2Mbps 270 m ^{*1}
5.5Mbps 200 m ^{*1}
11Mbps 140 m ^{*1}

^{*1} These figures are a guideline for outdoor use. In general, the transmittable distance indoors is 10-100 m, depending on environment.

- ❖ **Transmission mode:**
802.11 ad hoc, ad hoc, and infrastructure mode

USB2.0 Interface Board Type A

❖ **Transmission spec:**

Based on USB 2.0

❖ **Data transfer speed:**

High Speed: 480 Mbps

Full Speed: 12 Mbps

❖ **Supported operating system:**

Windows 98 SE/Me, Windows 2000/XP, Mac OS 9.x, Mac OS X Classic

 **Note**

- This USB 2.0 interface board is compatible with devices that support USB 1.1.
- For Windows 98 SE/Me, be sure to install USB Printing Support included on the CD-ROM that comes with this machine. When USB 2.0 is used under Windows 98 SE/Me, only a speed equal to that of USB 1.1 is possible.
- Macintosh supports only the standard USB 1.1 port.

PostScript 3 Unit Type 2045

 **Reference**

PostScript 3 Unit Type 2045 Operating Instructions Supplement

BlueTooth Unit Type 2045

This Bluetooth interface unit does not support BIP.

 **Reference**

See the manual that comes with optional Bluetooth interface unit.

INDEX

C

- Canceling a job
 - Macintosh*, 11
 - Windows*, 10
- Chaptering, 62
- Collate, 54
- Configuration page, 38
- Control panel
 - locked print*, 15
 - printer features, adjusting*, 35
 - sample print*, 15
- Covers, 58

D

- Data In indicator, 30, 32, 33
- Display panel
 - error messages*, 23
- Document Server, 13

E

- Error messages, 23

F

- Finisher, 47
- Fonts, 66

H

- Hard disk, 66
- Host Interface, 44

I

- IEEE 1394 Interface Board type 4510, 67
- IEEE 802.11b Interface Kit Type B, 68
- Interface, 66

L

- List/Test Print, 38
- Locked print, 18
 - deleting*, 19

M

- Macintosh
 - canceling a job*, 11
 - setting up, printer driver*, 9
- Maintenance, 41
- Memory, 66

N

- Network Cable, 67
- Network protocol, 66

O

- Operating system, 67
- Options, 67

P

- Paper Input, 38
- PCL menu, 45
- PostScript 3 Unit Type 2045, 69
- Printer driver
 - Printer properties, Windows 2000/XP*, 6
 - Printer properties, Windows 95/98/Me*, 5
 - Printer properties, Windows NT 4.0*, 7
 - setting up, Macintosh*, 9
- Printer features
 - adjusting*, 37
 - menu*, 35
 - parameters*, 38
- Printer Language, 66
- Printing speed, 66
- Punch, 52

R

- Resolution, 66

S

- Sample print, 15
 - deleting*, 17
- Slip Sheets, 60
- Specifications, 66
- Spool printing, 56
- Staple, 48
- System, 42

T

- Troubleshooting, 23
 - error messages*, 23
 - machine does not print*, 28
 - other printing problems*, 31
 - status messages*, 23

U

- USB2.0 Interface Board Type A, 69

W

- Windows
 - canceling a job*, 10
- Windows 2000/XP
 - printer properties, printer driver*, 6
- Windows 95/98/Me
 - printer properties, printer driver*, 5
- Windows NT 4.0
 - printer properties, printer driver*, 7



Printer/Scanner Unit Type 2045e

Operating Instructions Scanner Reference



-
- 1 Network Scanner
 - 2 Preparations for Use as a Network Scanner
 - 3 Setting Originals
 - 4 Sending Scan File by E-mail
 - 5 Sending Scan File by Scan to Folder
 - 6 Using the Document Server Function
 - 7 Using the Network Delivery Scanner Function
 - 8 Using the Network TWAIN Scanner Function
 - 9 Appendix

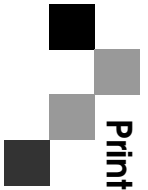

Printer/Scanner Unit Type 2045e Operating Instructions Scanner Reference

Introduction

This manual describes detailed instructions on the operation and notes about the use of this machine. To get maximum versatility from this machine all operators are requested to read this manual carefully and follow the instructions. Please keep this manual in a handy place near the machine.

Scanner function is available when Printer/Scanner option is installed to your machine.

Warning:

Use of controls or adjustment or performance of procedures other than those specified in this manual might result in hazardous radiation exposure.

Two kinds of size notation are employed in this manual. With this machine refer to the inch version.

Trademarks

Adobe and Acrobat are trademarks of Adobe Systems Incorporated.

Ethernet is a registered trademark of Fuji Xerox Corporation.

Pentium is a registered trademark of Intel Corporation.

MS, Microsoft and Windows are registered trademarks of Microsoft Corporation.

Other product names used herein are for identification purposes only and might be trademarks of their respective companies. We disclaim any and all right in those marks.

- The product name of Windows[®]95 is Microsoft[®] Windows[®] 95.
- The product name of Windows[®]98 is Microsoft[®] Windows[®] 98.
- The product name of Windows[®] Me is Microsoft[®] Windows[®] Millennium Edition (Windows Me).
- The product names of Windows XP are as follows:
Microsoft[®] Windows[®] XP Professional
Microsoft[®] Windows[®] XP Home Edition
- The product names of Windows[®] 2000 are as follows.
Microsoft[®] Windows[®] 2000 Professional
Microsoft[®] Windows[®] 2000 Server
- The product names of Windows Server[™] 2003 are as follows:
Microsoft[®] Windows Server[™] 2003 Standard Edition
Microsoft[®] Windows Server[™] 2003 Enterprise Edition
Microsoft[®] Windows Server[™] 2003 Web Edition
- The product names of Windows NT[®] are as follows.
Microsoft[®] Windows NT[®] Server 4.0
Microsoft[®] Windows NT[®] Workstation 4.0

In accordance with IEC 60417, this machine uses the following symbols for the main power switch:

I means **POWER ON.**

⏻ means **STAND BY.**

Note to users in the United States of America

Notice:

This equipment has been tested and found to comply with the limits for a Class B digital device, pursuant to Part 15 of the FCC Rules. These limits are designed to provide reasonable protection against harmful interference in a residential installation. This equipment generates, uses and can radiate radio frequency energy and, if not installed and used in accordance with the instructions, may cause harmful interference to radio communications. However, there is no guarantee that interference will not occur in a particular installation. If this equipment does cause harmful interference to radio or television reception, which can be determined by turning the equipment off and on, the user is encouraged to try to correct the interference by one more of the following measures:

Reorient or relocate the receiving antenna.

Increase the separation between the equipment and receiver.

Connect the equipment into an outlet on a circuit different from that to which the receiver is connected.

Consult the dealer or an experienced radio /TV technician for help.

Warning

Changes or modifications not expressly approved by the party responsible for compliance could void the user's authority to operate the equipment.

Note to users in Canada

Warning:

This Class B digital apparatus complies with Canadian ICES-003.

Remarque concernant les utilisateurs au Canada

Avertissement:

Cet appareil numérique de la classe B est conforme à la norme NMB-003 du Canada.

Caution (in case of 100BASE-TX environment):

Network interface cable with ferrite core must be used for RF interference suppression.

Declaration of Conformity

Product Name: Printer/Scanner Controller

Model Number: Printer/Scanner Unit Type 2045e

Responsible party: Ricoh Corporation

Address: 5 Dedrick Place, West Caldwell, NJ 07006

Telephone number: 973-882-2000

This device complies with part 15 of FCC Rules.

Operation is subject to the following two conditions:

1. This device may not cause harmful interference, and
2. this device must accept any interference received, including interference that may cause undesired operation.

Manuals for This Machine

The following manuals describe the operational procedures of this machine. For particular functions, see the relevant parts of the manual.

Note

- r The manuals provided are specific to machine type.
- r Adobe Acrobat Reader is necessary to view the PDF file manuals.
- r Two CD-ROMs are provided:
 - CD-ROM 1 "Operating Instructions for Printer / Scanner"
 - CD-ROM 2 "Scanner Driver & Document Management Utilities"

v **General Settings Guide**

Provides an overview of the machine and describes System Settings (paper trays, Key Operator Tools, etc.), Document Server functions, and troubleshooting.

Refer to this manual for Address Book procedures such as registering fax numbers, e-mail addresses, and user codes.

v **Network Guide (PDF file - CD-ROM1)**

Describes procedures for configuring the machine and computers in a network environment.

v **Copy Reference**

Describes operations, functions, and troubleshooting for the machine's copier function.

v **Facsimile Reference <Basic Features>**

Describes operations, functions, and troubleshooting for the machine's facsimile function.

v **Facsimile Reference <Advanced Features>**

Describes advanced functions and settings for key operators.

v **Printer Reference 1**

Describes system settings and operations for the machine's printer function.

v **Printer Reference 2 (PDF file - CD-ROM1)**

Describes operations, functions, and troubleshooting for the machine's printer function.

v **Scanner Reference (this manual) (PDF file - CD-ROM1)**

Describes operations, functions, and troubleshooting for the machine's scanner function.

v **Manuals for DeskTopBinder V2 Lite**

DeskTopBinder V2 Lite is a utility included on the CD-ROM labeled "Scanner Driver & Document Management Utilities".

- DeskTopBinder V2 Lite Setup Guide (PDF file - CD-ROM2)
Describes the installation of DeskTopBinder V2 Lite, and the operating environment for DeskTopBinder V2 Lite in detail. This guide can be displayed from the **[Setup]** dialog box when DeskTopBinder V2 Lite is installed.
- DeskTopBinder V2 Lite Introduction Guide (PDF file - CD-ROM2)
Describes operations with DeskTopBinder V2 Lite and provides an overview of its functions. This guide is added to the **[Start]** menu when DeskTopBinder V2 Lite is installed.
- Auto Document Link Guide (PDF file - CD-ROM2)
Describes operations and functions of Auto Document Link installed with DeskTopBinder V2 Lite. This guide is added to the **[Start]** menu when DeskTopBinder V2 Lite is installed.

v **Manuals for ScanRouter V2 Lite**

ScanRouter V2 Lite is a utility included on the CD-ROM labeled "Scanner Driver & Document Management Utilities".

- ScanRouter V2 Lite Setup Guide (PDF file - CD-ROM2)
Describes the installation of ScanRouter V2 Lite, settings, and the operating environment for ScanRouter V2 Lite in detail. This guide can be displayed from the **[Setup]** dialog box when ScanRouter V2 Lite is installed.
- ScanRouter V2 Lite Management Guide (PDF file - CD-ROM2)
Describes delivery server management and operations, and provides an overview of ScanRouter V2 Lite functions. This guide is added to the **[Start]** menu when ScanRouter V2 Lite is installed.

v **Other manuals**

- PS3 Supplement (PDF file - CD-ROM1)
- UNIX Supplement (available from an authorized dealer or as a PDF file on our Web site)

TABLE OF CONTENTS

Manuals for This Machine	i
How to Read This Manual	1
Symbols	1
Names of Major Options	1

1. Network Scanner

Outline	3
E-mail	3
Scan to Folder.....	4
Document Server	5
Network Delivery Scanner.....	6
Network TWAIN Scanner	7
Control Panel	8
Display Contents	10

2. Preparations for Use as a Network Scanner

Initial Scanner Setup	13
Scanner Features.....	13
Scan Settings	16
Destination List Settings.....	20
Send Settings.....	21
Programs	23
Storing a Program	23
Recalling a Program.....	24
Changing a Stored Program	24
Deleting a Program	24
Changing the program name	24
Installing Software	25
Auto Run Program	25
Software for Using a Network TWAIN Scanner	27
Software for Using the Network Delivery Scanner Function	28
DeskTopBinder V2 Lite	29
Software Supplied on CD-ROM	29

3. Setting Originals

Placing Originals	35
Placing on the Exposure Glass	36
Placing in the Auto Document Feeder	37
Original Orientation and Scan Area	39
For E-mail, Scan to Folder, and a Network Delivery Scanner.....	40
For a Network TWAIN Scanner.....	41
Scanning Originals in Several Times	42

4. Sending Scan File by E-mail

Preparation for Sending by E-mail	45
E-mail Screen.....	46
Sending Scan File by E-mail	47
Procedure for Sending E-mail.....	47
Simultaneous Storage and Sending by E-mail.....	57
Checking the Status of E-mail	58

5. Sending Scan File by Scan to Folder

Preparation for Sending by Scan to Folder	59
Scan to Folder Screen	60
Sending Scan File by Scan to Folder	61
Procedure for Sending by Scan to Folder	61
Simultaneous Storage and Sending by Scan to Folder	70
Checking the Status of Scan to Folder	71

6. Using the Document Server Function

Storing Files	73
Storage Procedure	74
Viewing a List of Stored Files	77
Viewing the List.....	78
Searching for Files	80
Sending Stored Files by E-mail or Scan to Folder, or Delivering	81
Managing Stored Files.....	82
Deleting Files	82
Changing File Information	83

7. Using the Network Delivery Scanner Function

Preparation for Delivering.....	85
Network Delivery Scanner Screen	86
Delivering Scan File.....	87
Delivery Procedure.....	87
Simultaneous Storage and Delivery.....	93
Checking the Status of Delivery	94

8. Using the Network TWAIN Scanner Function

Preparation for Using the Network TWAIN Scanner.....	95
Scanning Originals	96
Functions of the TWAIN Driver	98

9. Appendix

Relationship between Resolution and File Size.....	99
When Using as E-mail, Scan to Folder, Document Server or Network Delivery Scanner...	99
When Using as a Network TWAIN Scanner.....	100
Relationship between File Type Specified and File Type Used When Sending E-mail...	102
Max. Number of Addresses Which Can Be Specified and Files Which Can Be Stored ...	103
Troubleshooting.....	104
When Scanning Is Not Performed as Expected.....	104
When the Delivery Function Does Not Work.....	104
When Stored Files Cannot Be Accessed	104
When an Error Message Appears on the Control Panel	105
When an Error Message Appears on the Client Computer	110
Specifications.....	113
INDEX.....	114

How to Read This Manual

Symbols

In this manual, the following symbols are used:

Important

If this instruction is not followed, paper might be misfed, originals might be damaged, or files might be lost. Be sure to read this.

Preparation

This symbol indicates the prior knowledge or preparations required before operating.

Note

This symbol indicates precautions for operation or actions to take after misoperation.

Limitation

This symbol indicates numerical limits, functions that cannot be used together, or conditions in which a particular function cannot be used.

Reference

This symbol indicates a reference.

[]

Keys that appear on the machine's display panel.

[]

Keys and buttons that appear on the computer's display.

[]

Keys built into the machine's control panel.

[]

Keys on the computer's keyboard.

Names of Major Options

Major options of this machine are referred to as follows in this manual:

- Printer/Scanner Unit Type 2045e → printer/scanner controller

The following software products are referred to using a general name:

- DeskTopBinder V2 Lite and DeskTopBinder V2 Professional → DeskTopBinder V2 Lite/Professional
- ScanRouter V2 Lite and ScanRouter V2 Professional (optional) → ScanRouter V2 Lite/Professional

1. Network Scanner

Outline

By installing the printer/scanner controller, the machine can be used as a network scanner.

As a network scanner, the machine can send e-mail, send files to the FTP server or the shared folders of client computers, store scan files in the Document Server, operate as a network delivery scanner, and operate as a network TWAIN scanner.

E-mail

Scan file that is attached to an e-mail can be sent using the e-mail system through a LAN or the Internet.

Reference

p.45 "Sending Scan File by E-mail"

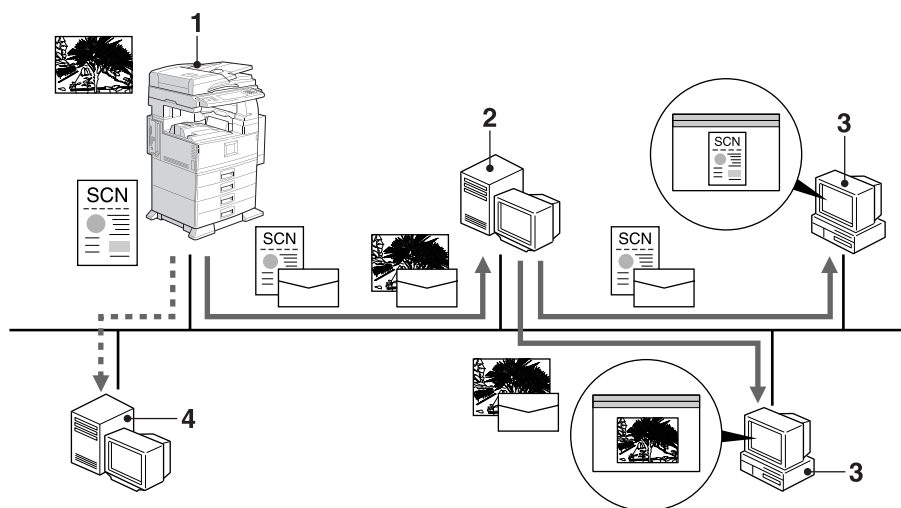

1. This machine

Scan file that is attached to an e-mail can be sent to an e-mail server. In combination with the file storage function, scan files from multiple originals that have been temporarily stored can be sent all at once.

2. E-mail server

An e-mail server is the SMTP server used for an e-mail system. It transfers a received e-mail to a specified destination through a LAN or the Internet.

3. Client computer

An e-mail with scan file attached is received from the e-mail server using e-mail software.

Check the content of the file using an application appropriate for the file type.

4. LDAP server

LDAP server provides a directory service corresponding to the inquiry or reference operation from the client computer on the same network.

E-mail address information can be searched for from the machine when you use LDAP server as a data base of the user authentication and the e-mail account management.

Scan to Folder

Scan file can be sent to the folders of the FTP server or the shared folders of Windows on the same network.

Reference

p.59 "Sending Scan File by Scan to Folder"

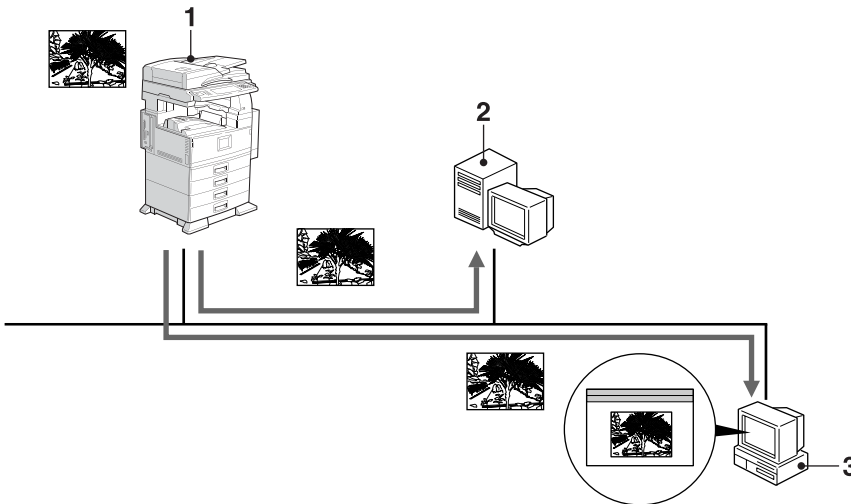

1. This machine

Scan file can be sent to the folders of the FTP server using FTP protocol or the shared folders of Windows using SMB protocol. In combination with the file storage function, scan files from multiple originals that have been temporarily stored can be sent all at once.

2. FTP server

The FTP server is a server that provides file transfer services among client computers on the same network. Scan file that is sent to the FTP server can be stored, and the stored file can be downloaded by a client computer that logs onto the FTP server.

3. Client computer

Scan file that is sent from the machine is received in the shared folders of Windows.

Check the content of the file using an application appropriate for the file type.

Document Server

Scan file from the originals is stored as a file on the hard disk of the machine and can be viewed, copied, deleted, or retrieving using DeskTopBinder V2 Lite/Professional from a client computer via a network. A file can be searched for using the user name or the file name. Also, others can be kept from viewing a file by setting a password for the file.

Reference

p.73 "Using the Document Server Function"

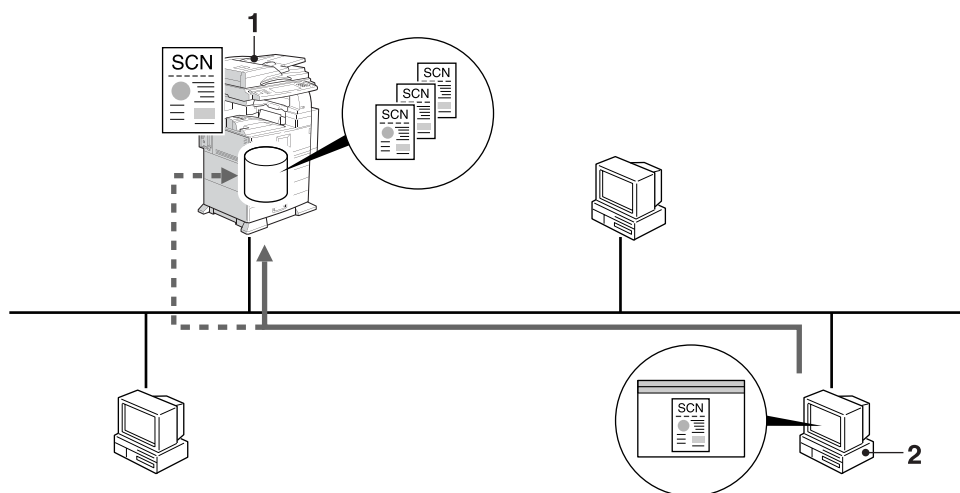

1. This machine

Scan file from the originals scanned by the scanner is stored.

2. Client computer

A stored file can be viewed, copied, or deleted by connecting to the machine using DeskTopBinder V2 Lite/Professional.

Also, a file stored in the machine using a Web browser can be viewed, downloaded or deleted.

Reference

For more information about DeskTopBinder V2 Lite, see the DeskTopBinder V2 Lite manuals. See p.i "Manuals for This Machine".

Network Delivery Scanner

The machine is used as a delivery scanner with ScanRouter V2 Lite/Professional. Scan file from the originals scanned by the machine is stored in the delivery server and delivered to the folders of client computers on the same network.

Reference

p.85 "Using the Network Delivery Scanner Function"

Note

When the optional ScanRouter V2 Professional is used, the machine can also deliver scan file using e-mail, and the file can be viewed from a client computer using a Web browser.

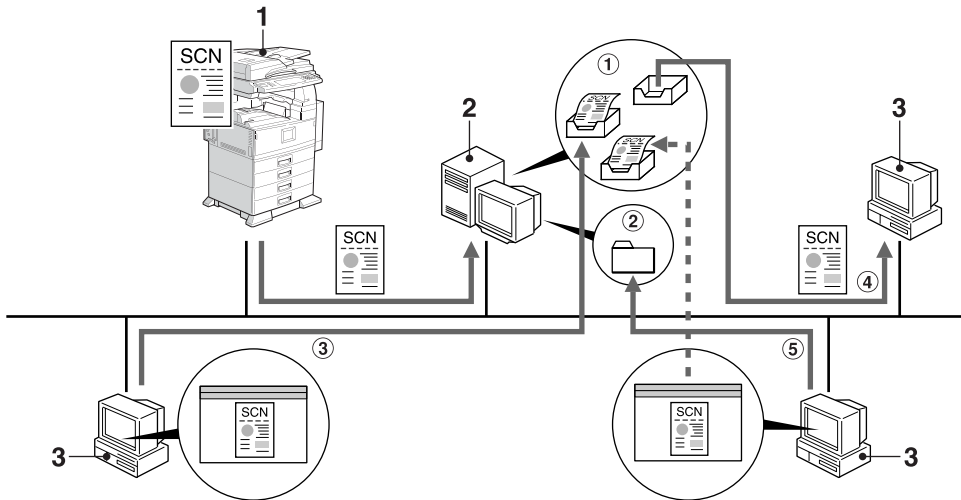

1. This machine

Scan file from the originals scanned by the scanner is sent to the delivery server. In combination with the file storage function, scan files from multiple originals that have been temporarily stored can be delivered all at once.

2. Delivery server

ScanRouter V2 Lite/Professional is installed in this computer which is used as a delivery server.

Received file is delivered to the in-tray of the specified destination (① in the figure). According to the settings of the in-tray, the file is stored in the in-tray or in a Windows folder (② in the figure).

3. Client computer

The contents of stored file can be checked in the following ways:

- View the file in the in-tray using DesktopBinder V2 Lite to check the contents. (③ in the figure)
- Use Auto Document Link to receive the file stored in the in-tray, and check the contents with an application corresponding to the file format. (④ in the figure)
- Access the Windows folder where the file is stored via the network, and check the contents with an application corresponding to the file format. (⑤ in the figure)

Reference

For more information about ScanRouter V2 Lite, DeskTopBinder V2 Lite, or Auto Document Link, see the respective documentation. See p.i “Manuals for This Machine”.

1

Network TWAIN Scanner

The scanning function of this machine can be used from a client computer via a network (Ethernet, IEEE 1394 (IP over 1394) [optional], or IEEE 802.11b (Wireless LAN) [optional]). Originals can be scanned with the same operation used for SCSI- and USB-connected scanners.

Reference

p.95 “Using the Network TWAIN Scanner Function”

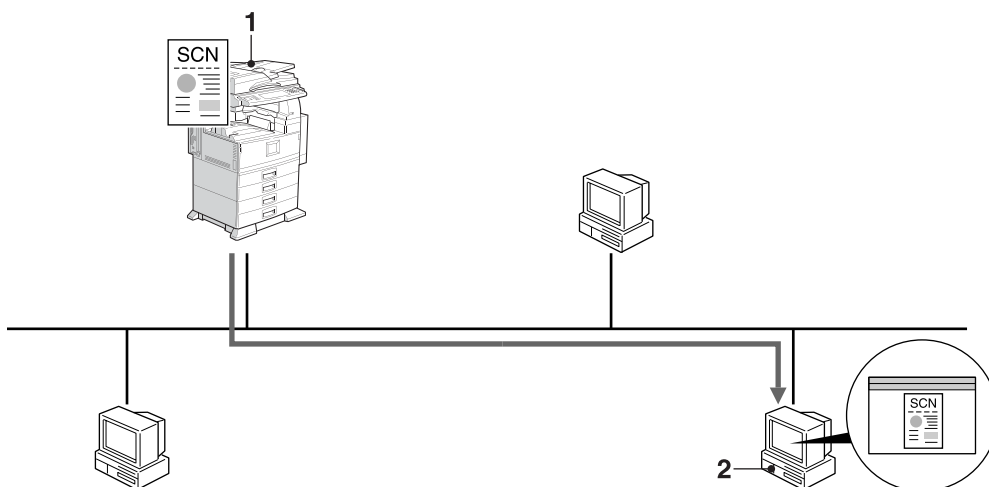

1. This machine

The scanning function of the machine can be used from a client computer via a network.

2. Client computer

Originals are scanned using the TWAIN driver for the machine from an application.

Control Panel

This illustration shows the control panel when options are installed.

1

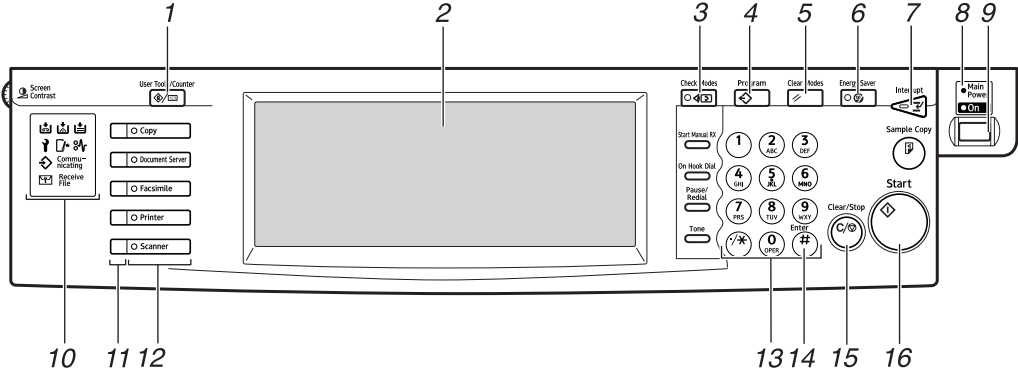

1. [User Tools/Counter] key

Use to change default or operation parameters according to the operating conditions.

2. Display panel

Displays the operation status and messages.

3. [Check Modes] key

Press to check the destinations which are currently selected.

4. [Program] key

Use to register settings used frequently as a program or to recall the registered program.

5. [Clear Modes] key

Press to clear the current settings.

6. [Energy Saver] key

Press this key to begin warm-up.

Pressing this key again while in warm-up mode cancels warm-up.

Note

This key is inactive while scanning or setting scanner defaults.

7. [Interrupt] key

Press this key to interrupt the scanner mode and to activate the copy mode.

8. Main power indicator and power indicator

The main power indicator lights up when the main power switch is set to on. The power indicator lights up when the machine is on.

Important

Do not turn off the main power while the power indicator is lit or blinking. Doing so may cause a failure of the hard disk.

9. Operation switch

Press this switch to turn the machine on. The power indicator lights up. To turn the machine off, press this switch again.

Note

This key is inactive while scanning or setting scanner defaults.

10. Indicators

Display errors and the machine status.

: Add Staple indicator

: Add Toner indicator

: Add Paper indicator

: Service Call indicator

: Open Cover indicator

: Misfeed indicator

Reference

For more information, see *General Settings Guide*.

11. Function status indicators

- When lit green, the corresponding function is active.
- When lit red, the corresponding function is interrupted. Press the respective key, and then follow the instructions that appear on the screen.

12. Function keys

Press the **[Copy]**, **[Document Server]**, **[Facsimile]**, **[Printer]**, or **[Scanner]** key to activate the respective function. The display content changes accordingly.

The indicator for the selected function lights up.

13. Number keys

Use to enter numeric values.

14. **[#]** key (Enter key)

Use to enter a numeric value.

15. **[Clear/Stop]** key

- Clear: Clears an entered numeric value
- Stop: Stops scanning

16. **[Start]** key

Use to begin scanning, file storing, or delivery.

Display Contents

This section explains the normal screen configuration.

The display's contents differ depending on the function.

Note

- The Copy screen is set as the default screen when the machine is turned on. You can change this setting in the System Settings. See *General Settings Guide*.

Using e-mail

Press the **[Scanner]** key to display the e-mail screen (when **[E-mail/ Folder]** has been selected in **[Destination List Display Priority 1]** and **[E-mail Address]** has been selected in **[Destination List Display Priority 2]**). If the Network TWAIN Scanner screen appears, press **[Exit]**.



Reference

For information about Destination List Display Priority, see p.20 "Destination List Settings".

Using Scan to Folder

Press the **[Scanner]** key to display the Scan to Folder screen (When **[E-mail/ Folder]** has been selected in **[Destination List Display Priority 1]** and **[Folder]** has been selected in **[Destination List Display Priority 2]**). If the Network TWAIN Scanner screen appears, press **[Exit]**.



For information about Destination List Display Priority, see p.20 "Destination List Settings".

2. Preparations for Use as a Network Scanner

To use the machine as a network scanner, you must make settings required for use as a scanner as well as basic settings for use in a network.

Reference

First, see *General Settings Guide* for details about how to make basic settings, and then make scanner settings.

For more information about settings for sending by e-mail, see *Network Guide*.

Initial Scanner Setup

This section explains all required settings and procedures for using the machine as a network scanner.

Scanner Features

The settings for using the network scanner functions of the machine are listed below. Make the necessary settings.

Note

r Making settings for the items marked with m if necessary.

v Scan Settings

For explanations of settings, see p.16 “Scan Settings”.

Settings		Default	E-mail	Scan to Folder	Store	Delivery	TWAIN
Default Scan Settings	Scan Type	Text (Print)	m	m	m	m	
	Resolution	200 dpi	m	m	m	m	
	Image Density	Auto Image Density (Medium)	m	m	m	m	
	Scan Size	Auto Detect	m	m	m	m	
Wait Time for Next Orig.: Exposure Glass	Set Wait Time (60)	m	m	m	m		
Wait Time for Next Original(s): SADF	Set Wait Time (60)	m	m	m	m		
Original Setting	1 sided original	m	m	m	m		
Original Feed Type Priority	Off	m	m	m	m		
Mixed Original Sizes Priority	Off	m	m	m	m		

Settings	Default	E-mail	Scan to Folder	Store	Delivery	TWAIN
Original Orientation Priority		m	m	m	m	
Change Initial Mode	Standard	m	m	m	m	

v Destination List Settings

For explanations of settings, see p.20 “Destination List Settings”.

Settings	Default	E-mail	Scan to Folder	Store	Delivery	TWAIN
Destination List Display Priority 1	Delivery Server	m	m		m	
Destination List Display Priority 2	E-mail Address	m	m			
Select Title	Title 1	m	m		m	
Update Delivery Server Destination List	-				m	

Note

r **[Destination List Display Priority 1]** and **[Update Delivery Server Destination List]** will not be displayed when **[OFF]** is selected for **[Delivery Option]** in **[File Transfer]** of System Settings. See *Network Guide*.

v Send Settings

For explanations of settings, see p.21 “Send Settings”.

Settings	Default	E-mail	Scan to Folder	Store	Delivery	TWAIN
TWAIN Standby Time	10 sec.	m	m	m	m	m
File Type Priority	Multi-page: TIFF	m	m			
Compression (Black & White)	On	m	m	m	m	
Compression (Gray Scale)	Standard	m	m	m	m	
Print & Delete Scanner Journal	Delete All after Printing	m	m		m	
Max. E-mail Size	2048KB	m				
Divide & Send E-mail	Yes (per max. size)	m				
E-mail Information Language	American English	m				
Sender's Name Default	No	m				

Scan Settings

This section explains how to set the defaults for scan settings.

The scan settings consist of the following. For the list about settings and defaults, see p.13 “Scanner Features”.















v Default Scan Settings

Various basic settings (scan type, resolution, image density, scan size) can be set.

- Scan Type
Select the scan type from the following:
 - Text (Print)
For standard originals containing mainly text (for print)
 - Text (OCR)
For standard originals containing mainly text (for OCR)
 - Text/ Photo
For originals containing a mixture of text and photographs
 - Photo
For originals containing photographs and other pictures (two-value)
 - Gray Scale
For originals containing photographs and other pictures (multi-value)

Note

- r Printer printing is best scanned with Text (Print). Text (OCR) is suitable for higher OCR accuracy.
- r An image is scanned in black & white with Photo, and in gray-scale with Gray Scale. As a general rule, scanning for the purpose of printing is best done with Photo and scanning for viewing on the computer screen with Gray Scale.

- Resolution
Select the resolution from 100 dpi, 200 dpi, 300 dpi, 400 dpi, or 600 dpi.
- Image Density
Select the image density in seven steps from Lighter (1) to Darker (7) or use Auto Image Density.
- Scan Size
Select the size of the original to be scanned.
When **[Auto Detect]** is selected, the auto detect function of the machine is used to set the original size.
When the size is specified, scanning is performed for that size, regardless of the actual size of the original. The following sizes can be selected:
A3 , A4 , A4 , A5 , A5 , 11 x 17 , 8¹/₂ x 14 , 8¹/₂ x 13 , 8¹/₂ x 11 , 8¹/₂ x 11 , 5¹/₂ x 8¹/₂ , 5¹/₂ x 8¹/₂ , B4 JIS  (Japanese Industrial Standard), B5 JIS , B5 JIS , Custom size

Note

- r When **[Custom size]** is selected, the dimensions of the scan area (width and height) can be specified.
 - r When selecting **[Custom size]** for **[Scan Size]**, see p.19 “Selecting a custom size”.
- v **Wait Time for Next Orig.: Exposure Glass**
When dividing originals and scanning them individually with the exposure glass to form a single file, select **[OFF]**, **[Set Wait Time]**, or **[Continuous Wait]** for the waiting status.

 **Note**

- r If either **[SADF]** or **[Batch]** is specified when scanning, this setting is invalid.
- r If **[Off]** is selected, sending will start automatically after one page of original is scanned.
- r If **[Set Wait Time]** is selected, enter the waiting time in seconds (3-999) for placing additional originals with the number keys. Scanning will start when additional originals are placed and the **[Start]** key is pressed within this time. You can end scanning and begin sending by pressing the **[#]** key within this time. If the specified time has passed, sending starts automatically and you do not need to press the **[#]** key.
- r If **[Continuous Wait]** is selected, the machine will wait for additional originals until the **[#]** key is pressed. Scanning will start when additional originals are placed and the **[Start]** key is pressed. You can end scanning and begin sending by pressing the **[#]** key.
- r If originals are placed in the ADF, sending will start without waiting for additional originals after all originals in the ADF have been scanned even if you select **[Continuous Wait]**.
- r If a paper jam occurs or any of the following operation is performed while the machine is waiting for additional originals, the countdown stops and does not start again until the **[#]** key is pressed.
 - Changing the settings such as the scan settings

- Opening the upper cover of the ADF
- Pressing the **[Interrupt]** key to activate the copy mode

- v **Wait Time for Next Original(s): SADF**
When dividing originals and scanning them separately with the ADF to form a single file, select **[Set Wait Time]** or **[Continuous Wait]** for the waiting status.

 **Note**

- r If **[SADF]** is specified when scanning, this setting is valid.
- r If **[Set Wait Time]** is selected, enter the waiting time in seconds (3-999) for placing additional originals with the number keys. Scanning will start automatically when additional originals are placed within this time. You can end scanning and begin sending by pressing the **[#]** key within this time. If the specified time has passed, sending starts automatically and you do not need to press the **[#]** key.
- r If **[Continuous Wait]** is selected, the machine will wait for the additional originals until the **[#]** key is pressed. Scanning will start when additional originals are placed and the **[Start]** key is pressed. You can end scanning and begin sending by pressing the **[#]** key.
- r Even if originals are placed on the exposure glass, the machine will function as the settings. However, every time originals are placed, you must press the **[Start]** key to start scanning.

r If a paper jam occurs or any of the following operation is performed while the machine is waiting for additional originals, the countdown stops and does not start again until the **【#】** key is pressed.

- Changing the settings such as the scan settings
- Opening the upper cover of the ADF
- Pressing the **【Interrupt】** key to activate the copy mode

v **Original Setting**

Set the default for whether originals are one-sided or two-sided and if two-sided, the relationship between those sides. When the originals are always the same, set this for the default to make operation easier. You can select **【1 Sided Original】**, **【2 Sided Orig.:T to T】** (Top to Top), or **【2 Sided Orig.:T to B】** (Top to Bottom).

Reference

p.39 “Original Orientation and Scan Area”

v **Original Feed Type Priority**

Multiple originals can be divided and scanned separately using the exposure glass or ADF to form a single file. In this case, the waiting time for placing additional originals to scan can be specified.

If **【SADF】** is selected, the **【Wait Time for Next Original(s): SADF】** setting will be valid when scanning.

If **【Batch】** is selected, scanning will start when the additional originals are placed and the **【Start】** key is pressed regardless of the setting for **【Wait Time for Next Orig.: Exposure Glass】** or **【Wait Time for Next Original(s): SADF】**.

If **【Off】** is selected, the **【Wait Time for Next Orig.: Exposure Glass】** setting is valid when scanning.

Note

r The countdown for scanning additional originals stops when scanning conditions are changed. The machine keeps waiting for restarting the countdown until the **【#】** key is pressed.

v **Mixed Original Sizes Priority**

This setting determines whether the original size is to be automatically detected when originals of different sizes are inserted in the ADF. You can select **【On】** or **【Off】**.

Note

r If the original size is specified when scanning, this setting is ignored.

r When **【Off】** is selected and **【Auto Detect】** is selected for scan size, if originals of different sizes are placed in the ADF, the maximum size will be detected as the scan size.

v **Original Orientation Priority**

Select the default for original placement orientation. When originals are always positioned the same way, select that orientation as the default to make operation easier.

Reference

p.39 “Original Orientation and Scan Area”

v Change Initial Mode

If you use the settings which are displayed when modes are cleared, reset, or immediately after the operation switch is turned on as the initial mode, select **[Standard]**.

Select **[Program No.10]** when you use the settings stored in Program No.10 as the initial mode.

Selecting a custom size

When selecting **[Custom size]** as the scan size, follow the procedure below.

1 Press **[Custom size]** on the Scan Size Setting screen.

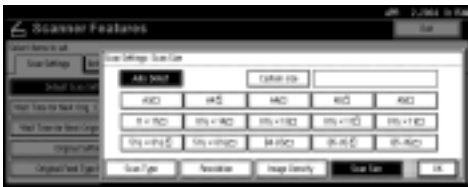

2 Enter the original size with the number keys.

Select and enter values for **[X1]** and **[Y1]**, and then press the **[#]** key.

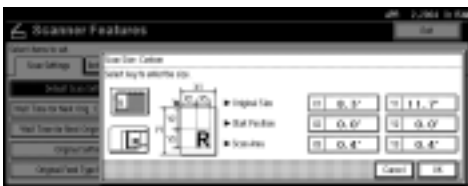

3 Enter the scan starting point in relation to the standard scan starting point.

Select and enter values for **[X2]** and **[Y2]**, and then press the **[#]** key.

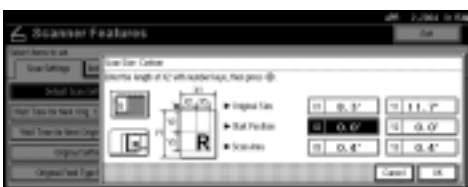

4 Enter the scan size (area) with the number keys.

Select and enter values for **[X3]** and **[Y3]**, and then press the **[#]** key.

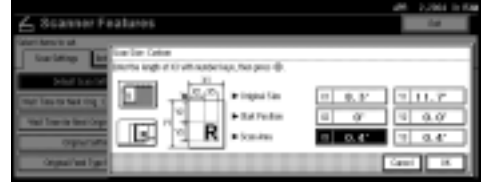

Depending on how the original is positioned, the scan area will be as follows:

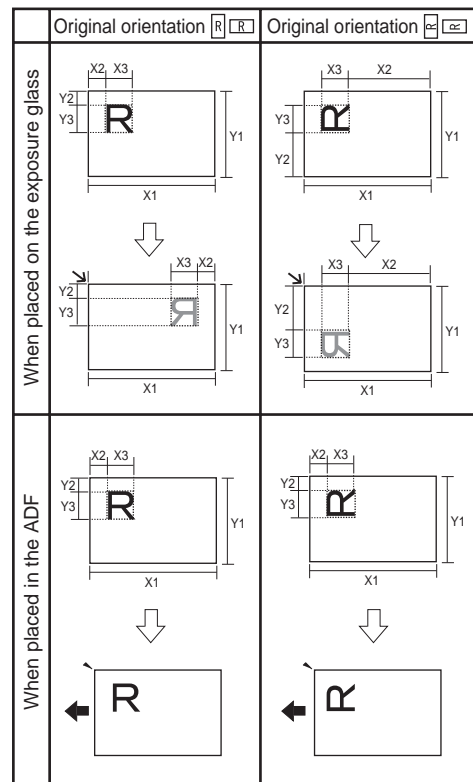

$R\alpha$ shows the face of the original.

$R\alpha$ shows the back of the original.

\leftarrow shows the feeding direction.

The range of possible original sizes and scan sizes is as follows:

- Original Size
 - X1: 140 - 432 mm (5.5" - 17.0")
 - Y1: 140 - 297 mm (5.5" - 11.7")

- Scan Size
 X3: 10 - 432 mm (0.4" - 17.0")
 Y3: 10 - 297 mm (0.4" - 11.7")

Keep the scan area settings within these range.

5 When all dimensions are entered, press **[OK]**.

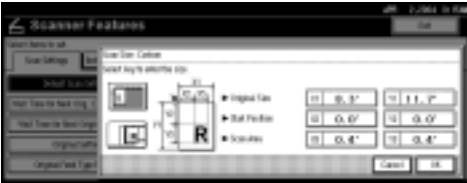

6 Make sure that the area specified in step 4 (X3 and Y3) is shown in the **[Custom size]** field, and then press **[OK]**.



7 Press **[Exit]**.

The main menu reappears.

Destination List Settings

This section explains how to set the defaults for the destination list and titles displayed.

The destination list settings consist of the following. For the list about settings and defaults, see p.13 "Scanner Features".

v Destination List Display Priority 1

Select a destination list to be displayed when the machine is in the initial state. You can select either **[E-mail/ Folder]** or **[Delivery Server]**.

v Destination List Display Priority 2

This function is available when **[E-mail/ Folder]** is selected for **[Destination List Display Priority 1]**.

Select a destination list of the machine to be displayed when the machine is in the initial state.

You can select either **[E-mail Address]** or **[Folder]**.

v Select Title

Select what titles are displayed on the screen. Selecting a title on the screen will display the destinations programmed for that title. This allows for easy selection of destinations including e-mail destinations and Scan to Folder destinations. Select either **[Title 1]** (ten titles), **[Title 2]** (ten titles), or **[Title 3]** (five titles).

v Update Delivery Server Destination List

To update the Delivery Server Destination List, press **[Update Delivery Server Destination List]**.

Ordinarily, the Delivery Server Destination List is automatically updated. This function allows updating at any time.

Send Settings

This section explains how to set the defaults for sending settings such as the compression level for scan file and how the machine switches to the network TWAIN scanner function.

The send settings consist of the following. For the list about settings and defaults, see p.13 “Scanner Features”.

v TWAIN Standby Time

When the machine is being used to send e-mail or a file, or functioning as Document Server or a network delivery scanner, a scanning request to the machine as a TWAIN scanner will switch the machine to the network TWAIN scanner function. This setting determines the delay until the machine switches to the network TWAIN scanner function.

- When **[Off]** is selected, the machine will switch to the network TWAIN scanner function at once.
- When **[On]** is selected, you can enter the delay time with the number keys (3 - 30 seconds). The machine will switch to the network TWAIN scanner function when the time set here passes after the last key operation.

v File Type Priority

Select whether to send the file of scanned originals using a single page or multiple pages.

When sending using multiple pages, select either TIFF or PDF.

Note

- r If you specify multi-page TIFF for file in a JPEG format, the format is automatically changed to PDF.

v Compression (Black & White)

This setting determines whether scan file for the black and white setting is to be compressed.

Note

- r The actual time required for file transfer will vary depending on the file size and network load.
- r Compression reduces the time required for transferring the scan file.

v Compression (Gray Scale)

This setting determines to what extent scan file for the grayscale setting is to be compressed. You can select **[High]**, **[Standard]**, **[Low]**, or **[Off]**.

Note

- r The compression ratio decreases in the order **[High]**, **[Standard]**, **[Low]**, and **[Off]**, and the time required for file transfer increases accordingly.
- r The actual time required for file transfer will vary depending on the file size and network load.

v Print & Delete Scanner Journal

Select whether to print the Scanner Journal automatically when the number of delivered e-mails reaches 100.

Note

- r When printed, all records are deleted after printing. When not printed, records over the limit are automatically deleted in succession from the oldest record.
- r While the journal is being printed, the file whose status is waiting cannot be sent.

v **Max. E-mail Size**

Select whether the size of an e-mail is limited or not.

When **[On]** is selected, enter the size limit (64 - 102400 KB) with the number keys.

Note

- r When the SMTP limits the size, match that setting.

v **Divide & Send E-mail**

This function is effective only when **[On]** is selected for **[Max. E-mail Size]**.

Select whether or not an image exceeding the size specified in **[Max. E-mail Size]** should be divided and sent using more than one e-mail.

Select either **[No]**, **[Yes (per Page)]**, or **[Yes (per Max. Size)]**. When **[Yes (per Max. Size)]** is selected, enter the Max. Number of Divisions (2-500) with the number keys.

Note

- r When **[Multi-page: TIFF]** or **[Multi-page: PDF]** is selected for **[File Type Priority]**, the image will not be divided even if **[Yes (per Page)]** is selected.
- r When **[Yes (per Max. Size)]** is selected, some received files may not be able to be restored, depending on the type of e-mail software.
- r When **[No]** is selected, the e-mail is not sent if its size exceeds the limit, and an error message appears. The scan file is discarded.
- r Set the maximum e-mail size within the capacity of the SMTP server.

v **E-mail Information Language**

Select a language for E-mail Information Language with which Title, Document name, Sender's name and others are sent.

Select one of the following 20 languages: British English, American English, German, French, Italian, Spanish, Dutch, Portuguese, Polish, Czech, Swedish, Finnish, Hungarian, Norwegian, Danish, Japanese, Simplified Chinese, Traditional Chinese, Russian, and Hangul.

Note

- r The e-mail text which is a template cannot be changed.

v **Sender's Name Default**

Select whether an administrator is registered as a sender or a sender is specified each time an e-mail is sent. If the access code has been set, enter the code with the number keys, and then press the **[#]** key.

- Select **[No]** when a sender is to be specified each time.
- Select **[Yes]** when an administrator is to be the sender.

Important

- r It is recommended that protection code be set to prevent the sender's name from being misused.
- r When **[On]** is selected for **[Key Operator Code]** in **[Key Operator Tools]** of System Settings and **[Partial]** is set for the range, enter the access code when **[Sender's Name Default]** is selected. For more information about the System Settings, see "User Tools (System Settings)", *General Settings Guide*.

Programs

You can store frequently used settings in the machine memory and recall them for future use.

Note

- r You can store up to 10 programs for the scanner mode.
- r You can use the settings stored in program No.10 as the initial mode by selecting **[Program No.10]** in **[Change Initial Mode]** in **[Scanner Features]**.
- r Programs are not deleted by turning the power off or by pressing the **[Clear Modes]** key. They are deleted only when you delete or overwrite them with another program.
- r The items which can be stored as a program are as follows: the scan settings, 1 sided/2 sided original, Top to Top/Top to Bottom, Last Page, Original Feed Type, File Type, and Batch/SADF.

Storing a Program

- 1** Edit the settings so all functions you want to store in this program are selected.
- 2** Make sure the **[Scanner]** key is selected, press the **[Program]** key.

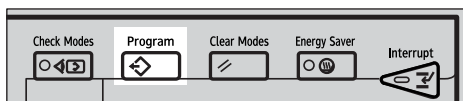

- 3** Press **[Register]**.



- 4** Press the program number you want to use.

Note

- r Program numbers with \diamond already have settings in them.

- 5** Enter the program name with the letter keys on the display panel.

You can enter up to 40 characters.



Reference

For details about entering characters, see "Entering Text", *General Settings Guide*.

Note

- r If it is not necessary to enter the program name, proceed to step **6**.

- 6** Press **[OK]**.

When the settings are successfully stored, \diamond appears on the left side of the registered program number and the program name appears on the right side. The display returns to the initial display after a moment.

Recalling a Program

- 1** Make sure the [Scanner] key is selected, press the [Program] key.
- 2** Press [Recall].



- 3** Press the number of the program you want to recall.
The stored settings are displayed.

Note

Program numbers with ↗ already have settings in them.

- 4** Place the originals, and then press the [Start] key.

Changing a Stored Program

- 1** Make sure the [Scanner] key is selected, press the [Program] key.
- 2** Press [Recall].
- 3** Press the number of the program you want to change.
- 4** Change settings of the program.
- 5** Press the [Program] key.
- 6** Press [Register].
- 7** Press the number of the program you changed the setting.
- 8** Press [Register] to accept the confirmation message.
- 9** Enter a program name.
- 10** Press [OK].

Deleting a Program

- 1** Make sure the [Scanner] key is selected, press the [Program] key.
- 2** Press [Delete].



- 3** Press the number of the program you want to delete.
- 4** Press [Yes].

The program is deleted, and the display returns to the initial display after a moment.

Changing the program name

- 1** Make sure the [Scanner] key is selected, press the [Program] key.
- 2** Press [Change Name].



- 3** Press the number of the program you want to change name.
- 4** Enter a new program name.

A program name can be entered up to 40 characters.

For details about entering characters, see “Entering Text”, *General Settings Guide*.

- 5** Press [OK].

The display returns to the initial display after a moment.

Installing Software

The machine comes with two CD-ROMs containing various software.

The CD-ROM labeled “Scanner Driver & Document Management Utilities” contains the necessary software to use the machine as a network scanner. The CD-ROM labeled “Printer Driver & Utilities” contains the necessary software to use the machine as a printer.

This section explains the software to use the machine as a network scanner.

2

Auto Run Program

When the CD-ROM is inserted into a client computer in Windows 95/98/Me, Windows XP, Windows 2000, or Windows NT 4.0, the installer starts automatically (Auto Run) to install the TWAIN driver and various software.

Note

- r Auto Run might not automatically work with certain operating system settings. In this case, launch “Set up.exe” located in the CD-ROM root directory.
- r If you want to install the software without using Auto Run, hold down the **[Shift]** key while inserting the CD-ROM. Keep the **[Shift]** key held down until the client computer has finished accessing the CD-ROM.
- r If **[Cancel]** is pressed during installation, the installation will be stopped and all the remaining software will not be installed. If **[Cancel]** has been pressed, reinstall the remaining software after restarting the client computer.

Limitation

- r For installation in Windows 2000, Windows XP, or Windows NT 4.0, log in as a member of the administrators group.

The installing sequence using Auto Run is as follows:

Installation Sequence

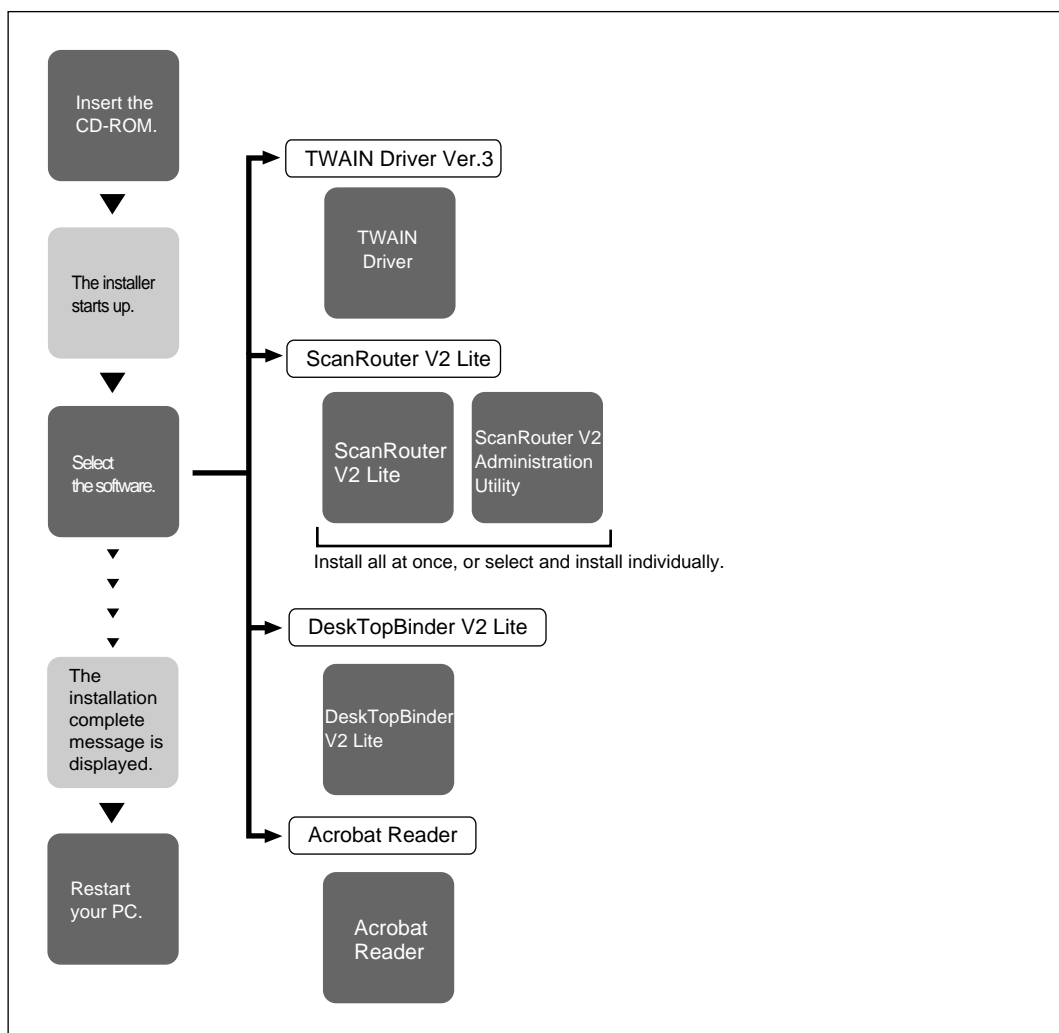

For information about the software that can be installed by Auto Run, see p.29 "Software Supplied on CD-ROM".

Software for Using a Network TWAIN Scanner

To use the machine as a network TWAIN scanner, it is essential to install the TWAIN driver.

If you do not have applications that work with TWAIN, it is necessary to also install DeskTopBinder V2 Lite. For information about the installation of DeskTopBinder V2 Lite, see p.29 “DeskTopBinder V2 Lite”.

Preparation

Before installation, check the operating environment for the TWAIN driver. See p.30 “Type2045e TWAIN Driver”.

Using Windows 95/98/Me, Windows XP, Windows 2000, or Windows NT 4.0

Install the TWAIN driver using Auto Run.

- 1** Start Windows, and then insert the supplied CD-ROM labeled “Scanner Driver & Document Management Utilities” into the CD-ROM drive of the client computer.

The Choose Setup Language screen appears.

Reference

If the installer does not start automatically, see p.25 “Auto Run Program”.

- 2** Select a setup language, and then click [OK].

The CD-ROM Launcher screen appears.

- 3** Click [TWAIN Driver].

The Software Setup screen appears.

- 4** The installer of the TWAIN driver starts. Follow the instructions on the screen.

Note

- r When the installation is complete, a message to prompt you to restart the client computer may appear. In this case, restart the client computer.
- r After the installation is complete, the “Type2045e TWAIN V3” folder is in the “Program” folder on the Start menu. Help can be displayed from here.
- r Notes on using the network TWAIN scanner are provided in “Readme.txt”. Be sure to read them before use.

Software for Using the Network Delivery Scanner Function

To use the machine as a network delivery scanner, it is essential to install ScanRouter V2 Lite on the delivery server. To check an in-tray or retrieve file, it is necessary to install TWAIN Driver on the client computer.

Use Auto Run for installation.

2

Preparation

Before installation, check the system requirements for the software. See p.29 “Software Supplied on CD-ROM”.

1 Start Windows, and then insert the supplied CD-ROM labeled “Scanner Driver & Document Management Utilities” into the CD-ROM drive of the client computer.

The Choose Setup Language screen appears.

2 Select a setup language, and then click [OK].

The CD-ROM Launcher screen appears.

3 Click the key of the software to be installed.

- The ScanRouter V2 Lite installer starts by clicking [ScanRouter V2 Lite].
- The DeskTopBinder V2 Lite installer starts by clicking [DeskTopBinder V2 Lite].

The Change The Language screen appears.

4 Select a language, and then click [OK].

The Software Setup screen appears.

Reference

For information about the subsequent installation procedure, see *Setup Guide* that can be displayed from the Setup screen of the respective software.

DeskTopBinder V2 Lite

Use Auto Run for installation.

Preparation

Before installation, check the system requirements for DeskTopBinder V2 Lite. See p.31 “DeskTopBinder V2 Lite”.

- 1 Start Windows, and then insert the supplied CD-ROM labeled “Scanner Driver & Document Management Utilities” into the CD-ROM drive of the client computer.**

The Choose Setup Language screen appears.

- 2 Select a language, and then click [OK].**

The CD-ROM Launcher screen appears.

- 3 Click [DeskTopBinder V2 Lite].**

The Change The Language screen appears.

- 4 Select a language, and then click [OK].**











The Software Setup screen appears.

Reference

For information about the subsequent installation procedure, see *Setup Guide* that can be displayed from the Setup screen of DeskTopBinder V2 Lite.

Software Supplied on CD-ROM

List of files

 CD-ROM Drive	 Wizard for the TWAIN driver and utilities		
	 Drivers	 Twain	TWAIN driver for Windows 95/98/Me, Windows XP, Windows 2000, Windows NT 4.0
	 Utility	 RouterV2	 ScanRouter V2 Lite ,  ScanRouter V2 Administration Utility
		 DeskV2	 DeskTopBinder V2 Lite
 Acroread		Acrobat Reader	

Type2045e TWAIN Driver

This driver is required to scan an original on the machine.

To use the machine as a network TWAIN scanner, this driver must be installed.

v File storage folder

The files are stored in the following folder on the CD-ROM provided with this machine:

`\DRIVERS\TWAIN`

v System requirements

📍 Limitation

r Under Windows NT with RISC-based processors (MIPS R series, Alpha AXP, or PowerPC), this driver is not available.

- Hardware
PC/AT compatible
- CPU
Pentium or faster (Pentium 150 MHz or faster recommended)
- Operating system
Microsoft Windows 95 (OSR 2 or later)
Microsoft Windows 98
Microsoft Windows Millennium Edition
Microsoft Windows XP Professional
Microsoft Windows XP Home Edition
Microsoft Windows 2000 Server
Microsoft Windows 2000 Professional
Microsoft Windows NT Server 4.0 (Service Pack 5 or later)
Microsoft Windows NT Workstation 4.0 (Service Pack 5 or later)
- Memory
Operating system min. operation memory + 8 MB (64 MB or more recommended)
- Hard disk space
100 MB or more
- Display resolution
800 × 600 pixels, 256 colors or higher
- Network protocol
TCP/IP

DeskTopBinder V2 Lite

DeskTopBinder V2 Lite is to be installed on the client computers for integration and management of various kinds of file such as scan file, files created with applications, and existing scan files. This software allows you to use various functions for scan files stored in the Document Server, e.g., viewing stored files. Also, with ScanRouter V2 Lite, you can view the files stored in in-trays of the delivery server or use other functions for stored files.

Reference

See DeskTopBinder V2 Lite Help or the manuals for DeskTopBinder V2 Lite.

v File storage folder

The files are stored in the following folder on the CD-ROM provided with this machine:

`\UTILITY\DESKV2`

v System requirements

- Hardware
PC/AT compatible
- CPU
Pentium 133 MHz or faster (Pentium II 266 MHz or faster recommended)
- Operating system
Microsoft Windows 95 (OSR 2 or later)
Microsoft Windows 98
Microsoft Windows Millennium Edition
Microsoft Windows XP Professional
Microsoft Windows XP Home Edition
Microsoft Windows 2000 Server (Service Pack 1 or later)
Microsoft Windows 2000 Professional (Service Pack 1 or later)
Microsoft Windows Server 2003 Standard Edition
Microsoft Windows Server 2003 Enterprise Edition
Microsoft Windows Server 2003 Web Edition
Microsoft Windows NT Server 4.0 (Service Pack 5 or later)
Microsoft Windows NT Workstation 4.0 (Service Pack 5 or later)
- Memory
48 MB or more (128 MB or more recommended)
- Hard disk space
50 MB or more (200 MB or more recommended)
- Display resolution
800 × 600 pixels, 64K colors or higher
- Network protocol
TCP/IP

▼ Software installed with DeskTopBinder V2 Lite

- Auto Document Link
Auto Document Link on the client computer monitors in-trays of the delivery server. In addition, the file delivered to in-trays can be retrieved or the arrival of file can be received at the client computer with this software.
- Function Palette
Function Palette allows you to use functions such as the network TWAIN scanner, printing, printing preview, sending files by e-mail or sending faxes without starting DeskTopBinder V2 Lite. You must make settings in advance in the **[Extended Features]** to use Function Palette. Refer to manuals related to DeskTopBinder V2/Lt for the details.
- Extended Features Wizard
You can make settings equal to **[Extended Features]** of the **[Tools]** menu with Extended Features Wizard. Refer to manuals related to DeskTopBinder V2/Lt for the details.

ScanRouter V2 Lite

ScanRouter V2 Lite is to be installed on the delivery server. The scan file can be sorted in the delivery server, stored in specified in-trays, or saved in folders of client computers on the same network.

Reference

See the manuals for ScanRouter V2 Lite or ScanRouter V2 Lite Help.

▼ File storage folder

The files are stored in the following folder on the CD-ROM provided with this machine:

`\UTILITY\ROUTERV2`

▼ System requirements

Limitation

- r When installing the software in Windows NT Server or Windows 2000 Server, a stand-alone server must be used. Do not use the primary domain controller or backup domain controller.
 - r If you install this software in an operating system, such as Windows NT Workstation and Windows 2000 Professional, in which a client server is not permitted to be used in a network, you may violate the license agreement of Microsoft Corporation.
- Hardware
PC/AT compatible
 - CPU
Pentium 200 MHz or faster (Pentium II 350 MHz or faster recommended)

- Operating system
 - Microsoft Windows 95 (OSR 2 or later)
 - Microsoft Windows 98
 - Microsoft Windows Millennium Edition
 - Microsoft Windows XP Professional
 - Microsoft Windows XP Home Edition
 - Microsoft Windows 2000 Server (Service Pack 1 or later)
 - Microsoft Windows 2000 Professional (Service Pack 1 or later)
 - Microsoft Windows NT Server 4.0 (Service Pack 5 or later)
 - Microsoft Windows NT Workstation 4.0 (Service Pack 5 or later)

- Memory
 - 64 MB or more (128 MB or more recommended)

- Hard disk space
 - Minimum free space required for installing: 200 MB

 **Note**

r In addition to the space required for installation, the hard disk should have at least 500 MB of free space for files.

- Network protocol
 - TCP/IP

v **Software installed with ScanRouter V2 Lite**

- ScanRouter V2 Administration Utility
 - ScanRouter V2 Administration Utility manages the delivery system run by ScanRouter V2 Lite.
 - You can register destination and sender information for the scanned documents in the delivery server. In addition, you can perform maintenance for free disk space monitoring, error log recording, and other features of the delivery server.

 **Note**

r ScanRouter V2 Administration Utility can be installed not only on the delivery server but also on client computers. To install it, click **[ScanRouter V2 Administration Utility]** on the ScanRouter V2 Lite Setup screen.

3. Setting Originals



This chapter explains the procedure for placing originals on the exposure glass and in the ADF, and setting the original scan area and orientation according to the placement method.

To correctly display the top/bottom orientation of the scanned original on a client computer, the placement of the original and the settings made on the control panel and scanner driver must match.





Placing Originals

There are two orientations for placing the original. See the table below.

Note

- r Normally, an original is  or , but in the table below, a square original is used to make original orientation easy to understand. If the actual shape of the original is different, the combination of original orientation and the orientation specified on the control panel or scanner driver does not change.

v Specifying original orientation and setting originals

<p>1 An original to be scanned</p>				
<p>2 Decide the placement method.</p>	Exposure glass		ADF	
<p>3 Place the original. (There are two original orientations.)</p>	<p>Place the original so that the top edge touches the top left of the exposure glass.</p> 	<p>Place the original so that the top edge touches the rear of the exposure glass.</p> 	<p>Place the top edge of the original first.</p> 	<p>Place the original so that the top edge touches the back of the ADF.</p> 

<p>4 Specify the orientation.</p>	<p>When scanning using the e-mail function, the Scan to Folder function, the Document Server function, or the delivery scanner function. (Specified on the control panel screen)</p>				
	<p>When scanning using the TWAIN scanner function (Specified in the Scanner Control dialog box)</p>				
<p>5 The original displayed on a computer</p>					

Placing on the Exposure Glass

Originals which do not fit into the ADF, such as sheets with glued-on parts, books, etc., can be placed directly on the exposure glass for scanning.

Note

r For information about the originals which can be placed on the exposure glass, see *Copy Reference*.

1 Lift the exposure glass cover or the ADF.

Note

r Lift the exposure glass cover or ADF more than 30 degrees. The opening/closing action triggers the automatic original size detection process.

2 Place the original on the exposure glass with the side to be scanned facing down. Align the original with the back left corner mark.

There are two original orientations.

- ✓ When placing the original so that the top edge touches the rear of the exposure glass

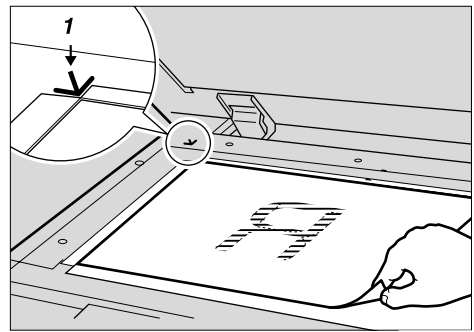

1. Positioning mark

- v **When placing the original so that the top edge touches the top left of the exposure glass**

When using the machine as a network TWAIN scanner, this orientation is the standard setting for the TWAIN driver. Normally, use this orientation for placing originals.

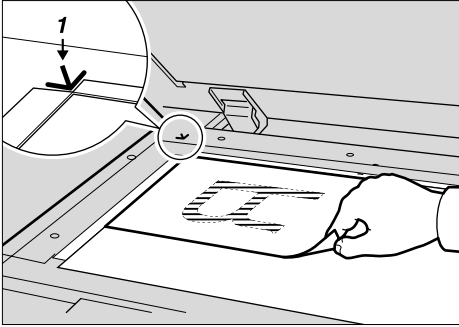

1. Positioning mark

- 3** Lower the exposure glass cover or the ADF.
- 4** Select the original orientation according to the orientation of the placed original.

Reference

p.35 "Specifying original orientation and setting originals"

Proceed to p.39 "Original Orientation and Scan Area".

Placing in the Auto Document Feeder

The ADF allows you to place multiple originals at one time. Originals placed in the ADF can be scanned on one side or both sides.

- v **Originals that can and cannot be placed in the ADF**

For information about the originals that can and cannot be placed in the ADF, see *Copy Reference*.

Attempting to use unsuitable originals in the ADF can lead to a misfeed and damage to the originals. Place such originals directly on the exposure glass.

Important

- r For information about which original sizes can be detected automatically and notes on placing originals in the ADF, see *Copy Reference*.

- 1** Adjust the original guide to match the size of the originals.
- 2** Place the originals with the side to be scanned facing up. (For originals which are to be scanned on both sides, the first side should face up.)

There are two orientations.

- v **When placing the originals so that the top edges touch the back of the ADF**

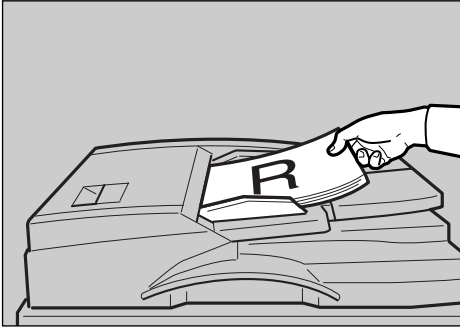

3

- v **When placing the top edges of the originals first**
When using the machine as a network TWAIN scanner, this orientation is the standard setting for the TWAIN driver. Normally, use this orientation for placement.

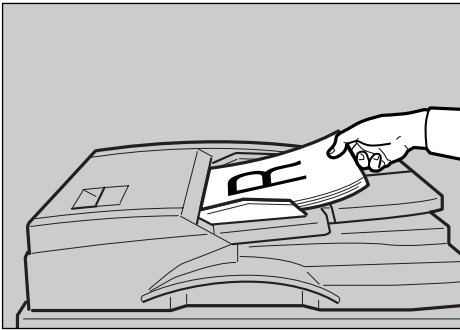

 **Note**

- r Originals with different sizes can be placed at the same time. Place the originals as shown:

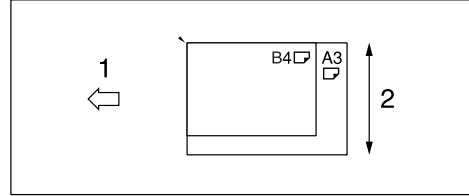

1. ADF placement orientation

2. Height

- r Originals are scanned in the inserted order, starting with the topmost page.

3 Select the original orientation according to the orientation of the placed originals.

 **Reference**

p.35 "Specifying original orientation and setting originals"

Proceed to p.39 "Original Orientation and Scan Area".

Original Orientation and Scan Area

To correctly display the top/bottom orientation of a scanned original on a client computer, original orientation and page flow must be set when placing the original.

When using the e-mail function, the Scan to Folder function, the Document Server function, and the network delivery scanner function, settings are made on the control panel of the machine. When using the machine as a network TWAIN scanner, settings are made with the TWAIN driver.

 **Note**

r The difference between scanning with the TWAIN scanner function and the e-mail function, the Scan to Folder function, the Document Server function, or the network delivery scanner function is shown in the following table:

	TWAIN Scanner	E-mail/Scan to Folder/Document Server/Network Delivery Scanner
Auto Detect Non-Mixed Original Sizes	A whole batch of originals is scanned using the size of the first original.	Auto detection is used to determine the size of each original placed on the exposure glass. A whole batch of originals set in the ADF will be scanned by the maximum size original.

	TWAIN Scanner	E-mail/Scan to Folder/Document Server/Network Delivery Scanner
Auto Detect Mixed Original Sizes	Auto detection is used to determine the size of each original.	
Size Specification	When an original is smaller than the specified size, a blank space appears in the resulting image.	

For E-mail, Scan to Folder, and a Network Delivery Scanner

1 Make settings for one-sided/two-sided combination, Batch/SADF, mixed original sizes, and original orientation.



Note

The defaults can be changed using the initial scan settings [Original Setting], [Original Feed Type Priority], [Mixed Original Sizes Priority], and [Original Orientation Priority]. See p.16 “Scan Settings”.

One-sided original/Two-sided original selection

- A When scanning one-sided originals, make sure that [1 Sided Orig.] is selected.
- B When scanning two-sided originals, press [2 Sided Orig.] to select [2 sided orig.: T to T] or [2 sided orig.: T to B] according to the binding orientation of the original.

Top to top original:



Top to bottom original:

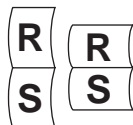

- C When the last page of two-sided originals is blank, select [1 Side] to skip that side and finish scanning, or select [2 Sides] to scan that side as a blank page.

Note

When [1 Side] is selected for [Last Page], file size will be bigger than the one for the originals, and the e-mail cannot be sent beyond the limit of Max. E-mail Size. In this case, change the setting of [Max. E-mail Size] of [Scanner Features].

Press [OK].

2 Make settings for Batch/SADF, mixed original sizes, and original orientation, and then press [Original Feed Type].



Batch/SADF selection

- A When scanning a large number of originals by dividing the originals and scanning them individually or in batches, check that either [Batch] or [SADF] is selected.

Note

Select [SADF], and the setting of [Wait Time for Next Original(s): SADF] of [Scan Settings] of [Scanner Features] is available. Or select [Batch], and the machine waits until additional originals are set. See p.42 “Scanning Originals in Several Times”.



Mixed size selection

A When originals of different sizes are placed, select **[Mixed Size]**.

 **Note**

- r If **[Mixed Size]** is selected and **[Auto Detect]** is selected for scan size, the maximum size detected is set as the scan size. For originals smaller than this size, a blank space will appear in the resulting image.
- r Originals of different width may be sometimes scanned a little slantways because the guide of the original cannot be fitted to the size of the small original.

Orientation selection

A Press the key for the same orientation as the actual orientation of the original,  or .

 **Reference**

p.35 “Specifying original orientation and setting originals”

3 Press **[OK]**.

 **Note**

- r The current settings are displayed.





For a Network TWAIN Scanner

1 Open the Scanner Properties dialog box.

 **Reference**

p.96 “Scanning Originals”

2 Select the position from the **[Document:]** list in the **[Document]** area.

3 Select  or  from the **[Orientation:]** list.

 **Reference**

p.35 “Specifying original orientation and setting originals”

4 When the originals are placed in the ADF, select **[Simplex]** or **[Duplex]** in the **[Side:]** list.

 **Note**

- r If originals of different sizes are placed in the ADF, specify the document size or detection method in the **[Size:]** box. If **[Auto detection (Uni-size)]** is selected, all originals are scanned using the size of the first page. If **[Auto detection (Multi-size)]** is selected, all originals are scanned according to their own width. For both Uni-size and Multi-size, all originals are scanned using their own length.

Scanning Originals in Several Times

Multiple originals can be scanned as a single file by dividing them and scanning them using the exposure glass or the ADF. When scanning originals dividing in several times, there are two waiting status for setting additional originals: the machine waits for a designated time, or keeps waiting until an additional original is set.

Specifying a time limit for additional originals

In advance, specify the waiting time in seconds for placing the additional originals.

- Scanning using the exposure glass
Select **[Set Wait Time]** for **[Wait Time for Next Orig.: Exposure Glass]**.
- Scanning using the ADF
Select **[Set Wait Time]** for **[Wait Time for Next Original(s): SADF]**.

Reference

p.16 "Wait Time for Next Orig.: Exposure Glass" or "Wait Time for Next Original(s): SADF"

1 Place the originals.

Reference

p.35 "Placing Originals"

Note

- r Originals are scanned in order. Place them from the first page.

2 Make settings for scanning area and original orientation.



Reference

p.39 "Original Orientation and Scan Area"

3 Make settings for sending by e-mail, Scan to Folder, storing, or delivering.

Reference

p.47 "Procedure for Sending E-mail"

p.61 "Procedure for Sending by Scan to Folder"

p.74 "Storage Procedure"

p.87 "Delivery Procedure"

When using the exposure glass

A Press the **[Start]** key.

When scanning is finished, the remainder time until the additional original is placed is displayed.



B When there are additional originals, place them within the specified time, and then press the **[Start]** key.

Repeat this procedure until the last original is scanned.

Note

- r When the scan settings are changed while performing the procedure, the countdown for additional originals is stopped. Press the **[Start]** key to restart the countdown.

When using the ADF

A Select **[SADF]** in **[Original Feed Type]**.

B Press the **[Start]** key.

When scanning is finished, the remainder time until the additional original is placed is displayed.



C When there are additional originals, repeat placing them within the specified time.

The machine starts scanning automatically.

Note

- r When the scan settings are changed while performing the procedure, the countdown for additional originals is stopped. Press the **[Start]** key to restart the countdown.
- r You can also use the exposure glass instead of the ADF. In this case, you must press the **[Start]** key to start scanning.

D When all originals are scanned and the countdown is finished, the machine starts storing or sending automatically.

Note

- r You can also press the **[#]** key to restart storing or sending.

Not specifying a time limit for additional originals

1 Place the originals.

Reference

See p.35 "Placing Originals".

Note

- r Originals are scanned in order. Place them from the first page.

2 Make settings for scanning area and original orientation.

Reference

p.39 "Original Orientation and Scan Area"

3 Select **[Batch]** for **[Original Feed Type]**.



4 Make settings for sending by e-mail, or Scan to Folder, storing, or delivering.

Reference

p.47 "Procedure for Sending E-mail"

p.61 "Procedure for Sending by Scan to Folder"

p.74 "Storage Procedure"

p.87 "Delivery Procedure"

5 Press the **[Start]** key.



6 When there are additional originals to scan, place them and press the **[Start]** key.

Repeat this step until all originals are scanned.

7 After all originals are scanned, press the **[#]** key.

Storing or sending will start.

3

4. Sending Scan File by E-mail

Scan file can be sent from this machine to a specified destination using e-mail system. This chapter explains the preparation for sending file by e-mail system, various display screens, procedures for sending, and how to check the sending result when this function is used.

Preparation for Sending by E-mail

To send by e-mail system, the preparation described below is required.

Note

- r Set up an e-mail server on the network in advance. For information about setting up an e-mail server, see the instruction manuals of the e-mail server to be used and the software to be installed.

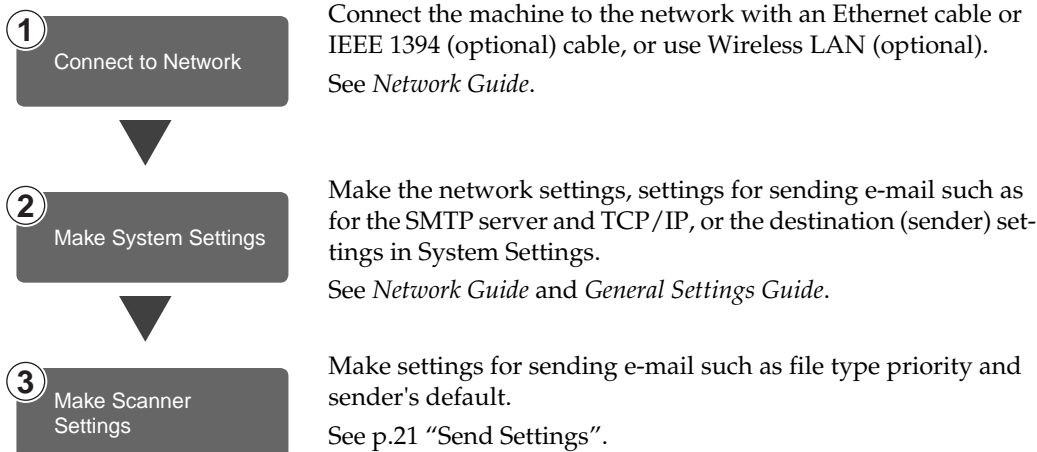

E-mail Screen

The screen when using the machine for e-mail is as shown.

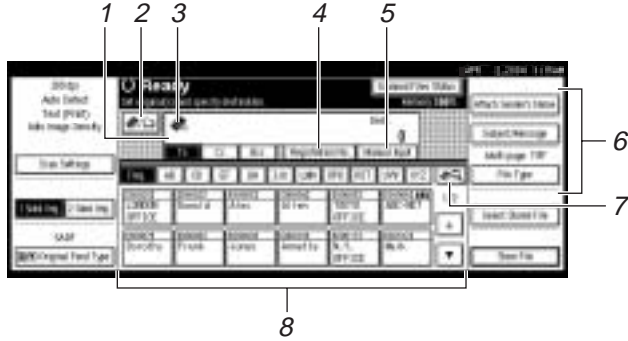

1. Destination field

The selected destination is shown here. If multiple destinations are selected, the destinations are displayed in the order they were selected by pressing [**▲ Prev.**] or [**▼ Next**].

Note

r Pressing the [**Check Modes**] key lets you check the selected destinations.

2. E-mail/Scan to Folder

Press to switch the e-mail function to the Scan to Folder function. You can send file to the destinations for both e-mail and Scan to Folder at the same time.

3. E-mail icon

Shows that the screen for sending e-mail is displayed.

4. [Registration No.]

Press to specify a destination using a five-digit registration number.

5. [Manual Input]

When specifying a destination that is not listed, press [**Manual Input**], and then enter the destination with the soft keyboard.

6. [Attach Sender's Name] [Subject/Message] [File Type]

Set the sender, subject, and message of the e-mail to be sent.

If necessary, set the file type and file name of the scan file attached to the e-mail.

7. [Switch Destination List/Search/Switch Title]

Press to switch a destination from the delivery server list to the destination list of this machine, to search for an e-mail destination, or to switch the titles.

8. Destination List

Displays the destinations programmed in the delivery server or this machine.

Note

r When the entire list does not fit on one screen, [**▲**] or [**▼**] can be used to scroll through the display.

r Group destinations are denoted by this symbol ().

Sending Scan File by E-mail

Procedure for Sending E-mail

Scan file is sent after specifying scan settings and destinations.

1 Press the **[Scanner]** key.

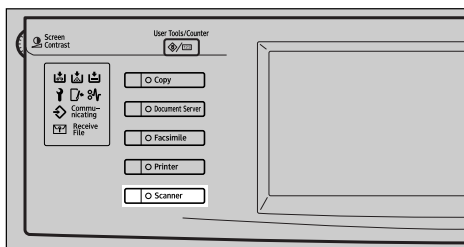

2 If user codes are set, enter a user code with the number keys, and then press the **[#]** key.

The Scanner Function screen appears.

Reference

For information about user codes, see *General Settings Guide*.

3 Make sure that no previous settings remain.

Note

If a previous setting remains, press the **[Clear Modes]** key.

4 Place the original in the machine, and then adjust the scan settings and settings for orientation and pageflow if necessary.

To make the scan settings, recall stored settings or make the settings individually.

Reference

p.16 "Scan Settings"

p.35 "Setting Originals"

Recalling stored scan settings

A Press the **[Program]** key.

B Select a program of scan settings.



The settings of the selected program are applied.

Making the settings individually

A Press **[Scan Settings]**.

B Select items such as resolution and original size, and then change their settings.



Scan settings can be made in the same way as Default Scan Settings. See p.16 "Default Scan Settings".

C Press **[OK]**.

5 If the network delivery scanner screen appears, switch to the screen for sending e-mail.

A Press **[F5]**.

B Press **[Switch Destination List]**.



C Press **[E-mail]**.



D Press **[Exit]**.

The E-mail screen appears.

6 Specify the destination.

To specify a destination, you can select it from the list, select it by specifying a registration number, enter the e-mail address directly, search for the destination from the Destination List and selecting it, or search for the destination from the LDAP server and selecting it.

Note

Before selecting the destination, be sure to select **[To]**. If necessary, select **[Cc]** or **[Bcc]** and the respective destinations. More than 500 destinations cannot be specified for **[To]**, **[Cc]**, and **[Bcc]**.

Reference

See p.103 "Max. Number of Addresses Which Can Be Specified and Files Which Can Be Stored".

When selecting a destination from the list

A Press the title for the destination. The destinations for that title are displayed.

If the destination is not displayed, press **[▲]** or **[▼]** to display the destination.



B Select the destination to which the scan file is to be sent.



The selected destination is highlighted and also displayed in the destination field at the top of the screen.

C To select more destinations, repeat step B.

Note

To deselect a destination, press the destination once more, or press **[▲ Prev.]** or **[▼ Next]** to display the destination in the destination field, and then press the **[Clear/Stop]** key.

Using a registration number to select a destination

- A Press [Registration No.].**
- B Use the number keys to enter the five-digit registration number that has been assigned to a destination.**

If the entered number is less than five digits long, press the **[#]** key after the last number.

Example: To enter 00005

Press the **[5]** key, and then press the **[#]** key.



- C To select more destinations, repeat step B.**

Note

- r To deselect a destination, press **[▲ Prev.]** or **[▼ Next]** to display the destination in the destination field, and then press the **[Clear/Stop]** key.

Manual entry of an e-mail address

- A Press [Manual Input].**

The soft keyboard is displayed for entering the e-mail address.

- B Enter the e-mail address.**

Note

- r It is possible to use letters, numbers, and periods. The symbols **() \ , ; : "** cannot be used.

Reference

For information about how to enter characters, see *General Settings Guide*.

- C Press [OK].**

Note

- r An e-mail address entered manually can be registered in the list. Press **[ProgDest]** , and a screen for entering the address appears. For information about registering destinations, see *General Settings Guide*.
 - r To change an e-mail address that has been entered, press **[Change]** located on the left side of the destination field. A soft keyboard for entering the e-mail address is displayed. Make any changes, and then press **[OK]** .
 - r Pressing the **[Check Modes]** key on the control panel lets you check the list of selected destinations.
- D To enter more destinations, repeat steps A to C.**

Note

- r To deselect a destination, press **[▲ Prev.]** or **[▼ Next]** to display the destination in the destination field, and then press the **[Clear/Stop]** key.

Searching to select a destination from the Destination List

A Press **[F4]**.



B Press **[Search by Dest. Name]**.



Note

r To search using e-mail addresses, press **[E-mail Address]**.

The soft keyboard is displayed for entering a user name.

C Enter part of the destination name.

Note

r Enter the first character or characters of the destination name.

r It is also possible to perform a combined search using **[Search by Dest. Name]** and **[E-mail Address]**.

r It is necessary to differentiate between capital and small letters.

Reference

For information about how to enter characters, see *General Settings Guide*.

D Press **[OK]**.

E Select a destination.



F Press **[Exit]**.

Searching to select a destination from the LDAP server

A Press **[F4]**.



B Press **[Search LDAP]**.



C Press **[Advanced Search]**.



D Enter information for each item of the destination.



Note

- r Press the item, and the soft keyboard is displayed for entering information appears. Enter the first character or characters of the item.
- r One reference item of Advanced Search can be added when **[Search Options]** is specified in **[Program/ Change LDAP Server]** of **[Key Operator Tools]** of **[System Settings]**. For more information, see “User Tools (System Settings)”, *General Settings Guide*.
- r It is necessary to differentiate between capital and small letters.

Reference

For information about how to enter characters, see *General Settings Guide*.

- E Press [Search Criteria] corresponding to each item and then select criteria from the list to be displayed.**

**Note**

- r You can select criteria from the following list:
 - **[Search Beginning Word]:** The name located in front of an entered character is looked up.
 - **[Search End Word]:** The name located at the back of an entered character is looked up.

- **[Exact Match]:** The name which corresponds to an entered character is looked up.
- **[Include One of Words]:** The name which contains an entered character is looked up.
- **[Exclude Words]:** The name which does not contain an entered character is looked up.
- **[Fuzzy Search]:** a vague reference (The function of the vague reference depends on the system supported by the LDAP server.)

- F Press [OK].**

Note

- r If a user name and password for the LDAP authentication are not set, a screen for entering a user name and password will appear. Enter them to log on.
- r A destination cannot be specified as a proper address when the number of characters of the e-mail address searched from the LDAP server exceeds 128 characters.
- r Some e-mail addresses can be registered for one person, but only one e-mail address can be hit by searching. Depending on the system supported by the LDAP server, generally, the address which was registered for first is hit.

- G Select a destination.**

H Press **[Exit]**.

 **Note**

- r A searched e-mail address can be registered in the list. Press **[ProgDest]**, and a screen for entering the address appears. For information about registering destinations, see *General Settings Guide*.

Checking selected destinations

A Use the destination field at the top of the screen to check which destinations are selected.

 **Note**

- r When multiple destinations are selected, the selected destinations are displayed in the order they were selected by pressing **[▲ Prev.]** or **[▼ Next]**.
- r Pressing the **[Check Modes]** key on the control panel lets you check the list of selected destinations.

7 Select the file type if necessary.

- A Press **[File Type]**.
- B Select the file type of the file to be attached to the e-mail from the displayed types.



- C Press **[OK]**.

8 Specify the file name of the file to be sent if necessary.

- A Press **[File Type]**.
- B Press **[File Name]**.

The soft keyboard is displayed for entering a file name.

- C Enter a file name.
- D Press **[OK]** twice.

9 Specify the e-mail sender.

To specify a sender, you can select the sender from the list, enter the five-digit registration number of the sender with the number keys, and search for the sender and selecting it.

 **Note**

- r The operation of step **9** is unnecessary when **[Key Operator's E-mail Address]** is specified for **[Sender's Name Default]** in **[Send Settings]** of **[Scanner Features]**. Proceed to step **10**.
- r When a sender is selected, the sender name is automatically placed in the From field of the e-mail so that the sender can be identified when the e-mail is received.
- r To prevent misuse of a sender name, we recommend you set protection code for that sender name.
- r Be sure to select or enter a sender name. Otherwise **[Key Operator's E-mail Address]** is used as the sender name. See *General Settings Guide*.

When selecting a sender from the list

A Press **[Attach Sender's Name]**.



B Select the sender.



Note

- r When a protection code has been set, a screen for entering the protection code appears after selecting the sender. Enter the protection code, and then press **[OK]**. When the protection code you entered is correct, the sender name is displayed.

C For a reception confirmation e-mail, press **[Return Receipt]**.



Note

- r When **[Return Receipt]** is selected, an e-mail notifying that the e-mail has been read by the destination party is sent to the sender selected here. However, if the mailing software used by the destination party does not support MDN (Message Disposition Notification), the e-mail may not be sent.

D Press **[OK]**.

Using a registration number to specify a sender name

A Press **[Attach Sender's Name]**.



B Use the number keys to enter the five-digit registration number that has been assigned to a sender.

If the entered number is less than five digits long, press the **[#]** key after the last number.

Example: To enter 00008

Press the **[8]** key, and then press the **[#]** key.

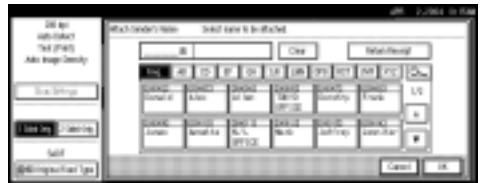

Note

- r When a protection code has been set, a screen for entering the protection code appears after selecting the sender. Enter the protection code, and then press **[OK]**. When the protection code you entered is correct, the sender name is displayed.

C For a reception confirmation e-mail, press **[Return Receipt]**.

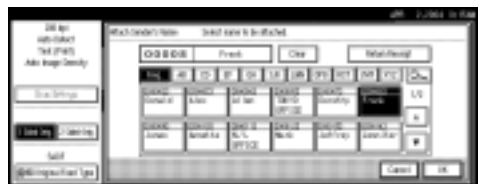

Note

- r When **[Return Receipt]** is selected, an e-mail notifying that the e-mail has been read by the destination party is sent to the sender selected here. However, if the mailing software used by the destination party does not support MDN (Message Disposition Notification), the e-mail may not be sent.

D Press **[OK]**.

Searching to select a sender

A Press **[Attach Sender's Name]**.



B Press **[F1]**.



C Press **[User (Dest.) Name]**.

To search using e-mail addresses, press **[E-mail Address]**.



The soft keyboard is displayed for entering a user name.

D Enter part of the sender name.

Note

- r Enter the first character or characters of the sender name.
- r It is also possible to perform a combined search using **[User (Dest.) Name]** and **[E-mail Address]**.
- r It is necessary to differentiate between capital and small letters.

Reference

For information about how to enter characters, see *General Settings Guide*.

E Press **[OK]**.

F Select the sender.



Note

- r When a protection code has been set, a screen for entering the protection code appears after selecting the sender. Enter the protection code, and then press **[OK]**. When the protection code you entered is correct, the sender name is displayed.

G Press **[Exit]**.

H For a reception confirmation e-mail, press **[Return Receipt]**.

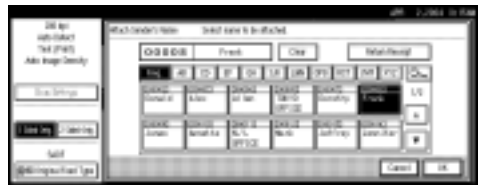

Note

- r When **[Return Receipt]** is selected, an e-mail notifying that the e-mail has been read by the destination party is sent to the sender selected here. However, if the mailing software used by the destination party does not support MDN (Message Disposition Notification), the setting in **[Return Receipt]** becomes invalid.

l Press **[OK]**.

10 Specify a subject if necessary.

Note

- r When a subject has been set, this information is added to the scan file. The subject name is automatically placed in the Subject field of the e-mail.
- r To specify a subject name, you can select it from the list, enter it directly, or combine selecting and entering it.
- r Subject name to select from the list must be registered in System Settings in advance. See *Network Guide*.
- r Subject name can be entered up to 64 characters including characters of the name selected from the list.

The operation to specify a subject name “[Urgent] New product appearance” is explained as an example here.

A Press **[Subject/Message]**.

B Press **[Attach Subject]**.



C Select a subject **[Urgent]**.

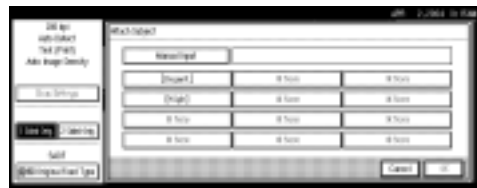

D Press **[Manual Input]**.

The soft keyboard is displayed for entering a subject.

E Enter the subject “New product appearance”.

Reference

For information about how to enter characters, see *General Settings Guide*.

F Press **[OK]**.

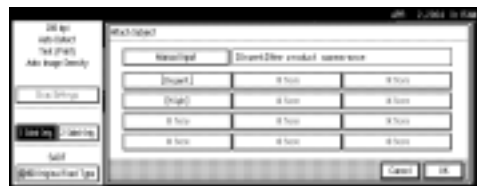

G Press **[OK]**.

11 Enter a message if necessary.

Note

- r When a message has been entered, this information is added to the scan file.
- r Message to select from the list must be registered in System Settings in advance. See *Network Guide*.
- r Message can be entered to up to 80 characters.
- r To specify a message, you can select it from the list, or enter it directly.

When selecting a message from the list

- A Press **[Subject/Message]**.
- B Press **[E-mail Message]**.



C Select a message.



D Press **[OK]** twice.

Manual entry of a message

The operation to specify a message "Thank you for what you did yesterday." is explained as an example here.

- A Press **[Subject/Message]**.
- B Press **[E-mail Message]**.



C Press **[Manual Input]**.

The soft keyboard is displayed for entering a message.

D Enter the message "Thank you for what you did yesterday".

Reference

For information about how to enter characters, see *General Settings Guide*.

Note

r Message can be entered to up to 80 characters.

E Press **[OK]** three times.



12 Press the **[Start]** key.

Note

- r To interrupt scanning, press the **[Clear/Stop]** key or press **[Stop]** on the screen.
- r When using the Batch function or the SADF function, place the next original after the others have been scanned. See p.42 "Scanning Originals in Several Times".
- r Regardless of the divide e-mail size setting, it is not possible to send e-mail with over 725.3MB of data. It is also not possible to send over 1,000 pages of file.

Simultaneous Storage and Sending by E-mail

You can use e-mail with the Document Server.

Scan file is stored in the Document Server at the same time the file is sent by e-mail.

Note

- r This section explains mainly the operation for simultaneous storage and sending of e-mail. For more information, see p.47 "Procedure for Sending E-mail".
- r The file stored when simultaneously storing file and sending file by e-mail cannot be resent in the E-mail screen. To resend the file, select the file in the Select Stored File screen and send it. See p.81 "Sending Stored Files by E-mail or Scan to Folder, or Delivering".

- 1** Place the original, and then adjust the settings for original size and orientation if required.

Reference

p.35 "Setting Originals"

- 2** Make the scan settings.
- 3** Select the destination.
- 4** Specify the sender and a subject if necessary.
- 5** Press [Store File].



- 6** Make sure [Send & Store] is selected.



- 7** Set file information if necessary.

Reference

p.75 "Specifying file information"

- 8** Press [OK].

- 9** Press the [Start] key.

Checking the Status of E-mail

The status of the last 100 sendings can be checked. For every new sending record after 100, the oldest record is deleted.

Note

When **[Print & Delete Scanner Journal]** is set to **[Delete all after printing]**, the whole journal is printed when the number of records reaches 100.

Items that can be checked

- **Date/Time**
The date and time the e-mail was sent or the date which "Error" or "Canceled" is confirmed is displayed.
- **Destination**
A used sending function (e-mail, Scan to Folder, or delivery function) is displayed with an icon.
When multiple destinations were selected, the first selected destination is displayed.
- **Sender**
- **File Name**
The file name is displayed only when storing a file and sending e-mail are performed at the same time.
- **Status**
Either of the following status is displayed: "Done", "Sending", "Waiting", "Error", or "Canceled".

1 Press **[Scanned Files Status]** on the screen for sending e-mail.



2 Check the displayed records.

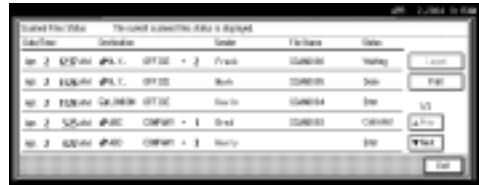

Note

- One screen shows the records for five sending operations. Use **[▲ Prev.]** or **[▼ Next]** to scroll through the screen.
- When the status of a file is waiting, the sending can be stopped by selecting that file, and then pressing **[Cancel]**.
- Press **[Print]**, and the whole journal is printed.

3 Press **[Exit]**.

The display returns to the screen for sending e-mail.

5. Sending Scan File by Scan to Folder

Scan file can be sent to the folders of the FTP server or the shared folders of Windows. This chapter explains the preparation for sending file by Scan to Folder, various display screens, procedures for sending, and how to check the sending result when this function is used.

Preparation for Sending by Scan to Folder

To send by Scan to Folder, the preparation described below is required.

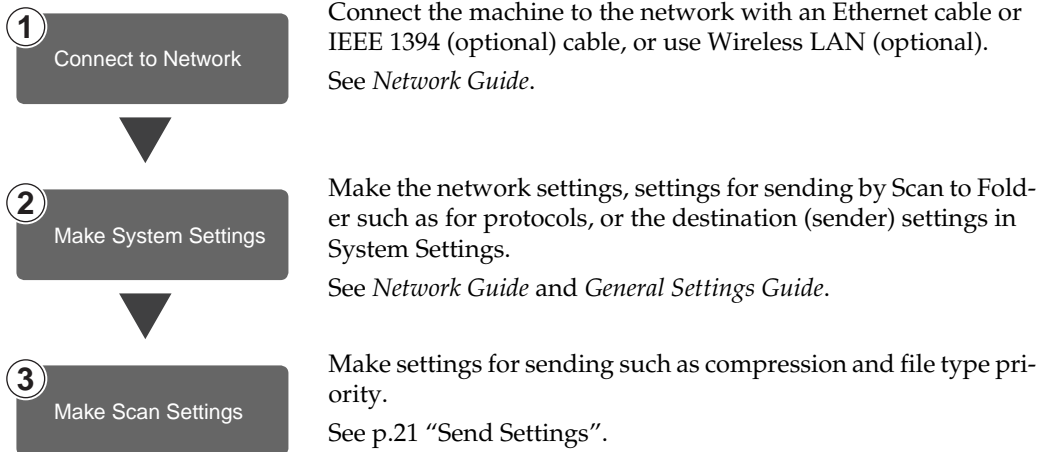

Sending files using SMB protocol is available only under the environment of NetBIOS over TCP/IP. Sending files using SMB protocol is not available under the NetBEUI environment.

Scan to Folder Screen

The screen when using the machine for Scan to Folder is as shown.

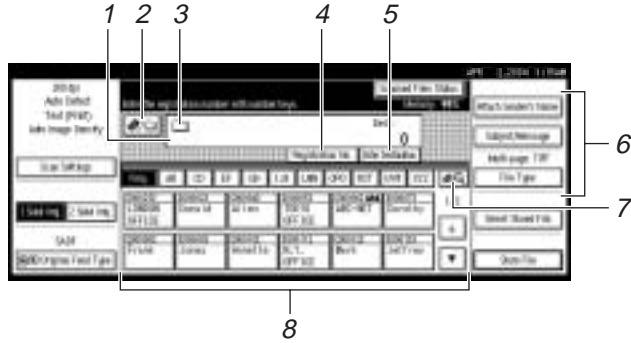

5

1. Destination field

The selected destination is shown here. If multiple destinations are selected, the destinations are displayed in the order they were selected by pressing [**▲ Prev.**] or [**▼ Next**].

Note

r Pressing the [**Check Modes**] key lets you check the selected destinations.

2. [] E-mail/Scan to Folder

Press to switch the Scan to Folder function to the e-mail function. You can send file to the destinations for both Scan to Folder and e-mail at the same time.

3. Scan to Folder icon ()

Shows that the screen for sending by Scan to Folder is displayed.

4. [**Registration No.**]

Press to specify a destination using a five-digit registration number.

5. [**Enter Destination**]

When specifying a destination that is not listed, press [**Enter Destination**], and then enter the destination with the soft keyboard.

6. [**Attach Sender's Name**] [**Subject/Message**] [**File Type**]

Set the sender, subject, and message of the scan file to be sent.

Set the file type and file name of the scan file to be sent.

Important

r When the scan file is sent to the destinations for both e-mail and Scan to Folder at the same time, the subject and message are sent to the destination for e-mail only.

7. [] Switch Destination List/Search/Switch Title

Press to switch a destination from the delivery server list to the destination list of this machine, to search for a destination, or to switch the titles.

8. Destination List

Displays the destinations programmed in the delivery server or this machine.

Note

r When the entire list does not fit on one screen, [**▲**] or [**▼**] can be used to scroll through the display.

r Group destinations are denoted by this symbol ()

Sending Scan File by Scan to Folder

Procedure for Sending by Scan to Folder

Scan file is sent after specifying scan settings and destinations.

- 1 Press the **[Scanner]** key.

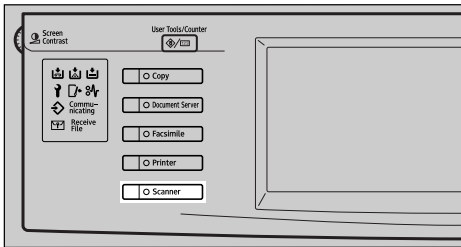

- 2 If user codes are set, enter a user code with the number keys, and then press the **[#]** key.

The Scanner Function screen appears.

Reference

For information about user codes, see *General Settings Guide*.

- 3 Make sure that no previous settings remain.

Note

If a previous setting remains, press the **[Clear Modes]** key.

- 4 Place the original in the machine, and then adjust the scan settings and settings for orientation and pageflow if necessary.

To make the scan settings, recall stored settings or make the settings individually.

Reference

p.16 "Scan Settings"

p.35 "Setting Originals"

Recalling stored scan settings

- A Press the **[Program]** key.
- B Select a program of scan settings.



The settings of the selected program are applied.

Making the settings individually

- A Press **[Scan Settings]**.
- B Select items such as resolution and original size, and then change their settings.



Scan settings can be made in the same way as Default Scan Settings. See p.16 "Default Scan Settings".

- C Press **[OK]**.

5 If the network delivery scanner screen appears, switch to the screen for Scan to Folder.

A Press [F5].

B Press [Switch Destination List].



C Press [E-mail].



D Press [Exit].

The E-mail screen appears.

E Press [F5].

The Scan to Folder screen appears.

6 Specify the destination folder.

To specify the destination folder, you can select it from the list, select it by specifying a registration number, enter the path for the folder of the client computers on the same network directly, specify the folder in the FTP server, or select the destination from the client computers on the same network.

When selecting a destination folder from the list

A Press the title for the destination folder. The destination folders for that title are displayed.

If the folder is not displayed, press [▲] or [▼] to display the other folders.



B Select the destination folder to which the scan file is to be sent.



The selected folder is highlighted and also is displayed in the destination field at the top of the screen.

Note

r If a protection code has been set for the folder, a screen for entering the protection code appears.

C To select more destination folders, repeat step B.

Note

r To deselect a destination, press the destination once more, or press [▲ Prev.] or [▼ Next] to display the destination in the destination field, and then press the [Clear/Stop] key.

Using a registration number to select a destination folder

- A Press **[Registration No.]**.
- B Use the number keys to enter the five-digit registration number that has been assigned to a destination folder.

If the entered number is less than five digits long, press the **[#]** key after the last number.

Example: To enter 00003

Press the **[3]** key, and then press the **[#]** key.



Note

- r If a protection code has been set for the folder, a screen for entering the protection code appears.

- C To select more destination folders, repeat step B.

Note

- r To deselect a destination, press **[▲ Prev.]** or **[▼ Next]** to display the destination in the destination field, and then press the **[Clear/Stop]** key.

Manual entry of a path for the destination folder of the client computers on the same network

- A Press **[Enter Destination]**.
- B Press **[SMB]**.



- C Press **[Manual Input]** on the right side of the path field.

The soft keyboard is displayed for entering the path for the folder.

- D Enter the path for the folder.

Note

- r This is an example of entering a pass to send to the folder "user" of the computer "desk01". \\desk01\user
- r An IP address can be also entered if you use the following operating systems are available: Windows 98/Me, Windows XP, Windows 2000, Windows NT 4.0.

Reference

For information about how to enter characters, see *General Settings Guide*.

- E Press **[OK]**.
- F If entering a user name to log on is required, press **[Manual Input]** on the right side of the user name field.

The soft keyboard is displayed for entering the user name field.

- G Enter the user name.
- H Press **[OK]**.

I If entering a password to log on is required, press **[Manual Input]** on the right side of the password field.

The soft keyboard is displayed for entering a password.

J Enter a password.

K Press **[OK]**.

L Press **[Connection Test]**.



A connection test is performed to check whether the specified folder exists.

Note

r To change the path for the folder that has been entered, press **[Change]** located on the left side of the destination field. Enter a path for the folder properly, and then press **[OK]**.

r Pressing the **[Check Modes]** key on the control panel lets you check the list of selected destinations.

r The connection test sometimes takes time.

r **[Connection Test]** can not be pressed right after **[Cancel]** was pressed during the connection test.

r Though the connection test is succeeded, the machine sometimes fails in the file transfer, when the shared folder lacks writing authority or when there is no space in the hard disk.

M To enter more destinations, repeat steps A to L.

Note

r To deselect a destination, press **[▲ Prev.]** or **[▼ Next]** to display the destination in the destination field, and then press the **[Clear/Stop]** key.

N Press **[OK]**.

Specifying a folder in the FTP server

A Press **[Enter Destination]**.

B Press **[FTP]**.



A confirmation message for changing the protocol appears.

C Press **[Yes]**.

D Press **[Manual Input]** on the right side of the server name field.



The soft keyboard is displayed for entering the server name.

E Enter a server name.

Note

r An IP address can be also entered.

F Press **[OK]**.

- G Press **[Manual Input]** on the right side of the path field.

The soft keyboard is displayed for entering the path for the folder.

- H Enter the path for the folder.

 **Note**

- r This is an example of entering a pass to send to the sub-folder "lib" in the folder "user". user\lib

 **Reference**

For information about how to enter characters, see *General Settings Guide*.

- I Press **[OK]**.

- J If entering a user name to log on is required, press **[Manual Input]** on the right side of the user name.

The soft keyboard is displayed for entering the user name.

- K Enter the user name.

- L Press **[OK]**.

- M If entering a password to log on is required, press **[Manual Input]** for password.

The soft keyboard is displayed for entering a password.

- N Enter a password.

- O Press **[OK]**.

- P To change the port number which is set in the initial scan setting, press **[Change]** on the right side of the Port No. field. Enter a port number using the number keys, and then press **[#]**.

- Q Press **[Connection Test]**.



A connection test is performed to check whether the specified folder exists.

 **Note**

- r To change a path for the folder that has been entered, press **[Change]** located on the left side of the destination field. Enter a path for the folder properly, and then press **[OK]**.

- r Pressing the **[Check Modes]** key on the control panel lets you check the list of selected destinations.

- r The connection test sometimes takes time.

- r **[Connection Test]** can not be pressed right after **[Cancel]** was pressed during the connection test.

- R To enter more destinations, repeat steps A to Q.

 **Note**

- r To deselect a destination, press **[▲ Prev.]** or **[▼ Next]** to display the destination in the destination field, and then press the **[Clear/Stop]** key.

- S Press **[OK]**.

Searching to select a destination folder from the network

A Press **[Enter Destination]**.



B Press **[SMB]**.



C Press **[Browse Network]** on the right side of the path field.

The client computers list on the same network appears.

Note

- r Workgroup names or domain names must be set properly to browse the network.
- r If the client computer you want to select is not displayed, press **[Up One Level]** to select other workgroups, and then you can search for the client computer.
- r The maximum number of client computers and shared folders displayed is 100.

D Select the client computer that has the destination folder.



The log on screen is displayed when the machine is required to authenticate the selected computer. Enter the user name and password correctly.

The folders list of the selected computer appears.

E Select the destination folder.

Note

- r When the selected folder has sub-folders, the sub-folders list appears.



F Press **[OK]**.

G If entering a user name to log on is required, press **[Manual Input]** on the right side of the user name field.

The soft keyboard is displayed for entering a user name.

H Enter a user name.

I Press **[OK]**.

J If entering a password to log on is required, press **[Manual Input]** on the right side of the password field.

The soft keyboard is displayed for entering a password.

K Enter a password.

L Press **[OK]** twice.

Searching to select a destination folder from the Destination List

A Press **[F2]**.



B Press **[Search by Dest. Name]**.



The soft keyboard is displayed for entering a user name.

C Enter part of the destination folder name.

Note

- r Enter the first character or characters of the destination name.
- r It is necessary to differentiate between capital and small letters.

Reference

For information about how to enter characters, see *General Settings Guide*.

D Press **[OK]**.

E Select a destination folder.



F Press **[Exit]**.

Checking selected destinations

A Use the destination field at the top of the screen to check which destinations are selected.

Note

- r When multiple destinations are selected, the selected destinations are displayed in the order they were selected by pressing **[▲ Prev.]** or **[▼ Next]**.
- r Pressing the **[Check Modes]** key on the control panel lets you check the list of selected destinations.

7 Select the file type if necessary.

A Press **[File Type]**.

B Select the file type of the file to be sent from the displayed types.



C Press **[OK]**.

8 Specify the file name of the file to be sent if necessary.

A Press **[File Type]**.

B Press **[File Name]**.

The soft keyboard is displayed for entering a file name.

C Enter a file name.

Note

- r The scan file is given a 21-digit (except the extension) file name which combines the time and date of scanning originals with a 4-digit page number. (Example : When one page is scanned in TIFF at 15.10 seconds, 3.30 p.m., 31 December, 2003, the file name is 200312311530150100001.tif)

D Press [OK].



E Press [OK].

9 Select a sender if necessary.

To specify a sender, you can select the sender from the list, enter the five-digit registration number of the sender with the number keys, and search for the sender and selecting it.

Note

- r When the sender name is specified in this step, it is displayed in the whole journal.
- r To prevent misuse of a sender name, we recommend you set a protection code for that sender name.
- r Be sure to select or enter a sender name. Otherwise **[Key Operator's E-mail Address]** is used as the sender name. See *General Settings Guide*.

When selecting a sender from the list

A Press [Attach Sender's Name].



B Select the sender.



Note

- r When a protection code has been set, a screen for entering the protection code appears after selecting the sender. Enter the protection code, and then press [OK]. When the protection code you entered is correct, the sender name is displayed.

C Press [OK].

Using a registration number to specify a sender name

A Press [Attach Sender's Name].



B Use the number keys to enter the five-digit registration number that has been assigned to a sender.

If the entered number is less than five digits long, press the **[#]** key after the last number.

Example: To enter 00002

Press the **[2]** key, and then press the **[#]** key.



Note

When a protection code has been set, a screen for entering the protection code appears after selecting the sender. Enter the protection code, and then press **[OK]**. When the protection code you entered is correct, the sender name is displayed.

C Press [OK].

Searching to select a sender

A Press [Attach Sender's Name].



B Press [OK].



C Press [User (Dest.) Name].



The soft keyboard is displayed for entering a sender name.

D Enter part of the sender name.

Note

- r Enter the first character or characters of the sender name.
- r It is necessary to differentiate between capital and small letters.

Reference

For information about how to enter characters, see *General Settings Guide*.

E Press [OK].

F Select the sender.



Note

When a protection code has been set, a screen for entering the protection code appears after selecting the sender. Enter the protection code, and then press **[OK]**. When the protection code you entered is correct, the sender name is displayed.

G Press [Exit].

H Press [OK].

10 Press the **[Start]** key.

Note

- r To interrupt scanning, press the **[Clear/Stop]** key or press **[Stop]** on the screen.
- r When using the Batch function or the SADF function, place the next original after the others have been scanned. See p.42 "Scanning Originals in Several Times".
- r A file beyond 2000 MB cannot be sent.

Simultaneous Storage and Sending by Scan to Folder

You can use Scan to Folder with the Document Server.

Scan file is stored in the Document Server at the same time the file is sent by Scan to Folder.

Note

- r This section explains mainly the operation for simultaneous storage and sending by Scan to Folder. For more information, see p.61 "Procedure for Sending by Scan to Folder".
- r The file stored when simultaneously storing file and sending file by Scan to Folder cannot be resent in the Scan to Folder screen. To resend the file, select the file in the Select Stored File screen and send it. See p.81 "Sending Stored Files by E-mail or Scan to Folder, or Delivering".

1 Place the original, and then adjust the settings for original size and orientation if required.

Reference
p.35 "Setting Originals"

2 Make the scan settings.

3 Select the destination.

4 Specify the sender name, subject, and message when storing a file and sending e-mail are performed at the same time.

5 Press **[Store File]**.



6 Make sure **[Send & Store]** is selected.



7 Set file information if necessary.

Reference
p.75 "Specifying file information"

8 Press **[OK]**.

9 Press the **[Start]** key.

Checking the Status of Scan to Folder

The status of the last 100 sendings can be checked. For every new sending record after 100, the oldest record is deleted.

Note

When **[Print & Delete Scanner Journal]** is set to **[Delete all after printing]**, the whole journal is printed when the number of records reaches 100.

v Items that can be checked

- **Date/Time**
The date and time the sending was requested or the date which "Error" or "Canceled" is confirmed is displayed.
- **Destination**
A used sending function (e-mail, Scan to Folder, or delivery function) is displayed with an icon.
When multiple destinations were selected, the destinations are displayed individually.
- **Sender**
The file name is displayed only when storing a file and sending e-mail are performed at the same time.
- **File Name**
- **Status**
Either of the following status is displayed: "Done", "Sending", "Waiting", "Error", or "Canceled".

- 1** Press **[Scanned Files Status]** on the screen for Scan to Folder.



- 2** Check the displayed records.



Note

- One screen shows the records for five sending operations. Use **[▲ Prev.]** or **[▼ Next]** to scroll through the screen.
- When the status of a document is waiting, the sending can be stopped by selecting that document, and then pressing **[Cancel]**.
- Press **[Print]**, and the whole journal is printed.

- 3** Press **[Exit]**.

The display returns to the screen for sending by Scan to Folder.

6. Using the Document Server Function

Scan file obtained by scanning originals can be stored in the hard disk of the machine using the Document Server, and the stored file can be used later. Using DeskTopBinder V2 Lite/Professional, stored file can be viewed, retrieved, or deleted with a client computer.

The stored file can also be viewed, downloaded, printed, or deleted using Web browser from a client computer.

Reference

For more information about using the Document Server, see *General Settings Guide*.

Important

- r A password can be set for every stored file in the Document Server. There is a fear that stored files with no password can be accessed by the user who uses DeskTopBinder. We recommend you should consider a security system such as setting a password that protects illegal accesses.
- r Scan file stored in the machine might be lost if some kind of failure occurs. The supplier shall not be responsible for any damage that might result from the loss of file. For long-term storage of files, we recommend the use of DeskTopBinder V2 Lite or DeskTopBinder V2 Professional (optional). For more information, please contact your local dealer.

Note

- r When a delivery server is added to the network, files stored in the Document Server can be delivered. You can store scan files in the Document Server and simultaneously deliver it with the network delivery scanner function, send it by e-mail, or send it by Scan to Folder. See p.81 “Sending Stored Files by E-mail or Scan to Folder, or Delivering”.

Storing Files

This section describes how to store files in the Document Server and how to specify file information for stored files.

Note

- r The files stored in the Document Server are deleted automatically after a certain number of days have passed. For information about making settings and changes, see *General Settings Guide*.
- r The theoretical maximum number of files that can be stored is 3,000 (1,000 pages per file). However, the actual maximum may be less depending on the space used by the copier function and other functions of the machine.
- r Stored file scanned using the scanner function cannot be printed from the control panel. Print the file after retrieving them, using DeskTopBinder V2 Lite/Professional.

Storage Procedure

Scan and store the file in the Document Server.

1 Press the **[Scanner]** key.

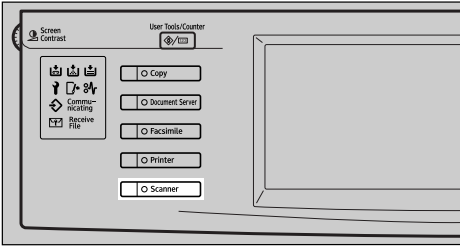

2 If the user codes are set, enter a user code with the number keys, and then press the **[#]** key.

The Scanner Function screen appears.

Reference

For information about the user codes, see *General Settings Guide*.

3 Make sure that no previous settings remain.

Note

If a previous setting remains, press the **[Clear Modes]** key.

4 Place the original in the machine, and then adjust the settings for original size and orientation if required.

Reference

p.35 "Setting Originals"

5 Make the scan settings.

To make the scan settings, recall the stored settings or make the settings individually.

Reference

p.16 "Scan Settings"

Recalling stored scan settings

A Press the **[Program]** key.

B Select a user program of scan settings.



The selected user program settings are applied.

Making settings individually

A Press **[Scan Settings]**.

B Select items such as resolution and original size and change their settings.



Scan settings can be made in the same way as Default Scan Settings. See p.16 "Default Scan Settings".

C Press **[OK]**.

6 Make the settings for storing scan files.

A Press **[Store File]**.



B Press [Store Only].**Note**

- r To store and deliver scan files, press **[Send & Store]**. See p.57 "Simultaneous Storage and Sending by E-mail", p.70 "Simultaneous Storage and Sending by Scan to Folder", or p.93 "Simultaneous Storage and Delivery".
- r **[Store Only]** cannot be pressed if even a single destination or sender is selected.

7 Specify file information.

Specify a user name, file name, and password for the file to be stored.

Reference

For more information about how to specify file information, see p.75 "Specifying file information".

A Press **[OK]** twice.

8 Press the [Start] key.**Note**

- r To abort the scanning process, press the **[Clear/Stop]** key or press **[Stop]** on the screen.
- r When using the SADF function, place the next original after the others have been scanned. See p.42 "Scanning Originals in Several Times".

Specifying file information

You can specify a user name, file name, and password for a stored scan file.

According to the settings made, you can search for files by user name or file name and you can prevent unauthorized persons from accessing the files.

Note

- r The file name can be up to 64 characters long. The user name can be up to 20 characters long. The first 16 characters are shown on the control panel. From a client computer with DeskTopBinder V2 Lite/Professional installed, you can view all the characters entered.

1 Press [Store File].

The File Information screen appears.

**2 Specify file information.****Specifying a user name****A Press [User Name].****Note**

- r If no user code is programmed on the Key Operator Tools tab in System Settings, the User Code screen does not appear. Instead, the Non-programmed Name screen appears. Enter any user name.

B Select the user name.

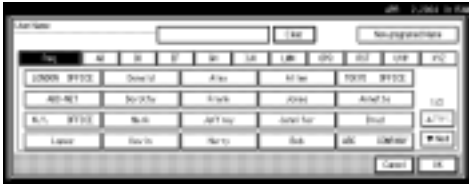

Note

r The user names shown here are names that were programmed on the Key Operator Tools tab in System Settings. To enter a name not shown here, press [**Non-programed Name**], and then enter the user name.

C Press [OK].



Specifying a file name

Scan files are automatically named SCAN0001, SCAN0002, etc. If necessary, you can change the file name.

A Press [File Name].

The soft keyboard is displayed for entering a file name.

B Enter the file name.

Reference

For information about how to enter characters, see *General Settings Guide*.

C Press [OK].

Specifying a password

When a password is specified, only a person who knows the password can view the file.

A Press [Password].

B Enter a four-digit password with the number keys.



C Press the [#] key.

Note

r To change the password, press [**Change**], and then enter a new one.

D Enter the same number as you entered in step B to verify.

E Press the [#] key.

F Press [OK].

Important

r Do not forget the password. If you forget it, consult the system administrator of the machine.

3 Press [OK] to return to the previous screen.



Viewing a List of Stored Files

From the list of stored files, you can delete the files stored in the Document Server or change the file information. To show the list of stored files, perform the following steps:

- 1 Press the **[Scanner]** key.

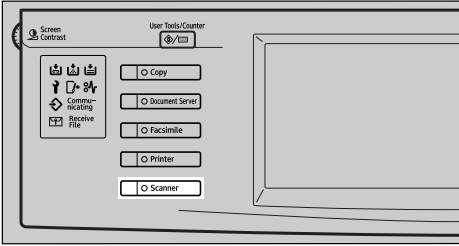

- 2 If user codes are set, enter a user code using the number keys, and then press the **[#]** key.

The Scanner Function screen appears.

Reference

For information about the user codes, see *General Settings Guide*.

- 3 The list of stored files is displayed.

A Press **[Select Stored File]**.



B Press **[Manage/Delete File]**.

Viewing the List

The list of stored files has the following elements.

✓ **When using the network delivery scanner function, e-mail, or Scan to Folder**

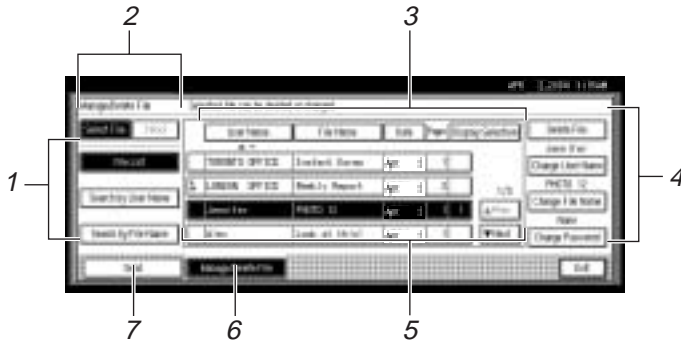

✓ **When displaying information of a selected stored file**

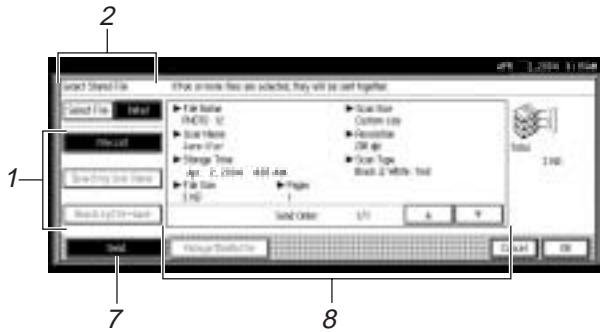

1. Keys for searching files

Switch to the screens for searching for a file by user name or file name, or to the screen for displaying all files.

2. Keys to switch to the information display

Use to switch between the stored file list and the detailed information of the selected file.

3. Keys for sorting files

Sort the files using the selected item. Select the same item once more for a reverse sort. However, the files cannot be sorted in reverse delivery order.

4. Keys for changing file information

Use for deleting the selected file or changing the user name, file name, or password.

5. List of stored files

The list of stored files is displayed.

Note

- r Stored files cannot be shown when a function other than the scanning function is being used.
- r If the file is not displayed, use [**▲ Prev.**] or [**▼ Next**] to scroll through the list.
- r For files which are password protected, a key symbol(Ⓜ) is shown to the left of the file name.

6. [Manage/Delete File]

Press to manage or delete files stored in the Document Server or to change file information etc..

7. [Send]

Press to send or deliver files stored in the Document Server. For more information, see p.81 "Sending Stored Files by E-mail or Scan to Folder, or Delivering".

8. Information of a selected stored file

Press **[Detail]** to display the information of a file after selecting the file from the file list.

Viewing a list of stored files in DeskTopBinder V2 Lite

The files stored in the Document Server are shown below using DeskTopBinder V2 Lite.

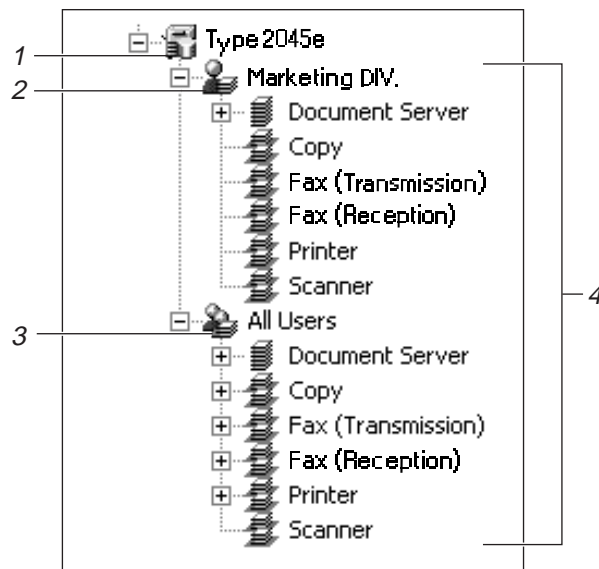
**1. Connected device name**

The files stored in the connected device are displayed on the desk tree divided into User name and All Users folders.

2. User name

Only the files stored with the same user name specified in the connected device properties are displayed. The files stored from the scanner are shown in the Scanner folder.

3. All Users

All files stored in the connected device are displayed.

4. Folder contents display

The files in the selected folder are displayed.

Searching for Files

You can search for files from the stored files using the user name or file name.

Searching by user name

- 1 On the screen with the list of stored files, press **[Search by User Name]**.
- 2 Select the user name to be used for the search.



Note

The user names shown here are names that were registered on the Key Operator Tools tab in System Settings. To enter a user name not shown here, press **[Non-programed Name]**, and then enter the name.

- 3 Press **[OK]**.

The search starts, and files whose user name starts with the entered string are displayed.



Searching by file name

- 1 On the screen with the list of stored files, press **[Search by File Name]**.

The soft keyboard is displayed for searching by file name.

- 2 Enter the file name to search for.

Note

It is necessary to differentiate between capital and small letters.

Reference

For information about how to enter characters, see *General Settings Guide*.

- 3 Press **[OK]**.

The search starts, and files whose name starts with the entered string are displayed.

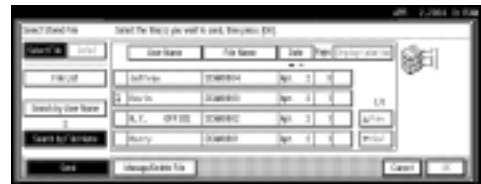

Sending Stored Files by E-mail or Scan to Folder, or Delivering

Files stored in the Document Server can be sent by e-mail or Scan to Folder, or delivered to the delivery server.

Note

- r This section explains how to select files to be sent or delivered. For more information about sending by e-mail, see p.47 “Procedure for Sending E-mail”. For more information about sending by Scan to Folder, see p.61 “Procedure for Sending by Scan to Folder”. For more information about delivering stored files, see p.87 “Delivering Scan File”.
- r When sending or delivering stored files, scan settings cannot be changed. The files are sent or delivered with the scan settings specified when they were stored in the Document Server.

1 Display the list of stored files by pressing [Select Stored File].

Reference

p.77 “Viewing a List of Stored Files”.

2 Select a file to be sent or delivered.

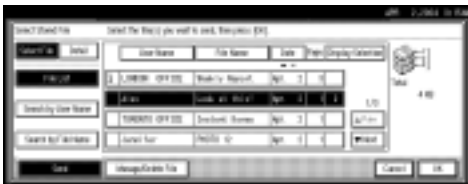

Note

- r When you select a password protected file, the Password screen appears. After you have entered the correct password and pressed [OK], the file will be selected.

3 To select multiple files, repeat step 2.

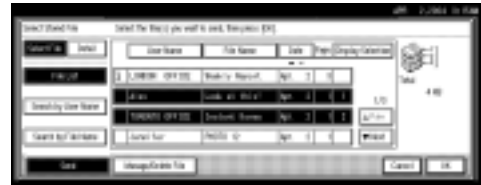

Note

- r You can select up to 30 files for one operation.
- r If you select multiple files, the files will be sent or delivered in the order they were selected.
- r If you press [Display Selection], the selected files will be shown in the order of delivery.

4 Press [OK].

The screen for sending or delivering appears.

5 Switch the Destination List if necessary.

6 Specify a destination to be sent or delivered.

7 Select the sender, subject, and message if necessary.

8 Press the [Start] key.

Managing Stored Files

Displaying and Downloading Stored Files Using a Web Browser

Using a Web browser in a client computer, you can display or download the files in the Document Server. When http:// (machine IP address) / is entered in the address bar of the Web browser in a client computer, the Stored Files List screen for the Document Server is displayed.

Reference

For displaying or downloading stored files using a Web browser, see *General Settings Guide*.

For more information about making settings for using a Web browser, see *Network Guide*.

For more information about functions for managing stored files using a Web browser, click **[Help]** on the upper-right corner of the displayed screen.

Deleting Files

You can delete files that are no longer needed.

Limitation

- r Files waiting for delivery cannot be deleted.

Reference

Using a Web browser (See *General Settings Guide*) from a client computer, you can also delete the files stored in the Document Server.

- 1** Display the list of stored files by pressing **[Select Stored File]**.

Reference

p.77 “Viewing a List of Stored Files”

- 2** Press **[Manage/Delete File]**.

The Manage/Delete File screen appears.

- 3** Select the file to be deleted.

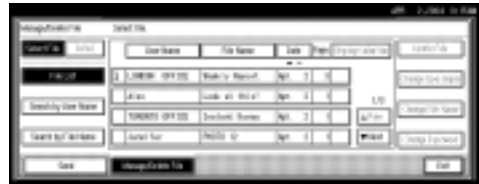

Note

- r Up to 30 files can be selected.
- r When you select a password protected file, the Password screen appears. Enter the correct password, and then press **[OK]**. When more than one file is selected, the Password screen appears each time a password protected file is selected.

- 4** Press **[Delete File]**.

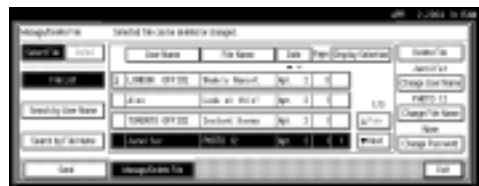

A confirmation message for file deleting appears.

- 5** Press **[Delete]**.

- 6** Press **[Exit]**.

Changing File Information

The information about files stored in the Document Server (user name, file name, and password) can be changed.

Limitation

- r Information about files waiting for delivery cannot be changed.

Reference

Using a Web browser (See *General Settings Guide*) from a client computer, you can change the information of files stored in the Document Server.

- 1** Display the list of stored files by pressing **[Select Stored File]**.

Reference

p.77 “Viewing a List of Stored Files”

- 2** Press **[Manage/Delete File]**.

- 3** Select the file for which you want to change the file information.



Note

- r When you select a password protected file, the Password screen appears. Enter the correct password, and then press **[OK]**.

- 4** Change the file information.

Changing the user name

A Press **[Change User Name]**.

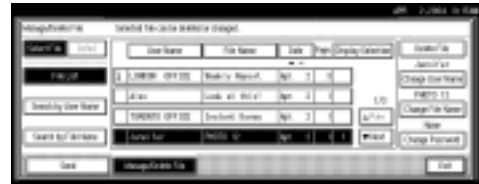

B Select the new user name.

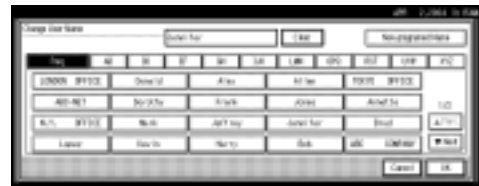

Note

- r The user names shown here are names that were registered on the Key Operator Tools tab in System Settings. To enter a user name not shown here, press **[Non-programmed Name]**, and then enter the user name.

C Press **[OK]**.

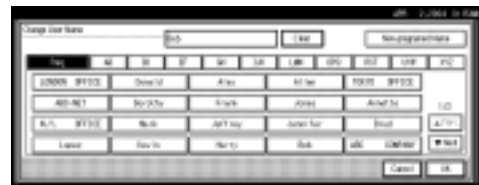

Changing the file name

A Press **[Change File Name]**.

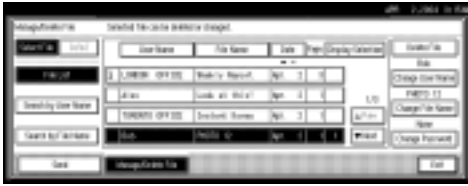

The soft keyboard is displayed for changing the file name.

B Enter the new file name.

Reference

For information about how to enter characters, see *General Settings Guide*.

C Press **[OK]**.

F Press **[OK]**.

Important

r Do not forget the password. If you forget it, consult the system administrator of the machine.

5 Make sure that the file information was changed as necessary, and press **[Exit]**.

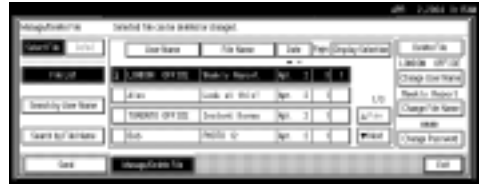

6

Changing the password

A Press **[Change Password]**.

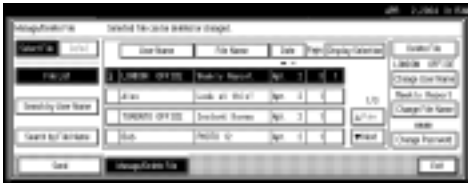

B Enter a new four-digit password using the number keys.



C Press the **[#]** key.

Note

r To change the password, press **[Change]**, and then enter a new one.

D Enter the same number as you entered in step B to verify.

E Press the **[#]** key.

7. Using the Network Delivery Scanner Function

Scan file can be sent to a specified destination using the network delivery scanner function. This chapter explains the preparation sequence, various display screens, delivery procedures, and how to check the delivery result when this function is used.

Important

A delivery server in which ScanRouter V2 Lite/Professional is installed is necessary to use the network delivery scanner function. Information about delivery destinations and senders must be registered first into the delivery server. Also, configure connected devices in **[Set I/O Device]** of ScanRouter V2 Administration Utility. For more information, see ScanRouter V2 Administration Utility Help.

Preparation for Delivering

To use the machine as a network delivery scanner, the preparation described below is required.

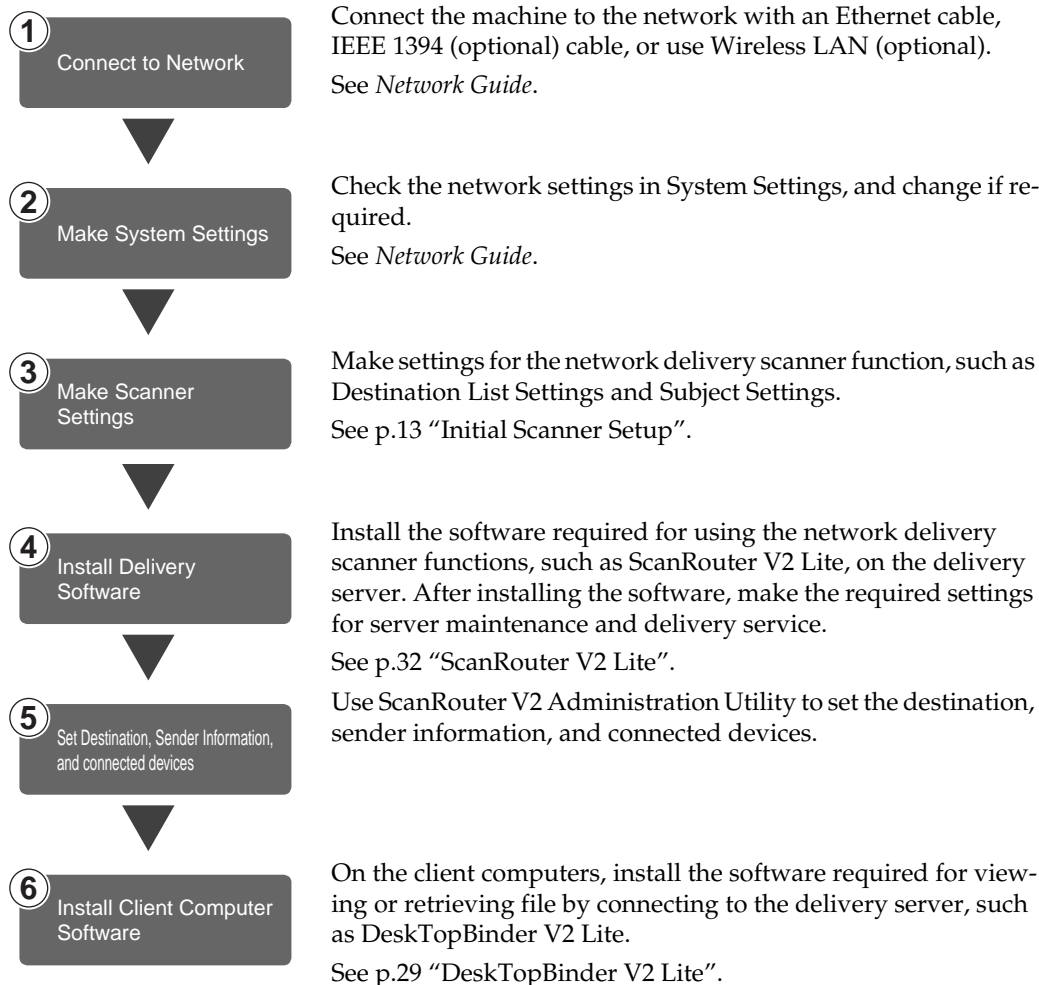

Network Delivery Scanner Screen

The screen when using the machine as a network delivery scanner is as shown.

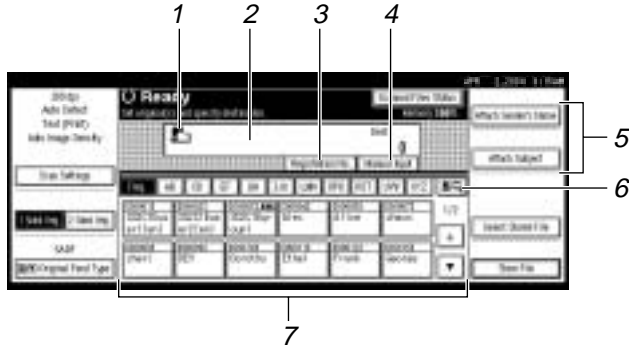

1. Network delivery scanner icon

Shows that the screen for network delivery scanner function is displayed.

2. Destination field

The selected destination is shown here. If multiple destinations are selected, the destinations are displayed in the order they were selected by pressing [**▲ Prev.**] or [**▼ Next**].

Note

r Pressing the [**Check Modes**] key lets you check the selected destinations.

3. [**Registration No.**]

Press to specify a destination using a five-digit registration number.

4. [**Manual Input**]

When specifying a destination that is not listed, press [**Manual Input**], and then enter the destination with the soft keyboard that is displayed. For information about sending e-mail from the delivery server, see the manual for ScanRouter V2. See p.i "Manuals for This Machine".

5. [**Attach Sender's Name**] [**Subject/Message**]

Set the sender, subject, and message of the document to be delivered.

6. [] **Switch Destination List/Search**

Press to switch a destination list from the delivery server to the destination list of this machine or to search by user name.

7. Destination list

Displays the destinations programmed in the delivery server or this machine.

Note

r When the entire list does not fit on one screen, [**▲**] or [**▼**] can be used to scroll through the display.

r Group destinations are denoted by this symbol ().

Delivering Scan File

Delivery Procedure

Scan file is delivered after scan settings and destinations are specified. If necessary, you can select a sender and a subject.

- 1 Press the **[Scanner]** key.

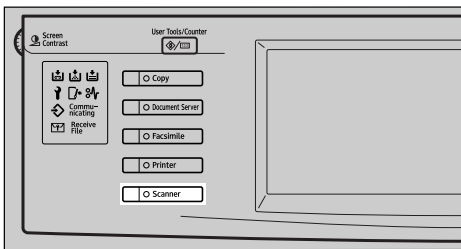

- 2 If user codes are set, enter a user code with the number keys, and then press the **[#]** key.

The Scanner Function screen appears.

Reference

For information about the user codes, see *General Settings Guide*.

- 3 Make sure that no previous settings remain.

Note

If a previous setting remains, press the **[Clear Modes]** key.

- 4 Place the original in the machine, and then adjust the scan settings and settings for orientation and pageflow if necessary.

To make the scan settings, recall stored settings or make the settings individually.

Reference

p.16 "Scan Settings"

p.35 "Setting Originals"

Recalling stored scan settings

- A Press the **[Program]** key.
- B Select a program of scan settings.

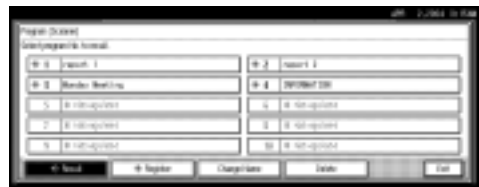

The settings of the selected program are applied.

Making settings individually

- A Press **[Scan Settings]**.
- B Select items such as resolution and original size, and then change their settings.



Scan settings can be made in the same way as Default Scan Settings. See p.16 "Default Scan Settings".

- C Press **[OK]**.
- 5 If the E-mail screen appears, switch to the screen for network delivery scanner.
 - A Press **[E-mail]**.

B Press [Switch Destination List].



C Press [Delivery Server].



D Press [Exit].

The Network Delivery Scanner screen appears.

6 Specify the destination.

To specify a destination, you can select it from the list, specifying a registration number, select it after search for it, or directly enter the e-mail address.

Note

When using ScanRouter V2 Lite/Professional, the destination list is updated automatically.

When selecting a destination from the list

A Press the title for the destination. The destinations for that title are displayed.

If the destination is not displayed, press [▲] or [▼] to display the destination.



Note

The destination titles are programmed in the delivery server.

B Select the destination to which the scan file is to be delivered.



The selected destination is highlighted and also is displayed in the destination field at the top of the screen.

C To select more destinations, repeat step B.

Note

To deselect a destination, press the destination once more, or press [▲ Prev.] or [▼ Next] to display the destination in the destination field, and then press the [Clear/Stop] key.

Using a registration number to select a destination

A Press [Registration No.].

B Use the number keys to enter the five-digit registration number that has been assigned to a destination.

If the entered number is less than five digits long, press the [#] key after the last number.

Example: To enter 00009
Press the **[9]** key, and then
press the **[#]** key.



C To select more destinations, repeat step B.

Note

- r To deselect a destination, press **[▲ Prev.]** or **[▼ Next]** to display the destination in the destination field, and then press the **[Clear/Stop]** key.

Searching to select a destination

A Press [F4].



B Press [Search Address Book].



C Press [Search by Dest. Name].

Note

- r When using ScanRouter V2 Professional, it is possible to search by comments.

The soft keyboard is displayed for entering a name.

D Enter part of the destination name.

Note

- r Enter the first character or characters of the destination name.
- r It is necessary to differentiate between capital and small letters.

Reference

For information about how to enter characters, see *General Settings Guide*.

E Press [OK].

F Select a destination.

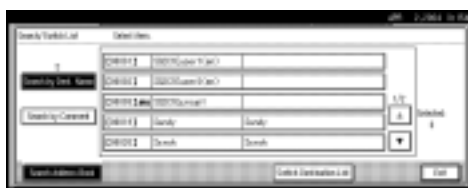

G Press [Exit].

H Press [OK].

Manual entry of a destination

Note

- r When using ScanRouter V2 Professional, it is possible to enter the destination e-mail address directly. In advance, you must make settings for sending e-mail with ScanRouter V2 Professional.

A Press [Manual Input].

The soft keyboard is displayed for entering a destination (e-mail address).

B Enter the destination.

Note

- r Enter the e-mail address of the destination when sending via the delivery server.
- r It is possible to use letters, numbers, and periods. The symbols ()\,;:" cannot be used.

Reference

For information about how to enter characters, see *General Settings Guide*.

C Press [OK].

D To enter more destinations, repeat steps A to C.

Note

- r To deselect a destination, press [**▲ Prev.**] or [**▼ Next**] to display the destination in the destination field, and then press the [**Clear/Stop**] key.
- r Pressing the [**Check Modes**] key on the control panel lets you check the list of selected destinations.

Checking selected destinations

A Use the destination field at the top of the screen to check which destinations are selected.

Note

- r When multiple destinations are selected, the selected destinations are displayed in the order they were selected by pressing [**▲ Prev.**] or [**▼ Next**].
- r Pressing the [**Check Modes**] key on the control panel lets you check the list of selected destinations.

7 Specify the sender (scan file delivery source) if necessary.

To specify a sender, you can select the sender from the list, enter the five-digit registration number of the sender with the number keys, and search for the sender and selecting it.

Note

- r When a sender has been specified, this information is added to the scan file. Select a sender from the senders programed in the delivery server.

When selecting a sender from the list

A Press [Attach Sender's Name].



B Select the sender.



The selected sender and its registration number are displayed.

Note

- r When using ScanRouter V2 Professional, [**Return Receipt**] is displayed when a sender is selected.

- r When **[Return Receipt]** is selected, an e-mail notifying that the file has been read by the destination party is sent to the sender selected here. To use **[Return Receipt]**, it is necessary to make settings such as the e-mail address in advance in ScanRouter V2 Professional.



C Press **[OK]**.

Using a registration number to specify a sender name

A Press **[Attach Sender's Name]**.



- B Use the number keys to enter the five-digit registration number that has been assigned to a sender.

Example: To enter 00007

Press the **[7]** key, and then press the **[#]** key.



Note

- r When using ScanRouter V2 Professional, **[Return Receipt]** is displayed when a sender is selected.
- r When **[Return Receipt]** is selected, an e-mail notifying that the file has been read by the destination party is sent to the sender selected here. To use **[Return Receipt]**, it is necessary to make settings such as the e-mail address in advance in ScanRouter V2 Professional.



C Press **[OK]**.

Searching to select a sender

A Press **[Attach Sender's Name]**.



B Press **[#]**.



C Press [User (Dest.) Name].



The soft keyboard is displayed for entering a sender name.

D Enter part of the sender name.

Note

- Enter the first character or characters of the sender name.
- It is necessary to differentiate between capital and small letters.

Reference

For information about how to enter characters, see *General Settings Guide*.

E Press [OK].

F Select a sender.



G Press [Exit].

H Press [OK].

8 Specify a subject if necessary.

Note

- When a subject has been specified, this information is added to the scan file.
- When ScanRouter V2 Professional is used to send documents using e-mail, the subject is automatically entered as the message subject.

To specify a subject name, you can select it from the list, enter it directly, or combine selecting and entering it.

Subject name to select from the list must be registered in System Settings in advance. See *Network Guide*.

Subject name can be entered up to 64 characters.

The operation to specify a subject name "[Urgent] New product appearance" is explained as an example here.

A Press [Attach Subject].



B Press a subject [Urgent].

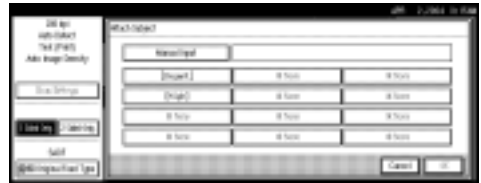

C Press [Manual Input].

The soft keyboard is displayed for entering a subject.

D Enter the subject "New product appearance".

Reference

For information about how to enter characters, see *General Settings Guide*.

E Press [OK] twice.

9 Press the **[Start]** key.

 **Note**

- r To interrupt scanning, press the **[Clear/Stop]** key or **[Stop]** on the screen.
- r When using the SADF or Batch function, place the next original after the others have been scanned. See p.42 “Scanning Originals in Several Times”.

Simultaneous Storage and Delivery

You can use the network delivery scanner function with the Document Server.

Scan file is stored in the Document Server at the same time the file is delivered.

 **Note**

- r This section explains mainly the operation for simultaneous delivery and storage. For more information, see p.87 “Delivering Scan File”.

1 Place the original, and then adjust the settings for original size and orientation if required.

 **Reference**

p.35 “Setting Originals”

2 Make the scan settings.

3 Select the destination.

4 Specify the sender name and a subject if necessary.

5 Press **[Store File]**.



6 Make sure **[Send & Store]** is selected.



7 Set file information if necessary.

 **Reference**

p.75 “Specifying file information”

8 Press **[OK]**.

9 Press the **[Start]** key.

Checking the Status of Delivery

The status of the last 100 deliveries can be checked. For every new delivery record after 100, the oldest record is deleted.

Note

When **[Print & Delete Scanner Journal]** is set to **[Delete all after printing]**, the whole journal is printed when the number of records reaches 100.

Items that can be checked

- **Date/Time**
The date and time the delivery was requested or the date which "Error" or "Canceled" is confirmed is displayed.
- **Destination**
A used sending function (e-mail, Scan to Folder, or delivery function) is displayed with an icon.
When multiple destinations were selected, the first selected destination is displayed.
- **Sender**
- **File Name**
The file name is displayed only when storing a file and sending e-mail are performed at the same time.
- **Status**
Either of the following status is displayed: "Done", "Sending", "Waiting", "Error", or "Canceled".

1 Press **[Scanned Files Status]** on the **Network Delivery Scanner** screen.



2 Check the displayed records.

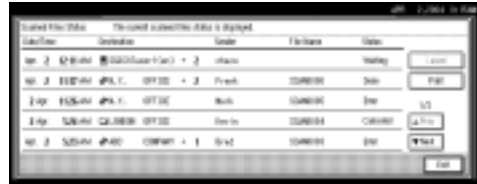

Note

- One screen shows the records for five delivery operations. Use **[▲ Prev.]** or **[▼ Next]** to scroll through the screen.
- When the status of a file is waiting, the delivery can be stopped by selecting that file, and then pressing **[Cancel]**.
- Press **[Print]**, and the whole journal is printed.

3 Press **[Exit]**.

The display returns to the **Network Delivery Scanner** screen.

8. Using the Network TWAIN Scanner Function

This chapter describes the operations for scanning originals with the network TWAIN scanner using DeskTopBinder V2 Lite. In addition, the preparation for using the network TWAIN scanner and some functions of the TWAIN driver are introduced.

Preparation for Using the Network TWAIN Scanner

To use the machine as a network TWAIN scanner, the preparation described below is required.

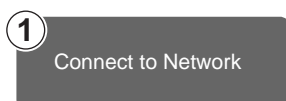

Connect the machine to the network with an Ethernet cable, IEEE 1394 (optional) cable, or use Wireless LAN (optional).
See *Network Guide*.

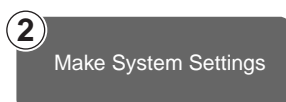

Check the network settings in System Settings, and change if required.
See *Network Guide*.

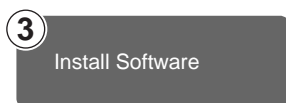

On the client computers, install the software required for using the network TWAIN scanner functions, such as a TWAIN driver and DeskTopBinder V2 Lite.
See p.27 “Software for Using a Network TWAIN Scanner”.

Scanning Originals

This section explains how to scan originals using the network TWAIN scanner function.

1 Start **DeskTopBinder V2 Lite**, and then select the scanner driver.

A On the **[Start]** menu, point to **[Program]**, point to **[DeskTopBinder V2]**, and then click **[DeskTopBinder V2]**.

B Click **[Scanner Settings]** on the **[Tools]** menu.

If the scanner is already selected, no scanner settings are necessary. Check the settings in the **[File format for scanned image(s)]** area, and then proceed to step E.

C Click **[Select Scanner Driver...]**.

D Select the name of the machine you want to use in the list, and then click **[Select...]**.

E Click **[OK]**.

2 Place the original in the scanner.

 **Reference**

p.35 "Setting Originals"

3 Make the scan settings.

A On the **[File]** menu, point to **[Add Document]**, and then click **[Scan]**.

The TWAIN driver starts.

After a short while, the dialog box of the TWAIN driver that operates the scanner appears. This dialog box is called the Scanner Properties dialog box.

Note

- r The name of the scanner currently being used is shown on the title bar of the dialog box. When multiple machines are connected, make sure that the indicated machine is the machine you want to use. If it is different, click **[Select Scanner]** to select the scanner again.
- r If the machine you want to use is not displayed in the list, make sure that the IP address is configured and that the machine is correctly connected to the network. If the machine is still not displayed in the list after confirming the above, consult with your network administrator.
- B Depending on the type of original or the objective for scanning, click the appropriate button in **[Mode]**.
 - **[Standard]** is suitable for scanning standard originals that are comprised of mainly text.
 - **[Photo]** is suitable for scanning originals that include photos, shaded illustrations, etc.
 - **[OCR]** is suitable for conversion processing with an OCR (Optical Character Reading) application after scanning the original.
 - **[Filing]** is suitable for use with filing applications, etc.

 **Note**

- r For advanced settings, click **[Detail]** to display the Detail window. For information about the Detail window, see TWAIN driver Help.

C According to the settings of [Document:] and [Orientation:], change the other setting of the [Document] group.

 **Reference**

p.41 “For a Network TWAIN Scanner”

For information about making settings for the **[Document]** group, see TWAIN driver Help.

When you want to configure the scanning area

When you do not configure the scanning area, the area scanned is the size specified in the **[Size:]** box.

A Click [Preview].

The original that was placed is scanned and the **[Preview]** dialog box appears. The scanning area in the preview is displayed within the broken lines.

B Configure the scanning area by dragging a border or a corner.

When reconfiguring the area, click  and drag one corner of the area towards or away from its opposite corner.

 **Note**

- r Depending on the scanning resolution, the area to be scanned may be subject to restrictions.

C Click [Close].

 **Note**

- r When an original placed in the ADF is previewed, place that original again.

4 Click [Scan].

When there are additional originals to scan, place the original, and then click **[Continue]**. When there are no more originals, click **[Complete]**.

5 Save the scan file in DeskTopBinder V2 Lite.

A On the [File] menu, click [Exit].

B Enter the file name, and then click [OK].

The image is stored in DeskTopBinder V2 Lite, and DeskTopBinder Viewer closes.

 **Editing and printing scan files**

With DeskTopBinder V2 Lite, it is possible to edit and print scan files. For more information about how to edit and print, see DeskTopBinder V2 Lite Help.

Functions of the TWAIN Driver

The following is an introduction to the various functions of the TWAIN driver:

Reference

For more information about these functions or other functions, see TWAIN driver Help.

v Automatic Tilt Correction

This function automatically corrects character strings that were scanned slanted.

v Printing to the Image

This function allows you to imprint dates, page numbers, or your favorite characters on a scan file. You can also change the fonts of the imprints as well as change the ascending order of images to a descending order.

v Scanning Mode Registration

This function allows you to register other scanning configurations that are often used as scanning modes besides the already pre-installed ones. After registration, you can quickly scan with these scanning configurations.

Relationship between Resolution and File Size

Resolution and scan area are inversely related. The higher the resolution is set, the smaller the area that can be scanned. Conversely, the larger the scan area, the lower the resolution that can be set.

The relationship between the scanning resolution and the file size is shown below. If the file size is too large, the message “Exceeded max. data capacity. Check the scanning resolution.” appears on the control panel of the machine. Specify the scan size and resolution again.

! Limitation

- r Depending on the image compression level, the maximum image size will be limited.

When Using as E-mail, Scan to Folder, Document Server or Network Delivery Scanner

v When Text, Text/ Photo, or Photo is selected as the Scan Type

All combinations up to A3/297 × 432 mm (11 × 17 inches) and 600 dpi are possible.

v When Gray Scale is selected as the Scan Type

The originals can be scanned using combinations marked with m in the table.

	100 dpi	200 dpi	300 dpi	400 dpi	600 dpi
A3	m	m	m		
B4	m	m	m	m	
A4	m	m	m	m	
B5	m	m	m	m	m
A5	m	m	m	m	m
B6 *1	m	m	m	m	m
A6 *1	m	m	m	m	m
A7 *1	m	m	m	m	m
11 x 17	m	m	m		
Legal (8 ¹ / ₂ x 14)	m	m	m	m	
8 ¹ / ₂ x 13	m	m	m	m	

	100 dpi	200 dpi	300 dpi	400 dpi	600 dpi
Letter (8 ¹ / ₂ x 11)	m	m	m	m	
5 ¹ / ₂ x 8 ¹ / ₂	m	m	m	m	m

*1 The scanning size must be manually entered.

When Using as a Network TWAIN Scanner

Reference

To specify the scanning area or resolution when using the machine as a network TWAIN scanner, see TWAIN driver Help.

v When Binary or Halftone is selected as the Colors/ Gradations

The originals can be scanned using combinations marked with m in the table (Original orientation: .

	100 dpi	200 dpi	300 dpi	400 dpi	500 dpi	600 dpi	700 dpi	800 dpi	900 dpi	1000 dpi	1100 dpi	1200 dpi
A3	m	m	m	m	m	m						
B4	m	m	m	m	m	m						
A4	m	m	m	m	m	m	m	m				
B5	m	m	m	m	m	m	m	m	m			
A5	m	m	m	m	m	m	m	m	m	m	m	m
B6	m	m	m	m	m	m	m	m	m	m	m	m
A6	m	m	m	m	m	m	m	m	m	m	m	m
A7 *1	m	m	m	m	m	m	m	m	m	m	m	m
11x17	m	m	m	m	m	m						
Legal (8 ¹ / ₂ x14)	m	m	m	m	m	m	m					
8 ¹ / ₂ x13	m	m	m	m	m	m	m					
Letter (8 ¹ / ₂ x11)	m	m	m	m	m	m	m	m				
5 ¹ / ₂ x8 ¹ / ₂	m	m	m	m	m	m	m	m	m	m	m	m

*1 The scanning size must be manually entered.

v **When Gray Scale is selected as the Colors/ Gradations**

The originals can be scanned using combinations marked with m in the table (Original orientation: \square).

	100 dpi	200 dpi	300 dpi	400 dpi	500 dpi	600 dpi	700 dpi	800 dpi	900 dpi	1000 dpi	1100 dpi	1200 dpi
A3	m	m	m									
B4	m	m	m	m								
A4	m	m	m	m								
B5	m	m	m	m	m							
A5	m	m	m	m	m	m	m					
B6	m	m	m	m	m	m	m	m				
A6	m	m	m	m	m	m	m	m	m			
A7 ^{*1}	m	m	m	m	m	m	m	m	m	m	m	m
11x17	m	m	m									
Legal (8 ¹ / ₂ x14)	m	m	m	m								
8 ¹ / ₂ x13	m	m	m	m								
Letter (8 ¹ / ₂ x11)	m	m	m	m	m							
5 ¹ / ₂ x8 ¹ / ₂	m	m	m	m	m	m	m					

^{*1} The scanning size must be manually entered.

Relationship between File Type Specified and File Type Used When Sending E-mail

The relationship between the file type specified when scanning originals and the file type converted into when sending e-mail or storing files is shown below by scan type.

File type specified	Single page	Multi page	
Scan type	TIFF/JPEG	TIFF	PDF
Text (Print)	TIFF	Multi-page TIFF	PDF
Text (OCR)			
Text/ Photo			
Photo			
Gray Scale	TIFF (Non-compression) / JPEG (Compression) *1	Multi-page TIFF (Non-compression) / PDF	

*1 When Gray Scale is used, the file format is converted to JPEG when **[Standard]**, **[High]**, or **[Low]** is selected for **[Compression (Gray Scale)]** in **[Scan Settings]**, and TIFF when **[Off]** is selected.

 **Note**

- r Files are stored in single-page style. When sending files by e-mail, you can select single-page style or multi-page style.
- r When multi-page TIFF is specified for the files saved in JPEG format, they are automatically changed to PDF.

Max. Number of Addresses Which Can Be Specified and Files Which Can Be Stored

	E-mail	Scan to Folder	Delivery Server
The number of addresses which can be specified at a time when sending	500 ^{*1} ^{*2}	50 ^{*1}	500 ^{*5}
	When sending e-mail and sending by Scan to Folder at the same time: 550 ^{*1} ^{*3}		
The number of addresses which can be registered in the list	2000		See the manuals for ScanRouter V2 Lite/Professional.
The max. number of files which can be stored	3000 ^{*4}		
The max. number of pages which can be stored	9000 ^{*4}		
The max. number of pages which can be stored as a single file	1000		

^{*1} There is a limitation to the number of addresses to specify in the following 1-4 case.

- ① The number of addresses to enter directly for sending e-mail: 65
- ② The number of addresses to enter directly for sending by Scan to Folder: 50
- ③ The number of addresses to search and specify from the LDAP server: 65
- ④ The number of addresses to specify combining with above 1, 2, and 3: 65

^{*2} When specifying 65 addresses to enter directly, the remainder of address should be specified from the registered ones within 435 addresses.

^{*3} When sending e-mail and sending by Scan to Folder at the same time, the address of e-mail cannot be specified over 500, and the address for Scan to Folder cannot be specified over 50.

^{*4} It is the number including the files which is stored using not only the Scanner function, but the copy function, the facsimile function, the Document Server function, and the printer function.

^{*5} The maximum number of addresses which can be specified varies depending on the software you use, ScanRouter V2 Lite/Professional. For more information, see the manuals for ScanRouter V2 Lite/Professional.

Note

- r Sometimes the machine cannot store or send files to the maximum number depending on the files and originals.

Troubleshooting

This section contains advice on what to do if you have problems scanning an original, or if the network delivery scanner or e-mail function does not work. Various messages that may appear on the control panel or client computer are listed, along with causes and solutions.

When Scanning Is Not Performed as Expected

Problems	Causes and solutions
No image results from scanning.	The original was placed with the front and back reversed. When the original is placed directly on the exposure glass, the side to be scanned must face down. When the original is fed via the ADF, the side to be scanned must face up. See p.35 "Setting Originals".
The image is distorted or out of position.	<ul style="list-style-type: none"> The original was moved during scanning. Do not move the original during scanning. The original was not pressed flat against the exposure glass. Make sure that the original is pressed flat against the exposure glass.
The scanned image is dirty.	The exposure glass or the exposure glass cover is dirty. Clean these parts. See <i>General Settings Guide</i> .
The scanned image is upside down.	The original was placed upside down. Place the original in the correct orientation. See p.35 "Setting Originals".

When the Delivery Function Does Not Work

Problems	Causes and solutions
The delivery scanner function screen is not displayed.	<ul style="list-style-type: none"> If the network TWAIN scanner screen appears when the machine is switched to scanner mode, press [Exit] to switch to the network delivery scanner screen. If the display does not switch from network TWAIN scanner to network delivery scanner, the delivery scanner settings are not correct. See p.13 "Scanner Features", and then make the appropriate settings.

When Stored Files Cannot Be Accessed



Problems	Causes and solutions
The stored file is locked and is not accessible.	The stored file with the protecting function is locked because the wrong password was entered ten times. For information about how to unlock the file, see "8. Security" <i>General Settings Guide</i> .





When an Error Message Appears on the Control Panel

 **Note**

r If an error message that is not included in this section appears, turn off the main power switch of the machine, and then turn it on again. If the message still appears, note the content of the message and the error number (if listed in the table), and contact your service representative. For information about how to turn off the main power switch, see *General Settings Guide*.

Message	Causes and solutions
Cannot cancel sending certain file(s). To confirm the result, check [Scanned Files Status].	Only files in waiting can be canceled. Files with a delivery status of successful or other result cannot be canceled.
Cannot detect original size. Select scan size.	<ul style="list-style-type: none"> • Place the original correctly. • Specify the scan size. • When placing an original directly on the exposure glass, the lifting/lowering action of the ADF triggers the automatic original size detection process. Lift the ADF by more than 30 degrees.
Cannot enter manually more than nnn destinations at the same time.  Note r "nnn" in the message represents changeable number.	When there are nnn or more destinations for a delivery or an e-mail, split the destinations into two or more groups.
Cannot find the specified path. Please check the settings.	Check whether the computer name and the folder name for the destination are correct.
Cannot log on with the entered user name or password.	Make settings correctly for the user name and the password for the authentication.
Cannot select over 30 files at the same time.	To deliver more than 31 stored files, divide the files and perform the operation several times.
Cannot specify more than 500 destinations at the same time.	When there are 500 or more destinations for a delivery or an e-mail, split the destinations into two or more groups.
Cannot specify more than 50 folders at the same time.	When there are 50 or more destinations for Scan to Folder, split the destinations into two or more groups.

Message	Causes and solutions
Captured file exceeded max. number of pages per file. Cannot send the scanned data.	The maximum number of pages which can be stored as a single file is 1000. Reduce the number of pages and send them again.
Connection with LDAP server has failed. Check the server status.	A network error has occurred and connection has failed. Try the operation once more. If the message is still shown, the network may be crowded. Check the information of System Settings.
Entered protection code for destination is incorrect. Please re-enter.	Make sure the protection code is correct, and then enter it again.
Exceeded max. data capacity. Check the scanning resolution, then press Start again.	Specify the scan size and resolution again. Note that it may not be possible to scan very large originals at a high resolution. See p.99 "Relationship between Resolution and File Size".
Exceeded max. data capacity. Check the scanning resolution, then reset nnn original(s).  Note r "nnn" in the message represents changeable number.	Specify the scan size and resolution again. Note that it may not be possible to scan very large originals at a high resolution. See p.99 "Relationship between Resolution and File Size".
Exceeded max. E-mail size. Sending E-mail has been cancelled. Check [Max. E-mail Size] in Scanner Features.	<ul style="list-style-type: none"> • Increase the size of [Max. E-mail Size]. • Set [Divide & Send E-mail] to [Yes (per Page)] or [Yes (per Max. Size)].
Exceeded max. file capacity. Delete the unnecessary stored files.	The maximum number of files that can be stored is 3000. Reduce the number of files or delete unneeded files.
Exceeded max. No. of search results which can be displayed. Max.: nnn  Note r "nnn" in the message represents changeable number.	Search again after changing the search conditions.
Exceeded max. number of alphanumeric characters.	Make sure the maximum number of characters which can be entered, and then enter it again.

Message	Causes and solutions
Exceeded max. number of alphanumeric characters for the path.	The maximum number of characters which can be entered for path is 128. Check the number of character you entered, and then enter it again.
Exceeded max. number of files which can be sent at the same time. Reduce the number of the selected files.	The number of files exceeded the maximum number possible. Reduce the number of files and send them again.
Exceeded max. number of files which can be used in Document Server at the same time.	Make sure the files stored by the other functions, and then delete unneeded files.
Exceeded max. number of pages per file. Do you want to store the scanned pages as 1 file?	The maximum number of pages per file is 1000. Specify whether to use the data or not. Scan the pages that were not scanned and store them as a new file.
Exceeded max. number of standby files. Try again after the current file is sent.	There are 100 files waiting in the sending queue for e-mail, Scan to Folder, or delivery function. Wait until files have been sent.
Exceeded max. number of stored files. Cannot send the scanned data as capturing files is unavailable.	The maximum number of files that can be stored in Document Server is 3000. Reduce the number of files or delete unneeded files.
Exceeded max. page capacity per file. Press [Send] to send the scanned data, or press [Cancel] to delete.	Because the number of pages has reached the maximum number that can be sent, the data up to this point is sent. Scan the remaining pages after transmission.
Exceeded time limit for LDAP server search. Check the server status.	A network error has occurred and connection has failed. Try the operation once more. If the message is still shown, the network may be crowded. Check the information of System Settings.
LDAP server authentication has failed. Check the settings.	Make settings correctly for the user name and the password for LDAP server authentication.
Load paper of the following sizes. Required: 11 x 17  8 1/2 x 14  8 1/2 x 11  8 1/2 x 11 	Load paper of the sizes listed in the message.

Message	Causes and solutions
Memory is full. Cannot scan. The scanned data will be deleted.	Because of insufficient hard disk space, the first page could not be scanned. Try one of the following measures: <ul style="list-style-type: none"> • Wait for a while, and then retry the scan operation. • Reduce the scan area or scanning resolution. • Delete unneeded stored files.
Memory is full. Press [Send] to send the current scanned data, or press [Cancel] to delete.	Because there is not enough free hard disk space in the machine for delivering or sending by e-mail while storing into the Document Server, only some of the pages could be scanned. Specify whether to use the data or not.
Memory is full. Scanning has been cancelled. Do you want to store the scanned data?	Because there is not enough free hard disk space in the machine for storing into the Document Server, only some of the pages could be scanned. Specify whether to use the data or not.
No HDD is available for this function. Cannot store. Set original and select the TWAIN settings from the PC.	Files can be stored with TWAIN by switching to the network TWAIN scanner function.
Original is being scanned by another function.	The machine is using another function such as copying. Retry scanning after the operation with the other function is completed.
Out of paper in.... Load paper of the following size.	Load paper in the tray indicated.
Output buffer is full. Sending the data has been cancelled. Please try again later.	Too many files are waiting to be delivered. Please try again after they have been delivered.
Selected file is currently in use. Cannot change file name.	The name of a file that is being edited with DeskTopBinder V2 Lite/Professional or that is waiting for delivery cannot be changed. Try the operation again after editing is finished or delivery is canceled.
Selected file is currently in use. Cannot change password.	The password of a file that is being edited with DeskTopBinder V2 Lite/Professional or that is waiting for delivery cannot be changed. Try the operation again after editing is finished or delivery is canceled.

Message	Causes and solutions
Selected file is currently in use. Cannot change user name.	The user name of a file that is being edited with DeskTopBinder V2 Lite/Professional or that is waiting for delivery cannot be changed. Try the operation again after editing is finished or delivery is canceled.
Selected file is currently in use. Cannot delete it.	A file that is being edited with DeskTopBinder V2 Lite/Professional or that is waiting for delivery cannot be deleted. Try the operation again after editing is finished or delivery is canceled.
Sender's name is not selected. Please specify sender's name.	A sender's name should be specified before sending e-mail. Send e-mail after specifying the sender's name.
Sending the data has failed. The data will be resent later.	A network error has occurred and a file was not sent correctly. Wait until sending is retried automatically after the preset interval. If the sending fails again, consult the network administrator.
Sending the data has failed. To confirm the result, check [Scanned Files Status].	<p>While a file was being sent, a network error occurred and the file could not be sent correctly. Try the operation once more.</p> <p>If the message is still shown, the network may be crowded. Consult the network administrator.</p> <p>If multiple files were sent, use the Scanned Files Status screen to check for which file the problem occurred. See p.58 "Checking the Status of E-mail", p.71 "Checking the Status of Scan to Folder", or p.94 "Checking the Status of Delivery".</p> <p>If there is not enough free hard disk space in the client computer, gain the enough free hard disk space.</p>
The destination list has been updated. Specified destination(s) or sender's name has been cleared.	A specified destination or sender's name was cleared when the destination list in the delivery server was updated. Specify the destination or sender's name again.
The E-mail address entered is not correct. Please re-enter.	Make sure the e-mail address is correct, and then enter it again.

Message	Causes and solutions
The entered path is not correct. Please re-enter.	Make sure the computer for destination and the path, and then enter if again.
The specified group contains some invalid destination(s). Do you want to select only valid destination(s)?	The specified group contains some destinations for sending by e-mail and sending by Scan to Folder. To select destinations for sending by e-mail, press [Select] for the warning displayed on the e-mail screen. To select destination for sending by Scan to Folder, press [Select] for the warning displayed on the Scan to Folder screen.
Updating the destination list. Please wait. Specified destination(s) or sender's name has been cleared.	If a destination or sender's name was already selected, re-select it after this message disappeared.
Updating the destination list has failed. Try again?	Check whether the server is connected.

When an Error Message Appears on the Client Computer

This section describes the main possible causes and actions for error messages displayed on the client computer when the TWAIN driver is used.

Note











- r If an error message that is not contained in this section appears, turn off the main power switch of the machine, and then turn it on again. If the message is still shown after scanning is performed again, note the content of the message and the error number (if listed in the table), and contact your service representative. For information about how to turn off the main power switch, see *General Settings Guide*.

Message	Causes and solutions
[Cannot add any more scanning mode.]	The maximum number of modes that can be stored is 99. Delete unneeded modes.
[Cannot connect to the scanner. Check the network Access Mask settings in User Tools.]	The access mask is set. Consult the network or scanner administrator.
[Cannot detect the paper size of the original. Specify the scanning size.]	<ul style="list-style-type: none"> • Place the original correctly. • Specify the scan size. • When placing an original directly on the exposure glass, the lifting/lowering action of the ADF triggers the automatic original size detection process. Lift the ADF by more than 30 degrees.

Message	Causes and solutions
[Cannot find the scanner. Check if the scanner main power is on.]	<ul style="list-style-type: none"> • Check whether the main power switch of the machine is turned off. • Check whether the machine is connected to the network correctly. • Deselect the personal firewall function of the client computers.
[Cannot specify any more scanning area.]	The maximum number of scanning areas that can be stored is 99. Delete unneeded scanning area.
[Clear Misfeed(s) in ADF.]	Remove the originals jamming. When the originals are misfed, place them again. Check whether the originals are proper to be scanned by the machine.
[Cannot add any more scanning mode.]	Check whether the client computer can use the TCP/IP protocol.
[Error has occurred in the scanner.]	Check whether the scanning settings made with the application exceed the setting range of the machine.
[Error has occurred in the scanner driver.]	<ul style="list-style-type: none"> • Check whether the network cable is connected correctly to the client computer. • Check whether the Ethernet board of the client computer is recognized correctly by Windows. • Check whether the client computer can use the TCP/IP protocol.
[Fatal error has occurred in the scanner.]	An recoverable error has occurred in the machine. Call your service representative.
[Insufficient memory. Close all other applications, then restart scanning.]	Close all the unnecessary applications running on the client computer.
[Insufficient memory. Reduce the scanning area.]	<ul style="list-style-type: none"> • Reset the scan size. • Lower the resolution. • Set with no compression. See p.21 "Send Settings". <p> Note</p> <p>r "The Relationship between the Resolution and the Scanning Area" chart in Help for halftone scanning might not always apply. Scanning cannot be performed if large values are set for brightness when using halftone or high resolution.</p> <p>r When a paper misfeed occurs in the machine during printing, scanning cannot be performed. In this case, after the misfed paper has been removed, proceed with scanning.</p>

Message	Causes and solutions
[Invalid Winsock version. Please use version 1.1 or higher.]	Install the operating system of the computer or copy Winsock from the operating system CD-ROM.
[No response from the scanner.]	<ul style="list-style-type: none"> • Check whether the machine is connected to the network correctly. • The network is crowded. Wait for a while, and then try to reconnect.
[No User Code is registered. Consult your system administrator.]	Access is restricted with user codes. Consult the system administrator of the machine.
[Please call your service representative.]	An unrecoverable error has occurred in the machine. Call your service representative.
[Scanner is in use for other function. Please wait.]	A function of the machine other than the scanner function is being used such as the copier function. Wait for a while and reconnect.
[Scanner is not available. Check the scanner connection status.]	<ul style="list-style-type: none"> • Check whether the main power switch of the machine is turned off. • Check whether the machine is connected to the network correctly. • Deselect the personal firewall function of the client computers.
[Scanner is not ready. Check the scanner and the options.]	Check whether the ADF cover is closed.
[The name is already in use. Check the registered names.]	You tried to register a name that is already in use. Use another name.

Specifications

Scan method	Flatbed scanning
Scan speed	<ul style="list-style-type: none"> E-mail/Scan to Folder/Network Delivery Scanner 51 pages/minute [Scan size: A4 , Scan type: Text (Print), Resolution: 200 dpi, Compression (Black & White): On (MH)] TWAIN Scanner 46 pages/minute [Size: A4 , Mode: Standard, Resolution: 200 dpi, Compression (Binary/Halftone): Data compression (MMR)]
Maximum power consumption	1440 W
Image sensor type	CCD Image Sensor
Scan type	Sheet, book
Interface	Ethernet interface (10BASE-T or 100BASE-TX), IEEE 1394 (IP over 1394) [optional], and IEEE 802.11b (Wireless LAN) [optional]
Maximum scan size	A3/297 × 432 mm, 11 × 17 inches
Scan size that can be detected automatically	<ul style="list-style-type: none"> Exposure glass 11" × 17" , 8.5" × 14" , 8.5" × 11"  ADF 11" × 17" , 8.5" × 14" , 8.5" × 11" , A4 , 5.5" × 8.5" 
Resolution	600 dpi (8-bit grayscale)
Variable range of scan resolution	<ul style="list-style-type: none"> E-mail/Scan to Folder/Network Delivery Scanner Setting range: 100 dpi, 200 dpi, 300 dpi, 400 dpi, and 600 dpi TWAIN Scanner Setting range: 100 dpi - 1200 dpi
File formats that can be sent by e-mail	TIFF, JPEG, PDF
Compression method	Binary: TIFF (MH, MR, MMR) Grayscale: JPEG
Protocol	Network: TCP/IP Sending e-mail: SMTP Scan to Folder: SMB, FTP

INDEX

A

Automatic Tilt Correction, 98
Auto run program, 25

C

Checking the status of delivery, 94
【Check Modes】key, 8
【Clear Modes】key, 8
【Clear/Stop】key, 9
Compression (Black & White), 21
Compression (Gray Scale), 21

D

Default Scan Settings, 16
DeskTopBinder V2 Lite, 29, 31, 95
Destination List Display Priority 1, 20
Destination List Display Priority 2, 20
Destination List Settings, 14, 20
Display Contents
 E-mail, 10
 Network delivery scanner, 11
 Network TWAIN scanner, 11
 Scan to Folder, 10
Display panel, 8
Divide & Send E-mail, 22
Document Server, 5, 73

E

E-mail, 3, 45
E-mail Information Language, 22
【Energy Saver】key, 8
【#】Enter key, 9

F

File Type Priority, 21
FTP server, 4, 64
Function keys, 9
Function status indicators, 9

I

Image density, 16
Indicators, 9
Initial scanner setup, 13
Installing software, 25
【Interrupt】key, 8

L

LDAP server, 4

M

Main power indicator and power indicator, 8
Max. E-mail Size, 22
Max. Number of Addresses Which Can Be Specified and Files Which Can Be Stored, 103
Mixed Original Sizes Priority, 18
Mode, 96

N

Network delivery scanner, 6, 85
Network TWAIN scanner, 7, 95
Not specifying a time limit for additional originals, 43
Number keys, 9

O

Operation switch, 8
Original Feed Type Priority, 18
Original orientation and scan area, 39
Original Orientation Priority, 18
Original Setting, 18

P

Placing on the exposure glass, 36
Placing original in the Auto Document Feeder (ADF), 37
Preview, 97
Print & Delete Scanner Journal, 21
Printing to the image, 98
【Program】key, 8
Programs, 23

R

Relationship between File Type Specified and File Type Used When Sending E-mail, 102
Relationship between resolution and file size, 99
Resolution, 16

S

Save, 97
Scanner Features, 13
Scanning mode registration, 98
Scanning originals, 96
Scanning Originals in Several Times, 42
ScanRouter V2 Lite, 32
Scan Settings, 13, 16
Scan size, 16
Scan to Folder, 4, 59
Scan type, 16
Selecting a custom size, 19
Select Title, 20
Sender's Name Default, 22
Send Settings, 14, 21
Simultaneous Storage and Delivery, 93
Simultaneous Storage and Sending by E-mail, 57
Simultaneous Storage and Sending by Scan to Folder, 70
SMB, 4, 63
SMTP server, 3
Software supplied on CD-ROM, 29
[Start] key, 9
Storing Files, 73

T

Troubleshooting, 104
TWAIN Standby Time, 21
Type2045e TWAIN Driver, 30

U

Update delivery server destination list, 20
[User Tools/Counter] key, 8

V

Viewing a list of stored files in DeskTopBinder V2 Lite, 79

W

Wait Time for Next Orig.: Exposure Glass, 16
Wait Time for Next Original(s): SADP, 17

